

A Tribute to Bob Pease

Pease Porridge – 7 (2008-2011)





What's All This Layout Stuff, Anyhow?

I've always been interested in the layout of things: bikes, cars, pc boards—and ICs. Sometimes it is just the compactness. Back in 1974, I got on a plane to San Francisco with my usual pad of quadrille paper, planning to draft (on the plane) an improved layout for a D flip-flop in CMOS. I got a couple of glasses of beer and soon concluded that I had no idea how to lay out a flip-flop. I went to sleep.

The next day, I discussed this with the Amelco guys, and they showed me their layout. I went back to my room and came up with a real good layout, noticeably more compact. Then the Amelco guys looked at it and made a couple small improvements. And then I added some tiny help.

Shortly we agreed there was no more room for improvement, and we were happy. One of the challenges was making this layout reasonably small, with minimum height, even if it was wide, so we could lay out a cascade of 16 flip-flops in a stack.

Other times, the layout of linear ICs gets more interesting—for all sorts of reasons. Matching. Thermals. There are more than 50 rules for making transistors and resistors that match. Some have to do with “dummy” resistors or “dummy transistors.” Or dummy metal. Sometimes these rules work well. Sometimes they seem to break down. Sometimes the rules contradict each other. Now what?

Many of you guys will recall my Oct. 1, 1996 diatribe about “Common Centroid Stuff” (see www.electronicdesign.com, *ED Online 6121*). A number of engineers had designed and published a computer program that (they claimed) could automatically lay out transistors or resistors to be “common centroid.”

But the computer program actually produced layouts that were not common centroid, just interdigitated. Making a common-centroid layout is usually very easy, using the rules of symmetry. A computer is no help at all. In fact, it's quite unnecessary. On rare occasions, a slide rule is helpful, because you can use its log scale for a measuring stick.

SITTING ON A PANEL • Recently, I was sort of invited to join a discussion panel of engineers on computer-aided design (CAD) and design automation for linear circuits. I thought about it. I've done this before. I've been on panel sessions at conferences. I recalled what happened.

There were some CAD guys who argued “Anything you can do, I can do better—and faster.” There was no way to rebut them. They set their own rules for what they thought was important. They did not want to talk about thermals. Or crosstalk. Or good grounds, even.

Nothing is less fun than a circuit that comes out of fab fast—and doesn't work right. I bet a lot of you guys will agree on that. So, hurrying is an *interesting* idea, but maybe

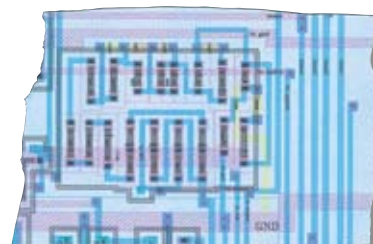
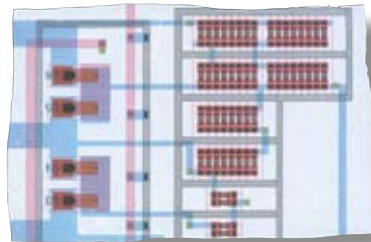

not a good idea. We have seen layouts that were done “as quickly as possible” but led to bad results. Hot transistors with varying quantities of dissipation, adjacent to critical transistors. Noisy busses laid out alongside (or on top of!) critical analog circuits. Or laid out alongside of busses that were going to critical analog circuits.

The art of knowing which circuits are critical isn't always written down, codified, or quantified. Some of those things are just wrapped up in the heads of experts. Young engineers usually need to get older heads involved in the layout, and this has

almost nothing to do with the schematic.

Getting the schematic to work, and to run in Spice, is hard enough. Getting it transformed into a good layout is another art. So I talked it over with a couple colleagues, and we all decided not to take part in that panel session. There's no point in going on a panel just to be the straw man that the CAD guys are going to be knocking down!

So I'm going to forecast that software guys and CAD guys will never stop bragging about how great they are, even though they cannot prove they are as good as they claim. I have been able to make some layouts that were very good. But I'm not permitted to brag about it. I can, however, help my friends make good layouts. This is true for pc boards, as well as for IC layouts—not to mention 3D layouts. ☺

Comments invited! rap@galaxy.nsc.com —or:
Mail Stop D2597A, National Semiconductor
P.O. Box 58090, Santa Clara, CA 95052-8090

BOB PEASE obtained a BSEE from MIT in 1961 and is Staff Scientist at National Semiconductor Corp., Santa Clara, California.



mailbag

DEAR EDITOR:
 At first I thought I picked up an April Fool issue, but no, you have Al Gore in the Tech Year in Review section honoring him for imploring engineers to turn green (*Dec. 1, 2007, p. 45; ED Online 17958*). What crap. Please cancel my subscription.
 —"RAY"

Hello, Ray: There are several reasons to "turn green," and Al Gore's bleating about warming theories is only one of those reasons. Energy is expensive. Or haven't you noticed?

Wasting energy is expensive. If you have an inefficient oven or refrigerator or hi-fi in your house, you may have to run your air conditioning harder and longer to get the waste heat out. That is expensive. And that applies to server installations and computer farms. And 100-W bulbs, too. So saving energy is going to continue to be important. (I don't even own an air conditioner. I do have a lot of 100-W incandescent bulbs, as warming up my house in San Francisco is almost always a good idea. Especially in the summer when it's cold outside...)

My boss is going to ask me to work on low-power and higher-efficiency designs. I better not plan to ignore him. My customers are going to ask me for lower-power circuits and systems. I can't tell them to bug off. They are my real bosses, as they pay my salary. My competitors are gonna beat me up if they can brag about lower-power products. I certainly don't want to get beat up by them.

I have always been in favor of making low-power products. Yes, I will sell you my LM137K regulator that will regulate 1.5 A, but I'd sooner sell you an LM337MP that puts out just 0.5 A, if that will make your system happy. I also designed an LM337LZ on an even smaller chip, for 100 mA, and an LP317LZ that ran on 2 mA quiescent, rather than 10 or 5 mA.

So you can say that, but at your peril. Go ahead. Tell your boss you don't want to work on "green" products and systems. I'm not gonna argue that you have to like Al Gore, but he is telling some of the truth. It ain't just politics.

And what is the opposite of "green"? Do you like to pay George Bush's friends \$3.59 per gallon? I don't know anybody who wants to do that while filling up their 38-gallon tank. But hey, you vote with your pocketbook, I'll vote with mine. /rap

HI BOB,

Years ago, you published a "mystery" circuit that consisted of just a transistor and a resistor, I believe. You applied a positive voltage, and it produced a small negative one. If I remember right, you explained (in the next issue) that one

junction was acting as an LED and the other as a photodiode. I've lost the issue. Could you give me the details again?
 —TERRY PERDUE

Hi, Terry: Take any NPN silicon transistor—metal can (2N2222) or plastic (2N3904) or even monolithic (LM114). Ground the base. Connect the emitter through 1k to +12 V so it will zener. (This may damage or degrade the transistor, so you should throw it away when you are done.) What is the V at the collector? A high-Z DVM will read -0.3 V. /rap

BOB,

I've tried using LEDs as light sources for microscopy, but the output was always too low. Now with the newer devices, I can get all the light I need from either the color or white sources with virtually no heat as compared to older incandescent sources. (Yeah, you can get a lot of light now. But if you used the right kind of mirrors or optics, even old incandescent bulbs would reflect the heat away... and put the light where you want it. /rap)

When using a low-voltage dc source, I just use a current-limiting resistor. But if I need to power directly from the 120-V ac line, I have been using a line-voltage-rated capacitor whose impedance limits the current. I don't seem to have any inrush current problems, and I usually put a small rectifier diode in reverse polarity parallel with the LED to avoid reverse breakdown. (If you put the LED in a bridge of four diodes, it can run on the current both coming and going through the cap. /rap)

Sometimes I just use another LED in reverse parallel. I have been doing the same for LED indicator lights in ac circuits as the power consumption is very low (mostly VARs), and there is little heat generated. I have not seen this concept used and wonder if I'm missing something or they are missing something.
 —OWEN MULKEY

Hello, Owen: If everybody did this, the power company would be very annoyed! But if just a few of us do it, no harm. It's a good idea to put ~1k in series with the cap to limit in-rush transients... and I usually put two line-rated caps in series, so if one fails shorted, you just get a little more brightness—and don't fry the 1k. /rap

Comments invited! rap@galaxy.nsc.com —or:
 Mail Stop D2597A, National Semiconductor
 P.O. Box 58090, Santa Clara, CA 95052-8090

BOB PEASE obtained a BSEE from MIT in 1961 and is Staff Scientist at National Semiconductor Corp., Santa Clara, California



What's All This Oscillator Stuff, Anyhow?

Anybody can make an oscillator these days at almost any imaginable frequency. But how do you make a good one at low power? A couple of people recently asked me why I add so much complexity by using an op-amp oscillator in my Cold Toe Detector. (That general-purpose slow oscillator is in the LH upper corner of www.national.com/rap/coldtoes.html.) “What kind of analog freak are you?” they asked. “Why don’t you just use a CD4060, which has a built-in oscillator?”

I responded that everybody knows that CMOS is a low-power way to do things—except when it does *not* provide low-power operation. If a CMOS analog circuit is designed to run at low power, it can be very efficient. But if it is not engineered for low power, it can waste a lotta microwatts.

CMOS amplifiers and oscillators are not inherently low-power, but run at low power only when designed to do so. Operated in a linear region, they can be very power-hungry. Conversely, bipolar transistor circuits can easily be designed to be quite efficient as they have more gm per microampere.

So I thought some more. If I want to design a 1-Hz clock, is the CD4060 really that bad and the op-amp oscillator that much better? And if a CMOS clock oscillator based on a CD4007 was optimized, would it have any advantages? Maybe it was time for me to build and measure some oscillators.

TIME FOR HOMEWORK

We had a guy at National who was really helpful and knowledgeable about oscillators. If any of us NSC guys or any customers had a question about oscillators, Tom Mills always made himself available to help.

Tom had the bad taste to die in his sleep about five years ago, leaving us bereft of a great engineer and a great friend—and

an oscillator expert. But somewhere up in Heaven, I am sure Tom is saying, right now, “That’s right, Bob. Do your darned homework. Build and measure things.”

The oscillator I built for the Cold Toe Detector to oscillate at 1.6 Hz was not optimized per se. I just grabbed the first low-power op amp that I could get, an LMC6041 (not the lowest-power one). I slapped on the R’s and C’s and it ran, just fine, and I thought little more of it until today.

As I observed in “What’s All This CD4007 Stuff, Anyhow?” back in April of 1999 (*see* www.electronicdesign.com, *ED Online 6073*), the CD4007 is a very versatile and powerful linear circuit. But to get the best results, you may have to do some real engineering.

- The original cold-toes oscillator (1.6 Hz) using an LMC6041 drew about 18 μA . I took all the data on my low-frequency “1-Hz” test oscillators running at 70 Hz to make it easier to average the current drain. I didn’t think that would change the power requirement appreciably from the current at 1 Hz—only a few percent. So we are in the right ballpark.
- The CD4060 self-oscillating counter/timer used about 180 μA . I used the cookbook circuit from the Fairchild CD4060 datasheet. I just used 10M, 10M, and 0.001 μF —not terrible, not wonderful.
- A basic MM74C14 Schmitt trigger used about 90 μA , using just 10M and 0.002 μF .
- The basic CD4007 circuit, per the figure, also used about 180 μA . That’s funny. I was hoping I could tweak it to do better than that. I fooled around with it. Those 2.2M resistors were not a great idea. Finally I made a lucky guess, and if I shorted out one of the 2.2M resistors, or the other, the drain would fall to 22 μA . But if I shorted both, it would go back up to 180 μA . Ha! The joke’s on me!
- I threw in a real low-power op amp, with a rated I_s of 2 μA , and the drain fell below 3 μA .
- A comparator is really the right way to make a low-power oscillator. I got one of our lowest-drain comparators, the LPV7215 at 0.58 μA , and put it into the basic oscillator shown in that Cold Toes circuit. It did the best job at 1.4 μA . Go ahead and beat that! ☺

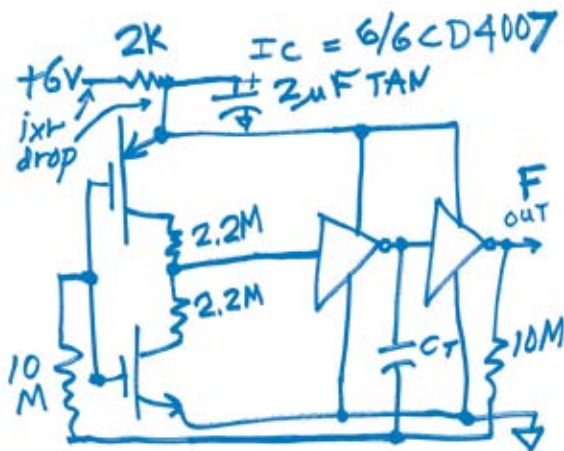

Comments invited! rap@galaxy.nsc.com —or:
 Mail Stop D2597A, National Semiconductor
 P.O. Box 58090, Santa Clara, CA 95052-8090

BOB PEASE obtained a BSEE from MIT in 1961 and is Staff Scientist at National Semiconductor Corp., Santa Clara, California.



mailbag

D

EAR RAP:

You answered one question for me last year (“Why are FETs so expensive in India?”), and I now have another. How does a bipolar op-amp-based non-inverting dc amplifier amplify dc signals that are below a 0.6-V bipolar threshold (e.g., an LM358-based non-inverting dc amplifier)?

(Okay, you want a gain of +1.5 or 2 or 3 for a small signal that is barely above ground, such as +0.1 or +0.2 V? And the LM358 uses a small +V supply such as +6 V and ground? /rap)

The op-amp datasheet schematics show no bias on the input Darlingtons. Representative schematics show a bias constant current source for the differential-pairs tail current, but none for the bases of the two input PNP transistors.

(The input PNP’s emitters run on the base current of the differential-pair transistors. If you build up this circuit using ordinary transistors, it will work. Of course, 2N3906s have higher beta, but the lateral PNPs in the LM358 do not have that high beta. So there is always some current to run those emitters on. Further, an extra current is often fed to the emitter of the input transistor—maybe only 1/2 μA , but enough to give that PNP some emitter current to run on. Note that the LM358 schematic is a “simplified” schematic diagram. Transistors are so cheap, we can add in another transistor as needed to make it work a little better. We can add a little more current to the inputs’ emitters. Note: LM358 inputs work down not just to +0.1 V, but also to -0.1 and -0.2 V of V_{CM} . /rap)

I have read all of chapter 7 in *Art of Electronics* as well as many other books that cover op-amp basics, but this particular question is explained nowhere. How are bipolar op-amp input transistors biased into conduction?

-ASHVINI VISHVAKARMA

HELLO, ASHVINI:

They just run on whatever current they can get from the following (differential) stage and from extra current sources. They don’t need a lot. Even 0.1 μA is plenty. If you open up an LM358H, you can see these current sources. Sometimes they are a part of the main 6- μA current source to the differential pair. Sometimes the transistors in the differential pair have two collectors and the smaller collector goes to its base, and thus to the input emitter. Either way will work. Both ways are used in various different amplifiers of this basic type. **-RAP**

SIR,

In a recent article, you said that too much beta decreases mu. I can’t find anything on this in my textbooks. Would you explain?

-RAYMOND A. FUTRELL

HI, RAY:

You may have mediocre textbooks. Mu is an alternate statement of (1/Hrb). When the beta goes sky-high, the mu and the voltage gain go low. It is related to the Early effect. Have fun.

-RAP

DEAR SIR,

As I am going to buy a testbench for electronic circuit testing, I want some feedback about isolated power and the ground plane arrangement. Can you suggest a layout?

-CHETAN VIRANI

HELLO, CHETAN:

You haven’t given me much info on what you are trying to do, so I can not exactly give you feedback. But in general, it is a good idea to put a big slab of copper-clad glass-epoxy material on top of the workbench with the copper side up and ground it to the neutral of the power line as a ground plane. I like to set up at least 12 to 16 power outlets for an ordinary bench with local circuit breakers. Then I would usually ground most of my circuits to that grounded copper. I might put cardboard or insulating glass-epoxy over the ground plane if I need insulation. When I am working with high voltages, I try to keep one hand in a pocket before I turn the line power on. I did a lot of work on high-voltage stuff recently, and I never got “bit.” You also mentioned isolated power. I rarely need isolated power. I do use an isolation transformer on rare occasions. I do sometimes use a line-power “three-wire-to-two-wire” cheater so I can float a scope or sine generator, but I am pretty careful when I do that. I hope these are useful ideas for you. **-RAP**

DEAR BOB,

I need to convert a 5-MHz sine wave to a 5-MHz TTL signal. Is there an IC that would do the job?

-RON RASPET

HI, RON:

Take a look at some comparators. There are lots of slow ones, but you’ll want one with delays less than 15 ns. The LM360/LM361 is fast enough. But you can pick one that gets along with your existing power supplies such as an LMV7219. **-RAP**

Comments invited! rap@galaxy.nsc.com —or:
Mail Stop D2597A, National Semiconductor
P.O. Box 58090, Santa Clara, CA 95052-8090

BOB PEASE obtained a BSEE from MIT in 1961 and is Staff Scientist at National Semiconductor Corp., Santa Clara, Calif.



What's All This LED Power Stuff, Anyhow?

Recently, NSC put on a webcast with Howard Johnson, NSC's Chris Richardson, and some guys from Philips and Future. As they had set it all up and presented it at the last minute, I didn't know what points they were going to make. When they made their pitch, it all made perfect sense—but I wasn't prepared to contribute very much. I sat there like a "fifth wheel," not making many comments.

But I did set up one experiment, which wasn't shown on the webcast. I put a pair of Hershey's chocolate bars (without almonds) on a couple of little supports. A good, bright LED array shone on one, and a high-brightness incandescent lamp of the same lumens shone on the other.

The candy bar under the LEDs warmed up about 1° and would sit there forever. The one under the incandescent lamp melted and collapsed in about 55 seconds. So this was another convincing argument that the heat from an incandescent lamp goes out in a completely different mode than the heat from an LED, which comes out of the heatsink in the back of the LED and isn't radiated at the objective, where the light is shining.

Later, a couple of engineers asked, "Okay, but how much more efficient are LEDs than incandescents?" Chris dug up some numbers to show that good white LEDs can provide white light with 40% to 60% less power than the incandescent bulb that did such a good job of melting the chocolate bar. But after I thought about this, I realized I had another good point.

GETTING GOOD EFFICIENCY

Chris showed that to get good efficiency from LEDs, you have to use a switching regulator specifically designed for current regulation. It can accommodate any reasonable range of V_{IN} and put out an ampere or two at a voltage such as 16 V, which is about the voltage of a stack of five white LEDs in series. But the switcher doesn't regulate the voltage. It regulates the current.

The voltage can move around as conditions change, temperature or whatever. Fine. The efficiency of the switcher is about 86%, so even though there are some losses there, the LED system needs less power than the incandescent. Fine. But during the webcast, we talked in general of the nominal volts and amps. When the customer began asking about real applications, I made my point:

- At "Nominal Line Voltage," an incandescent lamp has a certain output in terms of lumens, perhaps 15 to 25 lumens per watt. This could be at 115 V ac or 117 or whatever. An automotive lamp might be defined with a typical voltage of 13 V dc in a car. A switcher for LEDs puts out a regulated output to the LED, which may provide 50 to 60 lumens/W.

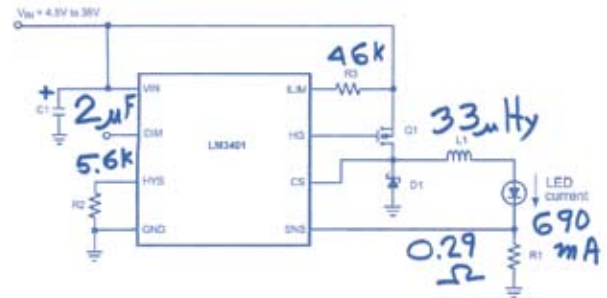

- Now let's go to high line, such as 125 V ac or 14.4 V dc. The incandescent bulb puts out a lot more light—the voltage factor of (1.09 x) is taken to the ~fourth power. It also draws more power. Is that good for you? Fine. But beware that the life of the incandescent bulb is then decreased by the ~eighth power of 1.09. Can you live with that?

Many incandescent bulbs are already running so hot that their life is only five or 10 hours. Most modern (incandescent) flashlights run a 2.2-V bulb at 2.9 V, which gives you great efficiency and very good light output—and poor bulb life.

Meanwhile, the LED output is constant. The switcher IC may have to work a little harder. Its efficiency may swing a little, but the LED is regulated, and its light output is regulated within better than 1%.

- Now let's go to low line. The LED output (lumens) is still constant. The switcher IC has to change its duty cycle, and its efficiency may change a little—up, down, who cares? The incandescent lamp at low line has considerably better life than it did before. But its light output shrinks at the ratio of 0.92⁴, which is a considerable shrinkage. Is that acceptable for you?

Incandescents are changing all over the place. The lumens/watt change around grossly, though the LED is regulated. So for worst-case study, the incandescent bulb has a lot of variation, and the output lumens are going to have broad variances versus line.

The actually available lumen output is poorer at low line. The bulb life is poorer at high line. So the usable efficiency of the incandescent bulb is even worse than in typical conditions—unless you run it from a switching regulator, too! ☹

Comments invited! rap@galaxy.nsc.com —or:
Mail Stop D2597A, National Semiconductor
P.O. Box 58090, Santa Clara, CA 95052-8090

BOB PEASE obtained a BSEE from MIT in 1961 and is Staff Scientist at National Semiconductor Corp., Santa Clara, Calif.



Mailbag

H

BOB:

I would like to ask about designing a sine-wave amplitude attenuator with programmable attenuation. Preferably, it will just contain basic components (op amps, transistor, resistors, caps, etc.). Input: 1-V p-p sine wave (1 kHz frequency), symmetric at 0-V level. Desired output: still at 1 kHz, but the amplitude varies from 0 to 1000 mV.

-JOERICH SUNICO

HELLO, JOERICH:

For the last 30+ years, the multiplying digital-to-analog converter (MDAC) has been a good way to do this. A 10-bit MDAC will attenuate a 1024-mV p-p sine wave to any amplitude such as 1023, 1022... 1001, 1000, 999, 998... 637, 636, 635... down to 1 and 0 mV p-p. These days, nobody builds their own MDACs because the ones you can buy are so good. You can also get 8- and 12-bit MDACs. Can I recommend a part number? How about the DAC101S101 (bus-compatible)? Look it up at National's Web site at www.national.com.

Now if you have decided to take on a project, to reinvent the wheel and make your own DAC, to use hundreds of parts to generate the same function as two chips (the DAC and the op amp), be my guest. But nobody has been publishing circuits on how to do this for 30 years, because the item you buy for \$2 is so much better.

You could put a string of 1000 22-Ω 1% resistors in series. You could put in 999 switches. You could decode the digital code. You could do it in binary or in BCD. You could make it very accurate. You could solder day and night. But that's just to show that if you had a time machine, you could go back to 1950 and make your own MDAC. Bulky, slow, expensive. Have fun.

I did design a 10-bit MDAC module around 1972. But it had to have low phase shift at 1/2 MHz, very fast settling, and low glitches. And to this day, that is not easy to do on one chip. It was 2 by 4 by 0.39 in. high, and it was beastly to make. We finally figured out that the customer had made a mistake when he wrote up the specs, so we got out of the contract and sent him something else that made him happier.

-RAP

HI BOB,

I recently purchased some germanium TO-3 power transistors just for fun to see if I am smart enough to use them. The newer IGBTs, etc., are wonderful. You can switch lightning voltages (almost), and they are certainly the way to go. But I have an old CD ignition system that I have had on three old cars over the course of 23 years, and I picked it up off a junkyard car when it was 20 years old. So 43 years of use with germanium power transistors under the hood says something for a design.

I have noticed the old TO-3 transistors have a very nice lightweight aluminum low-profile case. It must be good for heat transfer, corrosion, and weight savings. Why were steel cases ever used for TO-3 transistors? Steel is heavy, it offers poor heat transfer, and it rusts. Could cost be that high for aluminum?

-CRAIG RIPPLINGER

HI, CRAIG:

Aluminum TO-3s are cheaper and used when the customer wants the lowest price. The thermal impedance is about the same as steel. (Aluminum is only better as a heatsink on a per-ounce basis.) But the weakness of aluminum TO-3s is for thermal cycling. Even with the best die attach, after about 5000 full-range (150°C to cold) temp cycles, the die attach gets flaky and turns into a cold-soldered joint, and the thermal impedance goes way up. If you're running a high-power application, as you might if the temp cycling is extreme, the die can overheat. In the steel package, the life is 40 times longer, or more. If you don't run the die to 150°C, on an LM317, the degradation is much less. If you only go to 85°C, which most germanium can stand, the degradation is much lower. In a "transistor ignition," the germanium transistor's die will rarely get above 45°C, so it will last a very long time. At National, we haven't made aluminum TO-3s for more than 20 years.

-RAP

BOB,

Your suggestion in your Feb. 28 column to connect a solid copper ground plane to the neutral conductor of the power line is dangerous. Although the neutral conductor is nominally at earth potential, load currents through the impedance of this line will raise the neutral conductor and ground plane above earth potential. This will become worse if the neutral connection becomes flaky or if there is a fault and the lines are improperly fused, which is more likely on an experimenter's workbench. Instead, the ground plane should be permanently bonded to green-wire ground. A ground-fault circuit interrupter on the mains should also be used.

-MATTHEW GRAEN

HELLO, MATTHEW:

Thank you for the correction.

-RAP

Comments invited! rap@galaxy.nsc.com —or:
Mail Stop D2597A, National Semiconductor
P.O. Box 58090, Santa Clara, CA 95052-8090

BOB PEASE obtained a BSEE from MIT in 1961 and is Staff Scientist at National Semiconductor Corp., Santa Clara, Calif.



What's All This AMT Stuff, Anyhow? (Part 2) *

I've often heard that if you're going to owe the Alternative Minimum Tax, there's nothing you can do about it. And that makes me scream! Most of these officious statements say you can postpone some income and defer the AMT, but you'll just pay them next year. "There's nothing you can do to avoid the AMT." It's a lie!

I was absent-mindedly reading some of the boilerplate on some of my other investments. "You might like to buy some AMT-free bonds," Dreyfus said. I instantly perked up my ears and investigated. I've looked up some Dreyfus funds, and I am also checking into Citicorp, "Black Rock," and Fidelity.

It's true that these bonds may pay a lower rate than conventional bonds, but that is not a big deal. It's also apparently true that there aren't any (at this time) AMT-free bond funds that are California-only, and thus entirely free of federal and state taxes and the AMT. But I don't mind paying some taxes, so long as I can start to get out of paying so much AMT.

ACCORDING TO MY GUY...

My friend in the stockbroker business says he can avoid the AMT as well as state and federal taxes by buying a specific bond issued in California. (Whatever state you live in, do your homework.) To do this, you may have to make a \$5000 minimum initial investment. I mean, I don't mind paying my fair share of taxes, but the AMT rates are absurd, with hardly any fair deductions or exemptions permitted.

For example, after I pay my state taxes, my ordinary 1040 federal gross taxable income (line 38) would be improved by deducting those state taxes. But the AMT forces me to pay federal (AMT) taxes on my state taxes. That's not fair.

The 6251 form indicates that you just pay a 28% tax rate, but that's another lie. After you put in the surtax multipliers, the incremental tax rate can go above 44%, and the base exemption is only about \$66,000 for a joint return. You can get shafted real fast by the AMT—not to mention that you can get ruined by other obscure, hidden, unfair tax rates as high as 85% per the Social Security benefits worksheet.

Specifically, you don't just add and "combine" the data on lines 1-27 on line 28 of form 6251. If your income is above 207.5k, you take the total that should go on line 28, multiply the excess over 207.5k by 25%, and put that into line 28, so every \$1000 increase in your income can cause a \$1250 increase in taxable income on line 28. (This would normally require another worksheet, but the AMT guys want things to look simple.)

Further, as your income increases, your exemptions (on the page 7 worksheet) decrease, so your taxable income goes up again by another \$312.50. Then, down at the deductions worksheet, this \$1000 increase, too, is multiplied up by $-(-3\%)$,

so you are paying a "28%" tax on \$1592. It results in a \$446 increase in your taxes, for a 44.6% tax rate—and that is before you start paying state income taxes. (Does your state have an AMT state tax, too? Lucky you!)

WHAT TO DO?

If you do a Web search for AMT-free bonds, you can start learning. Ask for a prospectus. Obviously, I can not recommend any particular fund. But I have invested some of my long-term retirement funds in these AMT-free bond funds. Note that books and magazine articles keep saying that you can't avoid the AMT, and I am absolutely fed up with their lies!

If you got advice on how to avoid AMT on your investments, you read it here, not there. I bought a couple of big \$30 tax books published by Lasser and by Ernst & Young. They claim "We'll tell you things the IRS doesn't want you to know." But they don't tell you one word about AMT-free bond funds. Ahem. I puke in their lousy, lying briefcases.

If you are at all skeptical, just add an extra \$1000 to your income, run that through your computerized tax program (or your tax expert), and see how your tax changes. Plug another \$1000 into your capital gains, and see how that changes things—especially in your AMT. Surprise! Have you seen your 2007 tax forms yet? As I write this, I have not seen mine.

Maybe you can print yours at www.irs.gov. But the mailman will just barely bring yours, in the nick of time, because Congress was so slow to settle this AMT matter in December, and its members aren't happy about being forced to make decisions on tax law that will make so many people unhappy.

You don't have to be rich to get shafted by the AMT. Just sell a little stock, or receive some capital gains. I haven't done all the math, but a lot of taxpayers will be very unhappy when they learn that they have to pay thousands of dollars of extra taxes. And they, too, will be furious about being lied to.

The AMT is not going to be reformed or indexed properly anytime soon, because doing so would cause the loss of many hundreds of billions of dollars of revenue. And nobody can figure out how to plan any reforms, as they can't imagine how to replace all that revenue. ☹

*See part 1 at www.electronicdesign.com, ED Online 11374.

Comments invited! rap@galaxy.nsc.com —or:
Mail Stop D2597A, National Semiconductor
P.O. Box 58090, Santa Clara, CA 95052-8090

BOB PEASE obtained a BSEE from MIT in 1961 and is Staff Scientist at National Semiconductor Corp., Santa Clara, Calif.



Mailbag

HI

HELLO BOB,

A note concerning electric cars and plug-in hybrids: Consider that politics has little to do with engineering and/or science. It only pays lip service at those altars. So, somebody has to do serious planning for the immediate future.

I've been working on some serious battery-charger designs. One of our planners (an engineer) did some research in good old California. We learned that your utility companies have problems with metering even small numbers of plug-ins, nor can the California infrastructure absorb many cells of even 5000 plug-ins. You're running at about 81% capacity, and without a smart meter and control, we would easily overload the electricity capacity on two peaks every day. That's not politics. It's business.

American, Japanese, and European manufacturers were contacted, and none of us can really do this without the cooperation of the utilities. Oh sure, we can sell a few and look green. The press wouldn't even know who to blame when the grid broke. Some of our competitors have been doing that, but without that smart meter, it's the wrong thing to do. They know it. But that's business.

All of the automakers easily agreed on the meter and protocol. The utilities did not. They already have contracts on meters that aren't smart. That's business. The real greenies were there, too. They're part of politics. They want California to be energy neutral in 10 years—sorry, no data on how to do it. Industry must be hiding it.

Back in the Midwest, we run about 1/2 the total power per person aggregate (at 740 W per person continuous) than you do out west, but that's because of our low transport and air conditioning costs. Perhaps just targeting our levels would be a better starting point. There is no magic bullet in the next 10 years. So the utilities answer to the greenies and business, not to the engineers. Our charger is going to be great. We will get patents. It will be used all over, but not in volume in the west.

—AN ANONYMOUS ENGINEER

HELLO, ANONYMOUS:

I've always been suspicious of the "visionaries" who think it is going to be so great to have lots of electric cars, plug-in hybrids, and hydrogen-powered cars. Who is going to build the electrical generating and power-transmission capacity for recharging a lot of cars? Who is going to make the hydrogen fueling stations and the hydrogen generators?

Not the same people who are smoking bad stuff and dreaming improbable dreams. Thanks for reminding us. Right now, the only thing saving us from these problems is the high cost

and limited availability of such cars. If we got more such cars, we would not be able to drive them to work the next day after a little heat wave.

—RAP

DEAR MR. PEASE,

I've often used components in various packages: TO-92, TO-220, and so on. Usually, these components are pulled off the shelf without any thought to the package they are in apart from obvious questions such as "Will the package handle the power to be dissipated?" (Oh, I disagree! We engineers usually pick a part in a (compact) package that makes some sense for the task at hand. We don't pick a 20-W package to do a 28-mW job, nor vice versa. And if I ever tried to do that, when I was a kid engineer, my boss would have chewed me out. So we all have to learn somewhere. I mean, who ever went to school to learn about heatsinking? /rap) I've been wondering, though, what the history of these packages is. (It is obvious that each package is a compromise of all those terms, so TO-92 (and its variant packages) will dissipate almost a watt—just before the thing dies! /rap) Who designed each one? (Probably 34 different JEDEC committees... /rap) Why did they choose the particular shape it is? (Surely, because the guys who said they could make it argued that it was a feasible package to make in high volumes profitably... with good results for the users. /rap) What were the tradeoffs that had to be made during development? When did it first get used and why? (I wasn't there. How the hell would I know? /rap) There seems to be absolutely no information on such things. I'm sure an awful lot of R&D went into those packages, but it just seems to have disappeared, leaving only the application information (such as package drawings) behind.

—JOHN DALTON

HI, JOHN:

On the contrary. The history has dried up, but the facts remain. These packages remain as examples of packages that have been, some of them, very popular—in the dozens of billions! Which other packages have you considered? The TO-2, TO-4, TO-6? TO-91? TO-93? Who the hell ever heard of them? Nobody! And guess why? I doubt if there are many survivors of that era who would like to talk about their struggles with these packages, are there? But all of the packages that survived were subject to the realm of *feasibility*.

—RAP

Comments invited! rap@galaxy.nsc.com —or:
 Mail Stop D2597A, National Semiconductor
 P.O. Box 58090, Santa Clara, CA 95052-8090

BOB PEASE obtained a BSEE from MIT in 1961 and is Staff Scientist at National Semiconductor Corp., Santa Clara, Calif.



What's All This One-Transistor Op-Amp Stuff, Anyhow?

One day, back about 1966, I was going up the elevator at 285 Columbus Avenue in Boston to look at some production problems on Philbrick's fifth floor. And who was in the elevator, but George Philbrick's friend Jim Pastoriza.

Jim was going up to show George his new analog computer demonstrator—portable and battery-powered. In fact, it was running, and he gave me a demo right on the elevator as we ascended. And, this modular analog computer ran on a couple of Jim's new one-transistor op amps.

This is not an April Fool's joke. This is not a hoax (see the figure). I don't think anything ever came of that amplifier, though. Nobody else ever heard of it. It was never published. It was obviously the result of some kind of a bar bet. George must have bet a big bar bill on whether such an amplifier could be built. And Jim was gonna win the bet!

HISTORY ALMOST REPEATS ITSELF

I did see the schematic of that amplifier, and it was very much like the one shown here. But I never did see the internals of the amplifier's construction. Since I just remembered this amplifier after more than 40 years, I decided to re-create it. I got a group of likely looking transformers and tried to get them to ring when tickled. They would not ring with any decent Q when tuned with 1000 pF.

Finally, a friend had pity on me and loaned me a good, small (1.1-in.) Carbonyl C toroid. (Carbonyl is pure iron in powder form, embedded in a neutral matrix.) When wound with 60 turns, it had good Q . I put on a few more turns and lashed it into the circuit shown. It oscillated nicely at 0.7 MHz, using a 2N3906. (Jim had used a 2N384-type, which is a little hard to find these days.)

Then I added in the galvanically isolated "front end" with the V47 varactors, with the 220-pF feedback to the base of the PNP. I was able to wiggle the dc voltage at the negative input and modulate the amplitude of oscillation—and to move the dc output voltage a little. I fooled around with various variable capacitors, and trimpots, too, and twisted-pair capacitors. I got the "gain" up to 0.2 and then 0.4.

I borrowed our best "twiddle box" and it helped, as the capacitor had a knob on it. The 1.9k in series with 68 pF was rather touchy, but I got the gain up to 12. Then I added a little PFB with the 24k/5k divider. (I could get high gain in a small region, but it was not very linear, and even then, it had good high gain mostly when V_{OS} was as gross as 0.5 V.) Finally, I got the gain error down to ± 0.1 V for a ± 1 -V output swing.

Jim had said his gain was up at 1000. I was hoping I could get the gain up to 100, but none of my tricks could get it up

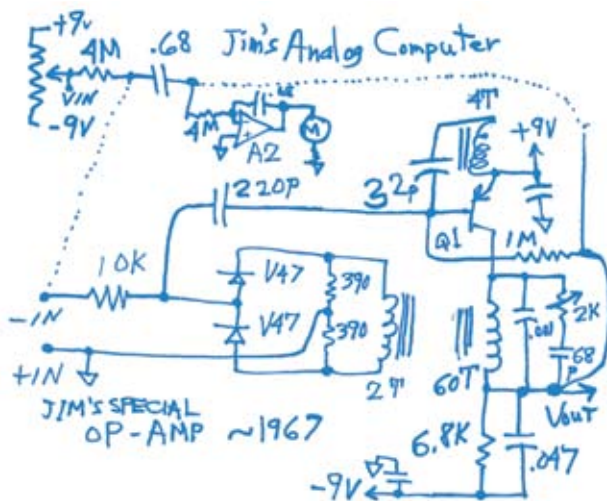

there. Jim was a good engineer, and he knew a lot about varactor amplifiers, but maybe he never really got it to 1000. But it works okay even with a gain of 20.

THE RESULTS

Anyhow, I set up the big one-transistor kluge along with another low-power FET op amp as "A2" and ran them as an analog computer as Jim had showed me on the elevator. If you look at the output of A2, it starts out pegged. If you turn the V_{IN} pot, you can bring the meter to a balanced state, but it's moving fast. Can you manipulate that pot to get and keep the meter on-scale? After you understand that this is simply a double integrator, and after you practice a bit, it's not very hard.

So, here is a little analog computer that you can use to practice closing the loop around a double integrator. And now you see that a one-transistor amplifier is not a hoax! Improbable, yes, but usable in a pinch. I haven't given up on getting good gain, but I'll spend no more time on it for now.

One of my friends reminded me that there's one thing worse than a circuit with too many transistors, and that's a circuit with too few transistors. Yeah, that's true. But back in 1966, using a small number of those expensive transistors wasn't a terrible idea. If I could only get the gain a little higher! ☹

Comments invited! rap@galaxy.nsc.com —or:
Mail Stop D2597A, National Semiconductor
P.O. Box 58090, Santa Clara, CA 95052-8090

BOB PEASE obtained a BSEE from MIT in 1961 and is Staff Scientist at National Semiconductor Corp., Santa Clara, Calif.



Mailbag

H

I BOB,

Any big trips to exotic spots planned this year? We're headed for Newfoundland and Prince Edward Island for a change of pace. (I may go to Scotland in September. /rap) My question: Do you have some circuitry I could use for an electronic bagpipe simulator? It would need nine notes selected by removing fingers from some form of contact that would reasonably simulate a finger hole. I don't need too many specifics, just a broad idea and maybe a part suggestion. I believe the reference frequency (low A) is around 46 Hz. The notes run from low G to high A on a Mixolydian scale. There are also three drones: two tenors tuned to low A and a bass tuned to an octave below low A. The intent here is to "pipe" the noise directly to earplugs so as not to annoy my dog, and of course my wife. I do have a practice chanter that is nowhere nearly as loud as the pipes, but it's still loud enough to cause irritation to some members of the household. There is debate on whether the bagpipes create music or just organized noise. **-DON RUMRILL**

HELLO, DON:

I've heard that you can buy a "practice" bagpipe. Don't any of your friends who have bagpipes have a simulator? I don't know much about circuits for music simulators, or even noise. I'd hate to have to reinvent that wheel. Aren't there any books on how to make synthesizers? Good luck. **-RAP**

HI BOB,

What do you know about op-amp nonlinearity? (I just happen to know *everything* about op-amp linearity. I've almost finished writing a 25-page app note on linearity, and I have measured dozens of good op amps. Will 0.1 ppm be good enough? I think the LM4562 will be about the best. Go to www.national.com/rap and look for the LM4562 datasheet. /rap) I have an application that requires extreme dc linearity, like sub-ppm. I need positive gain in the range of 4 to 10 with input between -0.4 and +0.4 V, multi-G Ω input impedance, and minimal noise with source resistances from 100 Ω to 1 k Ω or so and bandwidth from about 0.1 to 10 Hz. It seems that so-called "crossover distortion" (For many good op amps, the crossover distortion is quite negligible. /rap) may be a dominant nonlinearity and can be alleviated by drawing a constant current from the output using a CRD to the negative supply, or something like that. Are there other types of nonlinearity I should watch for, and how might I deal with them? Thanks! Keep up the great work. **-RICK WALKER**

HI, RICK:

Ask me another question after you read the app note. **-RAP**

HELLO ROBERT,

I'd like to short out a resistor. Well, not exactly short it out, but reduce its resistance to the channel resistance of MOSFETs. The problem is one end of the resistor is at 5 V, and the other end can be as low as 0 V or as high as +5000 V. Is there a way to connect MOSFETs in series to reliably do this? There are FETs on the market with breakdowns as high as 1500 V. I can't use a relay for a variety of reasons. **-PETER BERG**

HELLO, PETER:

I am not an expert on this. I know that people with high-V switching to do sometimes stack up several high-V FETs and turn them on with photo-pulses with a photodetector at each gate. Call up the people who make the 1500-V FETs and ask them how to turn on a stack of four of them with simultaneous photo-pulses. They will know better than I do, as there may be some tricks. **-RAP**

HI BOB,

Silly question: When I look at a noise spec in nV/Hz, do I use equivalent bandwidth times spec or square root of equivalent bandwidth? **-ED SIMON**

HELLO, ED:

It is not nV/Hz but nV/ $\sqrt{\text{Hz}}$. Let's say you have an amplifier with 20 nV/ $\sqrt{\text{Hz}}$ in the flat band. Let's also say you have an audio bandwidth of 10 Hz to 20 kHz for the -3-dB points. If the rolloff is a smooth 6 dB per octave above 20 kHz (simple single break, not a lot more rolloffs), the noise bandwidth will be $\pi/2 \times 20$ kHz, or 31,416 Hz. A good book on noise will remind you about that factor of $\pi/2$.

After you subtract the 10 Hz also $\times \pi/2$ (about 16), the effective noise BW will be about 31,400 Hz. The sqrt (31,400) is about 177.4, and then you multiply that $\times 20$ nV, which will be 3.55 μV rms, referred to input. So the output noise will be about (gain) times 3.5 μV . If the gain is +10, you would have 35 μV of output noise. That's how you use the sqrt. (If you have a gain of -10, the noise gain will be 11, so you would have 39 μV at the output. This all assumes the resistors are low enough to not contribute to noise. $R_{IN} = 1\text{k}$ or lower will contribute less than 4 nV/ $\sqrt{\text{Hz}}$, which is negligible, as $4 + 20 = 20.8\dots$) **-RAP**

Comments invited! rap@galaxy.nsc.com —or:
Mail Stop D2597A, National Semiconductor
P.O. Box 58090, Santa Clara, CA 95052-8090

BOB PEASE obtained a BSEE from MIT in 1961 and is Staff Scientist at National Semiconductor Corp., Santa Clara, Calif.

Bob's Mailbox



May 27, 2008 12:00 AM
Electronic Design
Bob Pease

Bob,
On the subject of TO-3 power transistors (<http://electronicdesign.com/Articles/ArticleID/18429/18429.html>), steel and aluminum packages were mentioned. I think y'all were referring to all steel (mounting plate and cover) or all aluminum. *(Actually, the "steel" TO-3s had a nickel cap. /rap)* Those aluminum ones were just too high and always alien-feeling to me. *(Yeah, but they may have had lower thermal impedance! Aluminum has better thermal conductance than iron by four times. /rap)* The TO-3 packages that I remember weren't built that way. A file to the mounting flange revealed a thick slab of copper with a steel cover. *(I am ignorant of copper TO-3s. Maybe there were some. I never heard of any. /rap)* Those TO-3 packages of the 1960s and 1970s were heavy and I'd imagine had the best thermal impedance specs of the lot. It may be that the all-steel, all-aluminum packages appeared when IC dies were being installed in them. Who wanted the package to cost 10 times what the electronics cost? Would it be that the packagers of the mundane crap at Wal-Mart would take the hint?
Dean Huster

Dear Dean,
I know nothing of Wal-Mart. I never go in there.
RAP

Hi Bob,
I know I tend to be a little thick-headed at times, but I must be having a particularly tough time lately. I've been staring at your circuit, which measures really low levels of distortion (<http://electronicdesign.com/Articles/ArticleID/14109/14109.html>) and have a couple of questions.
To quantify the amount of distortion in the amplifier, would you feed the signal at the false summing junction (labeled 1000 VE) into a spectrum analyzer and subtract 60 dB from each of the values at the harmonics? *(That is one good way to do it. I've done that and it works. But actually, you can just barely see the second harmonic, slightly under the noise. /rap)*
Would the lower spur values then represent the performance the amplifier would have with a gain of -1 at the test frequency? *(Yeah. You might be skeptical of your powers of analysis, but actually you did figure it out just right! /rap)* I can't quite grasp what the scope display would represent when connected to the vertical and horizontal test points.
(Ahh, then you should build up this test circuit someday! I mean, you barely have to solder four resistors! Then look at the waveforms. Also, plug in some mediocre amplifiers. After studying them, you will say "Ah, that does make sense!" /rap)

The horizontal channel would have an inverted input signal plus distortion *(In theory, yes, a little distortion. But the amount of distortion is so tiny, well below 1%, there's nothing visible. /rap)* while the vertical channel should only have distortion plus some low-level residual input signal. If there were zero distortion, I guess you'd see a horizontal flat line. *(Or at least a slightly titled straight line. Or an ellipse. /rap)* With some distortion, there should be some height to it. But how do you interpret what you see?
(You subtract all the linear terms, and what is left, p-p, is usually quite small. That is the distortion. Within a week, I can send you a big app note, AN-1485, which is almost finished. You will see dozens of examples! /rap)

Sorry for being a doofus!
Robert J. Barden

Dear Robert,
No, you are just cautious when somebody tells you four potentially unbelievable things before breakfast. You got it right!
RAP

Dear Bob,
There is a thing more annoying than a circuit done fast that is not working—a circuit that is known to not be properly working but going to production anyway. *(Ouch! /rap)* I am just now sitting over a design that I pointed out to have a bad printed-circuit board (PCB) layout several years ago. Nonetheless, the customer has been producing this circuit unmodified since it works most of the time. Now they have found a situation where it does not work at all and they need a fix fast. *(Circuits that are intermittent will drive you crazy, but things that are really not working are much easier to fix! /rap)*

The problem in this case is that the designer of the PCB used an auto-routing tool for everything. *(I will not let auto-routers screw up critical connections like that. I keep critical components in good places. /rap)* The result (among other flaws) is a power and ground layout where the capacitors and the chip are electrically connected, but traces between them are too long and the main blocking capacitor is outside the current path. *(Obviously, this is disastrous! /rap)*

Also, the hint to have a direct connection between the two ground pins of the chips has been ignored, and the actual connection goes through several vias and way around the chip instead of straight under it. Unfortunately, I do see a lot of this kind of PCB layout. Many people do rely on their CAD system instead of their experience. (Maybe there is nothing to rely on.) I wonder if they ever heard of parasitic effects and RF behavior. My first rule for checking PCB layouts is that if they look chaotic, they are usually not good.

An anonymous engineer

Dear anonymous,
I usually look at it the other way. If it is too neat and orderly, I expect that to be no good!
RAP



What's All This Current-Source Stuff, Anyhow?

Recently, a guy asked me how to draw a constant 1.00 mA from a node of a circuit. Of course, he did not tell me what volts, ohms, or frequency. But, he admitted, he basically did not know how to design a current source.

So I'm sorry to waste the time of all you guys who do know how to design a current-source. But maybe this lecture can help and save you some time so you don't have to teach all the young kids. If you need a current source, and you don't know where to look, it is not easy to find advice on how to make them. I looked and could not find valid advice on how to do this! So, here you go.

STEP BY STEP

Figure 1 is a basic (unidirectional) current source that can spit out any positive current you want. You want 10 or 100 μ A? 10 or 100 mA? 10 or 100 nA? 10 or 100 A? Be my guest. It does a good job, putting out current in one direction—but not both.

The current sourced is $I = V_{IN}/R$ (Fig. 1a). Of course, you need an op amp whose common-mode (CM) range extends to the right voltage and whose I_B is small enough. For current sourcing, you need an amplifier whose CM range and output go approximately to the positive rail, and you need PNP transistors. Sometimes you can arrange it so the output does not have to go too close to the rail, using a resistive divider. The transistor is shown in a nominal way.

For 1-mA full-scale current, an ordinary 2N3906 can give you a Z_{OUT} of 50 M Ω . If you want a really high Z_{OUT} , like 1000 M Ω , you might put in a Darlington (Fig. 1b). Or for large currents, a Trarlington could be justified. If you need to put current into a fast-moving signal, you might need to add some extra cascoding to I_{OUT} .

For sinking current, you need an amplifier whose CM range (and output swing) extends to (or near) ground, or $-V_S$ (Fig. 1b). And, you need an NPN transistor. This is often called a constant current source.

Well, it does not have to be absolutely "constant." It can be "modulated" or adjusted by changing the V_{IN} . You could put in some ac. But don't allow the current to get "modulated" to zero, or you might get some strange response from the unhappy amplifier.

A Howland current pump can put out positive or negative current—or zero (Fig. 2). Then there is the "improved" Howland current pump (Fig. 3). Both are wonderful when you have defined what ranges of V and I you want. Neither one has a great weakness, depending on what you want. If you want the output to go close to the rails, the "improved" Howland can usually be arranged to swing closer.

SOME EXTRA INFO

I recently did a complete analysis of the Howland circuits, and I wrote it up as an Application Note, AN-1515, at www.national.com/an/AN/AN-1515.pdf. I included some notes on trimming the resistors, because many times the Howland is

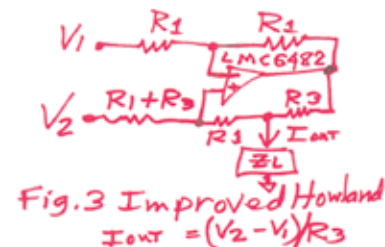
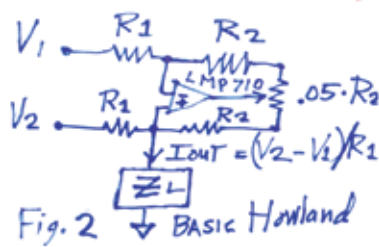
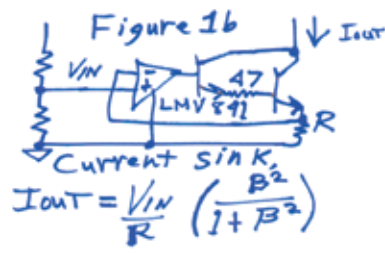
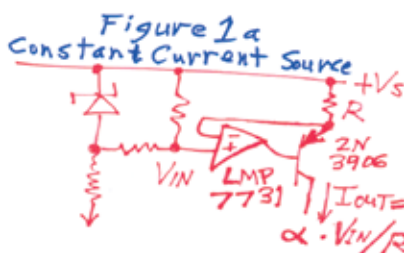

just presented as a nominal circuit, with no trimming indicated. But to get high Z_{OUT} , you usually do have to trim.

For a 1-mA output (all R 's = 10k \pm 1%), the Z_{OUT} might be as poor as 0.25 M Ω , +0.25 M Ω or even -0.25 M Ω . So, you have to trim. (See the little trim on Figure 2. Even 0.1% resistors would only provide a moderate improvement, to \pm 2.5 M Ω .) That App Note also shows how to get high Z_{OUT} without any pots. ☹

Comments invited! rap@galaxy.nsc.com —or:
 Mail Stop D2597A, National Semiconductor
 P.O. Box 58090, Santa Clara, CA 95052-8090

BOB PEASE obtained a BSEE from MIT in 1961 and is Staff Scientist at National Semiconductor Corp., Santa Clara, Calif.



Mailbag

H

I BOB,

I have been collecting some new but mostly museum-grade test instruments. Along with purchases from various instrument rental houses, flea markets, and so on, for a while I bid on items in government liquidation auctions. Occasionally, I won. The starting bid was always \$50, and some I got at that price. Some went way higher but seldom approached the original list price, and I gave up way before that. Often, the shipping costs to a pickup and forward agent were more than the purchase price. (Check. /rap)

Last year, the government changed the rules and started wanting something called EUC (end use confirmation, or whatever) on anything of interest to me. I filled one of those pain-in-the-you-know-what "Paper Work Reduction" forms. Then I stopped buying anything more. (Check. I hate those lawyers, bureaucrats, nit-pickers. /rap) To my astonishment, during the past few weeks, I have been demanded to fill in more forms for purchases in 2006 as well as 2007. The items included a Fluke 8060 handheld DMM. (When Fluke 8060s are outlawed, only outlaws will have Fluke DMMs. /rap)

Worse than that, I had to return an HP 3400A true RMS (analog) volt meter. It had been suddenly reclassified as a Class "Q" item, which means that it had to be destroyed when I returned it. (What a damn shame. I think I would hide the damn thing at a friend's house for a couple of years and tell them it didn't work and I trashed it. I'd lie to save it. Or, I would sell it to a person who would give it away to save it. /rap)

Apparently, in their great bureaucratic wisdom, somebody has concluded that this 1960s technology is dangerous to U.S. national security! Yes, it has this marvelous 10:1 crest factor, when the present day handheld DMMs only have 3:1. But is that a good reason for becoming a secret? Or is it the neon tube chopper/demodulator, which is the one aging component in the design? (Uh, yeah. "We had to destroy the (village) to save it." /rap) Or maybe the government is in dire need of the nuvisitors. There is one in the front end of this meter. (Oh, they better not come after my nuvisitors. Mine are matched! I matched them in my matching fixture 40 years ago. /rap)

As it happens, that model of meter was the very first item that I convinced my at-that-time employer in Finland to purchase for our engineering group. We needed it when we developed SCR-based motor drives for our manufacturing machinery. It was around 1968. So, in free distribution worldwide, eventually obsoleted, and now a dangerous secret. How could Bill Hewlett and Dave Packard ever have guessed? (Geez, too bad you can't tell that to HP. They'd probably get you arrested for harboring a high crest factor! /rap)

Oh yeah, that meter was part of a three-item lot that I won at \$50. The refund I'll get is prorated with the original price ratio of all items in the lot. I think I'll get \$7. The over \$200 that I paid for agent services would be treated the same way, prorating, if I had a receipt. The only place that receipt appears is on my credit card statement, but that included actually two lots at the same time—not likely to be sorted out if I even tried.

Another item that I can imagine a little better being recalled is a TEK 1502 reflectometer that I got in a March 2006 auction. There was no mention of destroying it in the recall. I think it is the version that still contains a tunnel diode "heart." When did you last try to buy a tunnel diode? So maybe even the government can't waste any of them.

-PELLERVO KASKINEN

HELLO, PELLERVO:

What a nuthouse. It would make Jim Williams sick. Hey, hide the damn things. **-RAP**

HI BOB,

I was amused by how fast you go from an e-mail answer to your column. (Sometimes they go fast. Others, not. /rap) I assume you are aware that now that you can make a better op amp, the analyzers can get better. (But my (analog) analyzers can measure things better than committed analyzers. Take a look at AN-1485. Go to www.national.com/rap, search for AN-1485, and print it out. /rap) I just finished testing to see how the lead-free solders compare to the audiophile ones. I had to use three LME49740s to test this. (We try to put good plating over the tin, so whiskers will not grow, but a sample of three is not enough to prove anything. Have you seen our official position on lead avoidance and tin whisker avoidance? /rap) The results were not surprising: 63/37 was better than 60/40, 62/36/2, and 96/0/4. Maybe, kind of, not a real clear result. I will let the test samples age to see if anything grows. **-ED SIMON**

HI, ED:

Maybe you can avoid the tin whiskers, but I don't think you can make an absolute guarantee based on a sample size of three, times 28 months. That's barely good enough for a satellite that has to last more than four months. **-RAP**

Comments invited! rap@galaxy.nsc.com —or:
Mail Stop D2597A, National Semiconductor
P.O. Box 58090, Santa Clara, CA 95052-8090

BOB PEASE obtained a BSEE from MIT in 1961 and is Staff Scientist at National Semiconductor Corp., Santa Clara, Calif.

Bob's Mailbox



June 30, 2008 12:00 AM
Electronic Design
Bob Pease

Hi Bob,

The plug-in hybrid seems like the best immediate transportation solution. *(Yeah, but we ain't got enough (a) cars, (b) batteries, or (c) power to recharge them all. /rap)* My engineering solution for California is a smarter power meter that rations power to your charging car. *(Yeah, but that meter does not yet exist. /rap)*

If the power demand is high, your car will charge in proportion to how much stuff you turn off in the household. It is up to each power user to decide whether to charge the car or run the air conditioner. This would bring green reality to each household. *(Yeah, but at my house, even if I turned off everything but one LED flashlight, I might not be able to get enough charge to get to work the next day. /rap)*

Each home would get an equal ration of power. We could call it the Green Piece of Power. When the grid gets to full capacity, the brownout starts with the highest over-ration users. *(That is a very fine concept, but it would need a very sophisticated meter—and I don't think we know how to make that meter. And if we did, the electric companies and the customers might not agree to it. /rap)*

After being the dark, hot house in the neighborhood a few times, increasing home power conservation will become a status symbol. *(My "air conditioning" runs off the Pacific Ocean and requires no amperes at all. /rap)*

Personally, I have over a foot of insulation in the attic, double-pane windows, and the biggest, most efficient air conditioning condenser in the neighborhood. During air conditioning season, we cook outside and limit inside power dissipation as much as possible. There is a connection between money conservation and being green. *(Agreed. But sometimes it takes a lot of money to save money. Not everybody has that money. /rap)*

Putting ethanol in gas tanks is a waste. My solution is to drink the ethanol and walk.

Tom Cater

That one, I like. Or, ride a bicycle. Best regards. –RAP

Hi Bob,

As a former electrical engineer from the 1950s and 1960s, I've been a long-time admirer. So I was surprised to see your letter in Electronic Design stating "Who is going to build the electrical generating and power transmission capacity for recharging a lot of cars?" California peak load during a normal summer day is about 43 GW. The max load is 50 GW. Nighttime summer load runs around 25 GW. *(On a really hot night, the demand for electricity doesn't taper off much. Here in San Francisco, it gets warm, but not warm enough to bother us. My air conditioning comes straight off the Pacific Ocean. It costs me zero amperes. /rap)*

That leaves about 25 GW of off-peak capacity, which would power a maximum of 3.7 million cars in California. (Chargers pull about 6.7 kW.) *(They can pull a lot more than that. And, there are a lot more cars than 3.7 million in California. If 10% of those cars were replaced by plug-in hybrids, the grid would go down on the first hot night. I think I will hold on to my Beetle just to be safe. I believe that Tom (above) is right, that we'd need chargers that are smart enough to charge per priorities. An electric car would be screwed if it couldn't get much charge at night. A plug-in hybrid would just have to buy some gas. As I said in my column on this 12 years ago, the owner of an electric car could buy a gas engine as an accessory! /rap)*

It also solves a big problem for the power-generating utilities who have to inefficiently throttle back their generators during off-peak. *(A lot of places have pumped storage, such as Northfield Mt. in Massachusetts. Is there none of that in California? We got big hills and high reservoirs. I'll have to look into this. /rap)*

On the plus side, you sure got the hydrogen "boondoggle" right. The production, storage, and transportation of hydrogen is a nightmare under the best of circumstances, but the economics of generating hydrogen is so poor as to be laughable. I think the current cost is about \$12 to \$15/equivalent energy gallon. *(And every time the price of gasoline rises, the price of hydrogen is thus ratcheted up, with that same brutal factor. Maybe we can get George to subsidize the cost of hydrogen. I'd love to, but I can't afford the taxes. /rap)*

All you need to do is look at the electrical energy required to electrolyze water and break the hydrogen bond. It takes four units of electrical energy to produce one unit of equal hydrogen energy. Talk about inefficiency! You may as well use the electrical energy to directly charge batteries. It's four times as efficient. *(Check. But those batteries are heavy to drag around. Maybe since George is so smart, he can figure out how to avoid that. Maybe he can invent the helium battery, even lighter than lithium. /rap)*

Ditto for reforming hydrocarbons to make hydrogen. You would be better off using the gas directly. Either way, you're generating the same pollutants, except you can scrub them easier in large central facilities. And, most people don't know that oil refineries are the biggest users of electrical power in California. I'm not sure of the exact number, but I think it's over 20%. That's more electrical capacity that would be available if there was a reduction in gasoline production.

Malcolm Field

I doubt if we are going to worry about that very soon. Thanks for the comments and advice and good technical points. –RAP

P.S. I have heard that water pumps are the biggest users of electricity in California—pumping for farmers and pumping water to Los Angeles. That might be true. –RAP



What's All This Sudoku Stuff, Anyhow?

I suspect most of you have seen these “logical” puzzles in many newspapers (not to mention little books). They consist of putting numbers into squares so each big square of nine squares has every number, one through nine. Likewise, so does every row and every column.

The easy ones are too easy, and the hard ones are substantially impossible. But the moderate ones are fairly challenging and satisfying. Sudoku is a big time-waster, and I won't recommend anybody to take it up. But if you have some time to burn, well, sudoku will take up a lot of it. Each puzzle may take 20 to 60 minutes—if you don't make any mistakes.

How come my wife can do a puzzle, but when I try it and get stalled, she can't show me where to find the next legal move? A move that she surely just made? Maybe she can't recall where to look for the next move. Last night, I was working on a five-star puzzle, and I found it easy. She started on the same puzzle, and she got stuck! She could not find the next legal move.

It took me about nine minutes to find the legal moves that would let her continue. It was, of course, in the ~ last place I looked. She had overlooked a couple of small moves. Then she had no problem finishing it. But it sure was challenging for me to find that move!

TIPS AND TRICKS

I hate to guess. Many very difficult or five-star puzzles force you to guess, because after a while, there are no unique legal moves you can make. (Or, to be precise, too many legal moves, and none that is uniquely permitted.) I have looked for advanced sudoku techniques, but most of them aren't helpful.

Recently I've decided to cheat a little and put in one number from the published solution. I can usually finish most of them if I make a reasonable guess of which number to choose.

Some books recommend using “Ariadne's Thread,” which is just a form of guessing. You make your guess and see if the puzzle plays out. If it doesn't work, you “back up” to where you got stuck and started guessing. I do this by putting a small number in the lower right-hand corner of a square. If that doesn't work, I put my second guess in the lower left-hand corner. If that doesn't work, I give up.

My wife does them with pencil and eraser. I use a ball-point pen and just cross out numbers that have become forbidden. She likes to work on a grid about 0.75 in. square. I find that very hard, and I use a grid that's 1.2 in. wide by 0.9 in. tall, as big as I can fit on a 8.5- by 11-in. sheet.

She likes to start by putting in all the easy numbers when there are several numbers given. I like to start with the ones and progress right up to the nines. That way, I know that a tiny number between a four and a six must be a five. But that does not explain our differences. We have checked several times, and even though we use different techniques, we come to the same intermediate states. Usually.

GETTING A DO-OVER

Sometimes I find I have made a mistake. I wish I could take back a lot of my moves, sequentially, back to a certain point where there are no errors and then start forward again. But without an infinite amount of record-keeping, you can't back up a sudoku game.

Can I get a computer program to let me “back up”? To enable me to go back and see where I made a mistake? And then

list all the “possible” numbers and erase them when they become forbidden? Most computers aren't set up for this. I don't want a computer that can play the game for me, but I think it would be fun to document the flow. Easier to back up! And I am certainly not going to start writing software for a project as monstrous as this!

Sometimes a two-star puzzle can be quite hard or tricky. Sometimes puzzles that are alleged to be four or five stars can be easy. These “ratings” are quite

arbitrary and inconsistent. Beware of some “Latin Squares” that look like a sudoku but may have two or more solutions. I once did a “monster” sudoku that was four by four by (four by four) squares, but I don't need to do that very often. Maybe if I'm stuck on a desert isle.

Anyhow, it is a nasty time-killer. When I have a short plane trip, I bring several sheets of graph paper so I can do the puzzles from the airline's in-flight magazine. When I have a long flight, it just ruins my spare time!

And I promise to not bore you about my adventures solving cryptoquips. But these, too, make pretty good mental exercises to keep your mind sharp. ☺



Comments invited! rap@galaxy.nsc.com —or:
Mail Stop D2597A, National Semiconductor
P.O. Box 58090, Santa Clara, CA 95052-8090

BOB PEASE obtained a BSEE from MIT in 1961 and is Staff Scientist at National Semiconductor Corp., Santa Clara, Calif.



Mailbag

H

I BOB,

I am trying to build a test circuit that will produce a pulse current from a capacitor. My target is around 200 A at 100 ms. Is this possible? We have an instrument called a PVI that does the same only at lower current and at shorter duration, but I don't know how it is being controlled. I hope you can give me advice or a basic control circuit that I can start working on.

-ROMMEL C. VILLON

HELLO, MR. VILLON,

You have not told me what the load voltage or resistance is, but I made a first guess of a couple volts. I started to try a capacitor of 20,000 μF at 20 V. I almost computed that the cap voltage would drop 1 V. Wrong. Per $I = C \, dv/dt$, it would drop 1000 V. If 200,000 μF , it would drop 100 V.

So, you might need 2,000,000 μF . (Farad supercapacitors would not put out that current.) You then would need 100 20,000- μF caps in parallel, charged up near 20 V. This is not quite the same as a car battery, but it deserves the same kind of respect. Don't drop any wrenches near the high-current terminals.

You'd need more than a dozen transistors with emitter ballast to get the currents to share. Put them in a Trarlington. Get a fast op amp to turn them on crisply—and off. I think you ought to start at 20 A and scale up by making the transistors 10 or 20 wide. This is a lot of charge! Be careful. Things may blow up. Get your head and body 20 feet away behind a tempered glass wall when you trigger it.

Maybe 12-V batteries will work best, with two or three in parallel. I mean, every time you start your car, you have transients like that, but into a 9-V load (the starter). Make sure you have fuses that are appropriate, because if the transistors fail, you will have a vicious current flow through the melted transistors. And, use a remote-control disconnect switch. Get the idea? Have fun! (You might set up a big relay to automatically disconnect it all after 0.15 s just in case there is a failure.)

You did see my column (*June 12, p. 60*) on current sources, right? But the art of extending a 2-A current to 20 and then 200 A is not simple. It is not just electronics. It is the art of management of high currents.

-RAP

DEAR RAP,

Remember that current-monitor circuit you drew up in your error-budget article (*June 8, 2006, p. 18*)? First, if I invert the pnp, it still seems to work. Can you explain? Second, suppose I would like a negative voltage current monitor. How would you change the circuit for that?

-PETER BERG

HI, PETER:

First, some pnps have some reverse alpha, but not as good as 99%. Maybe 40% or 70%. So, the gain might not be right. The gain might be lousy. Also, the V_{BE} breakdown is certain to be much smaller, so it would not work at 10 or 20 or 30 V. It might seem to work at 4 or 5 V. Think about it.

Second, if you wanted to bring up a signal from nearly -15 V, representing an $I \times R$ drop near -14.95 V, that is easy. You would need an npn transistor, and you would need an op amp whose common-mode (CM) range goes near the negative rail. This would bring the signal to a volt or so below the ground bus.

What if you wanted to bring this signal near a volt above the ground rail? If you want that, let me know. What do you have for a positive rail? What do you want to do with the signal? Feed it to an analog-to-digital converter? This would become an analog problem, and you should start writing down what you want. Needing and wishing are two different animals. Defining what you need is a good idea.

-RAP

BOB,

I saw your note about the LM4562 (*May 22, p. 80*), and I read the datasheet. I'm curious about the application circuit from page 25 of the datasheet for a sinewave oscillator. Is that an incandescent lamp used as a circuit element? (Exactly. /rap) Can you tell me why this would be used?

-LLOYD SLONIM

DEAR LLOYD,

A lamp's filament has a big positive temperature coefficient. This oscillator will start oscillating and the amplitude will grow—until the lamp gets warm and then stabilizes at a certain amplitude. Hewlett & Packard started out their whole business with their HP200 oscillator, which used this principle, designed in 1939. Ancient history. Not very modern.

-RAP

HI BOB,

Solving an electronic circuit design problem while keeping the component count as small as possible is similar to solving a puzzle (*May 8, p. 64*). I like it! Good work!

-"HAMURO"

DEAR HAMURO,

Thanks!

-RAP

Comments invited! rap@galaxy.nsc.com —or:
 Mail Stop D2597A, National Semiconductor
 P.O. Box 58090, Santa Clara, CA 95052-8090

BOB PEASE obtained a BSEE from MIT in 1961 and is Staff Scientist at National Semiconductor Corp., Santa Clara, Calif.



What's All This Output Impedance Stuff, Anyhow? (Part 1)

A few engineers were having a debate. According to all the books, some of them said, op amps are supposed to have zero output impedance, or very low. That means the output voltage won't change, just in case the output current changes. Some older op amps had an output impedance of 600 Ω or 50 Ω . So, the gain of the amplifier won't change just because the load changes. That must be good.

But a couple of other engineers pointed out that many modern op amps have a very high output impedance. The advantage of high output impedance (for the op amp) is that when the load gets lighter, the gain goes up. Is there any harm in having a higher gain?

Sometimes it's advantageous to have high gain, and higher gain isn't necessarily bad. This high output impedance usually occurs on rail-to-rail outputs, which are "drain-loaded." You can't have an emitter-follower or source-follower output on a rail-to-rail output! If you did, it wouldn't swing rail-to-rail.

A FOOLISH IDEA

Let's have a little more insight on this gain stuff. "Nobody needs an op amp with gain higher than 200k," I once heard one foolish engineer say. "Besides, nobody would want to measure an op amp's gain at 2 million or 6 or 10 million, because it would take many seconds of test time, at 0.1 Hz or slower, and nobody wants to pay for that test time."

Wrong! We can test op amps for a gain of 1 million or 10 million in just a few dozen milliseconds. We read the summing-point voltage, put in a suitable step, and wait a couple milliseconds for the summing-point voltage to settle. Then we wait a few milliseconds more, read the changed voltage, and average for a few milliseconds more (perhaps for 16 ms).

The voltage gain is related to the reciprocal of those few microvolts of error. We measure gain for a step, not for sines. So does everybody else in the industry. The settling time is related to the amplifier's gain bandwidth, not to its low-frequency "pole," which is just a fiction.

This same guy argued that when you use an op amp with a gain of 2 million or 10 million, "You can only see higher accuracy when you have signals well below 1 Hz." Wrong again! If you put in a +1-mV square wave at 10 Hz into a good op amp set up with feedback resistors for a gain of +1000, the amplifier with 2M will settle in a few milliseconds to 999.5 mV.

The output for the gain of 20M will settle to 999.95 mV. If you had a gain of just 200,000, it would settle to 995 mV. Even with sine waves at 10 Hz, you can see the difference in better gain accuracy. The output would be 999.5 mV or 999.95 mV p-p, not 995 mV p-p, even at 10 Hz! Higher gain is better.

A SECOND OPINION

"If an op amp has a high gain at rated load, and its output impedance is high, then the gain gets higher when the rated load is taken off," another engineer argued. "The dc gain goes up, and then the gain rolloff will be steeper, and you'll get more phase shift, which will make the loop less stable."

Well, I haven't seen any op amps whose rolloff gets steeper when the rated load is taken off, not for 35 years—an amplifier whose phase-shift goes bad. All modern op amps have Miller feedback from the output, so when the gain gets higher, the low-frequency break just goes back even further—even slower than 0.01 Hz. I've seen that a lot. So, there's no danger there if the gain gets "too high." A gain of 1M or 10M or 100M does no harm.

What is an example of an op amp where the gain goes up when the rated load is taken off? A lot? The LMC662 or the LMC6482. These are CMOS amplifiers with ~ "rail-to-rail" output capability. Of course, it makes a difference how the output is controlled.

If there is a Miller integrator (capacitive feedback loop around the output stages) to make the gain rise smoothly at low frequencies, that can make the gain smooth indeed. The gain could rise smoothly at 6 dB per octave, even back below 1 Hz or 0.1 Hz.

Okay, where is the proof of the pudding? What does the gain look like? What does it do for a closed-loop gain of 10? More in the next issue!

The real performance of an op amp driving a load is also related to the g_M , or transconductance. If an op amp can't put out much current, no matter how you try, then it won't have good performance when you ask it to drive heavy load currents. That's generally true if the Z_{OUT} is high or low. You gotta have some g_M . (As the old trucker used to say, you can't climb hills with paper horsepower.)

Let's look at examples of both types. If the load is lowered, does it hurt the gain accuracy? The distortion? If the load is lightened, does it hurt the gain accuracy? The distortion? The settling time? In the next column, we will put these questions to the test using the test circuit shown for the "best" amplifier of 2006 (see "What's All This Best Stuff, Anyhow?" at www.electronicdesign.com, ED Online 14109). ☺

Comments invited! rap@galaxy.nsc.com —or:
Mail Stop D2597A, National Semiconductor
P.O. Box 58090, Santa Clara, CA 95052-8090

BOB PEASE obtained a BSEE from MIT in 1961 and is Staff Scientist at National Semiconductor Corp., Santa Clara, Calif.



What's All This Output Impedance Stuff, Anyhow? (Part 2)

When I present seminars, I often ask the members of the audience to hold up their hands if they think bipolar op amps have better gain and linearity than CMOS. I get a good majority of hands. But neither is bad!

The good-old LM301A (well over 30 years old) has a good gain of 260,000 at no load, with just 75 μV p-p of gain error while its output is swinging 20 V p-p (Fig. 1). What happens when we put on a load? With its rated 2k load, the gain falls and even reverses a little and becomes nonlinear in its error.

The lower curve shown here (with a 1k load to exaggerate the error) shows that the LM301A's nonlinearity becomes as big as 48 μV p-p. This isn't due to low "gain" or g_M , but to thermal feedback from the output transistors to the input transistors, which is caused by imperfect layout of the temp-sensitive input transistors.

Well, this does look lousy, but there are mitigating factors. This thermal effect is most obvious at 0.2 to 20 Hz. At frequencies above 150 Hz, this effect tends to go away and smear out, and at 1 kHz, you can hardly see it. So, this isn't a big problem for audio amplifiers.

Also, if the amplifier isn't driving heavy load currents, this thermal problem shrinks proportionately. At light loads, it's negligible. Even with a 4k load, an LM301 can make a unity-gain inverter with a nonlinearity of 1.2 ppm. At lighter loads, it's even better.

Where can you learn more about this thermal crosstalk? At Application Note AN-A, written by Jim Solomon. If you go to www.national.com/rap and type AN-1485 in the search space, it explains this thermal feedback and also tells you how to find AN-A. So, even bipolar amplifiers with "low" output impedance can have imperfect gain and linearity due to thermal feedback from the output transistors to the input stages.

ON THE BENCH

Now let's look at some CMOS amplifiers with ~ rail-to-rail outputs. The LMC662 is typical—one of our first CMOS amplifiers

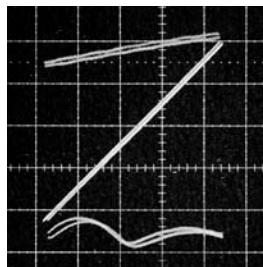

1. Crossplots of gain error, with test circuit per AN-1485: LM301A, $F = 5$ Hz; output ± 10 V into 1 k Ω (lower trace); upper trace, 75 μV p-p at 100 $\mu\text{V}/\text{div}$.; lower trace, 48 μV p-p at 100 $\mu\text{V}/\text{div}$.

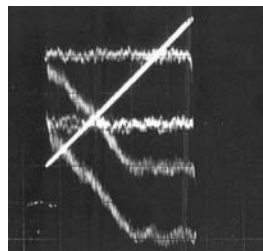

2. LMC662, $F = 6$ Hz; output ± 4 V into 1 k Ω (lower trace); upper trace, 1 μV p-p at 10 $\mu\text{V}/\text{div}$.; lower trace, 27 μV p-p at 10 $\mu\text{V}/\text{div}$.

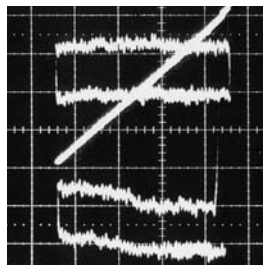

3. LMC6042, $F = 0.6$ Hz; output ± 4 V into 1 k Ω (lower trace); upper trace, 2 μV p-p at 20 $\mu\text{V}/\text{div}$.; lower trace, 6 μV p-p at 20 $\mu\text{V}/\text{div}$.

(Fig. 2). Like the LM301A, its gain degrades when overloaded with 1 k Ω . But the nonlinearity (deviation from best straight line) is only 18 μV p-p. That's not bad for an 8-V, 8-mA p-p swing.

This isn't thermal cross-talk, just a matter of honest gain. The LMC662 has four honest gain stages to source current, but just three stages to sink load current. Still, its high output impedance causes the gain to rise a lot when lightly loaded. How high does it rise? Well, it seems to rise higher than 4 million, but the error is down in the noise. As with the LM301A, its distortion when driving a 4k load is about 1.2 ppm.

So, it really is possible to get low distortion with ordinary op amps. And, it's easy to get exquisite linearity with good, inexpensive amplifiers. For example, the LMC6022 does better than 0.3 ppm (Fig. 3). That's pretty good for a micropower op amp. Its open-loop Z_{OUT} is above a megohm, but its closed-loop Z_{OUT} is below a milliohm!

NEWER AND BETTER

Now, I've shown you some of our worst and oldest amplifiers with the worst distortion and the poorest gain. If you want to see some of our newer and better amplifiers, with better distortion down to 0.03 ppm, go to www.national.com/an/AN/AN-1485.pdf.

In this app note, I explain the gain curves of dozens of op amps. Be sure to look up the low-voltage LMC6042 and the full-voltage LME49720, for example. They are better than 0.3 ppm nonlinear! Appendix A on pages 22-23 of that app note lists many op amps, using both CMOS and bipolar transistors, with nonlinearities from 2 ppm down to 0.3 and even 0.03 ppm. All were tested using the gain test circuits shown. 

Comments invited! rap@galaxy.nsc.com —or: Mail Stop D2597A, National Semiconductor P.O. Box 58090, Santa Clara, CA 95052-8090

BOB PEASE obtained a BSEE from MIT in 1961 and is Staff Scientist at National Semiconductor Corp., Santa Clara, Calif.



What's All This PNP Stuff, Anyhow?

Back in the 1960s, I worked with Joe, a good technician who was very analytical. He told me he had put in many months of study to figure out how to bet on horse races. He analyzed all the handicaps, the horses' records and times, the jockeys' records, and so on, just as bettors have done for years.

After all those months, though, he decided he couldn't compute how he should bet on horses. His system was never really good enough to actually predict which horse would win and make him money. So, he gave up.

Then Joe tried to invent a way to get around the poor PNP transistors of the day. If he could do that, he would be a hero. Even now, many PNPs aren't as good as NPNs. Joe told me that he had put in many hours, over several months, to try to use two good NPNs to replace a mediocre PNP. And, he finally admitted, he couldn't do it. Instead, he was going to try to use three NPNs to replace a PNP.

I thought about his idea. I finally told him that he should go back to playing the horses. It would be a better investment of his time.

HERE'S ONE SOLUTION

But there is a good way to replace a PNP Darlington (Fig. 1a) or a composite PNP/NPN (Fig. 1b) with a trick circuit using one PNP and one NPN (plus a couple of auxiliary 1-mA current sources). We figured it out when we were trying to build some very fast digital-to-analog converters (DACs).

We had a bunch of PNP current sources that were turned on and off. They were working well and fast. The output currents were added together. Yet when all the PNP collectors were bussed together, the output capacitance was getting quite big.

Could we avoid having the response delayed by the poor total capacitance? Maybe we could put in a PNP cascode. But obviously, the cascode's alpha would get poor, quite fast. And, a PNP Darlington would have inferior response. We couldn't get it to settle in the required 80 ns. What's a mother to do?

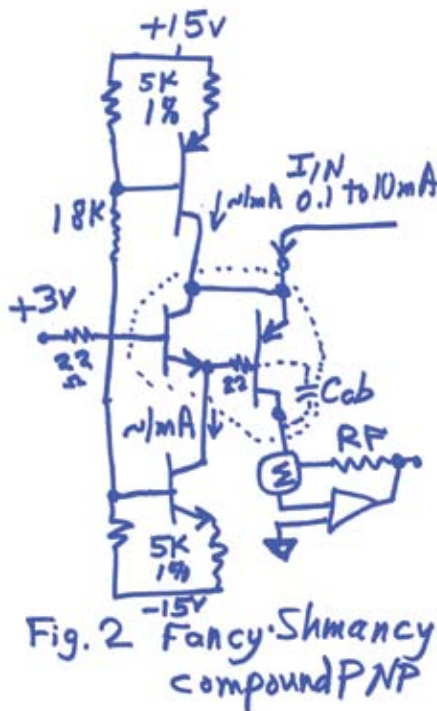
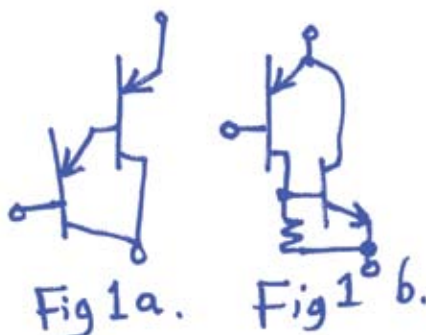

It turns out that this trick circuit has some advantages (Fig. 2). It not only has better alpha than the best single PNP, it also has lower output capacitance and faster F-alpha. These days, PNPs are often good enough so you don't always get in trouble with them. But sometimes, this circuit's advantages are still useful.

ON THE BENCH

The current flowing in Ccb does still flow, but at moderate speeds (slower than 250 V/μs), this current can be ignored! Any current that flows at the collector end is dumped into the base, through the NPN's emitter, and is subtracted from the PNP's emitter current. So, the effective Ccb is decreased by a factor of the NPN's beta.

Likewise, if you dump current into the PNP's emitter and its C_{TE} causes a lot of that current to flow into its base, that current gets cancelled, and the current gain at high frequency is improved, just as the dc alpha is improved. I must admit this sounds much too good to be true, but it does work, and it does tend to settle quickly in the time domain, too.

This improvement applies to the ratty old 2N1131s and 2N1132s (with C_{ob} = 30 pF and beta = 7 to 40) and provides surprisingly good, quick performance. It also applies to faster PNPs such as 2N2907s and 2N3906s, if you need a little boost in

performance. I don't recall if I have ever seen this circuit in print. Joe never figured it out, because he wasn't looking for this approach. But it can be useful, even in the era of modern PNPs and fast ICs. It can even help an NPN! ☺

Comments invited! rap@galaxy.nsc.com —or:
 Mail Stop D2597A, National Semiconductor
 P.O. Box 58090, Santa Clara, CA 95052-8090

BOB PEASE obtained a BSEE from MIT in 1961 and is Staff Scientist at National Semiconductor Corp., Santa Clara, Calif.



Mailbag

H

I BOB,

Thanks for the articles on output impedance. They reminded me of the time back in the early 1970s when I was working as a part-time engineering technician (while going to school) for a company that made professional audio tape recorders.

I had been working part-time in production test until one fateful day when there was some sort of upheaval in the engineering department. The VP of engineering and senior engineer both quit. The junior engineer was promoted to senior engineer, the engineering technician was promoted to junior engineer, and I became the new engineering technician.

For the most part, my job was documentation, etc. However, one day I noticed some sort of commotion regarding a new machine that was soon to be released into production. Apparently, a decision was made that the maximum audio output level previously specified at +16 dBm was not sufficient and the spec was changed to +20 dBm. The new senior and junior engineer were working on the problem and I had plenty of work to do with my ammonia-belching blueprint machine, so I didn't get involved.

I was off for a couple of days and returned to find that they were still trying to solve the output level issue. The two guys really looked the worse for wear. I offered to help. (My sinuses were so burnt from the ammonia, I could see the problem with an open mind.)

Here is what I found: a 24-V power supply powering all op amps; op amps biased at 12 V; a 741-type op amp used as an output stage, ac-coupled driving an audio transformer wired for 600 Ω: 600 Ω; an HP voltmeter/distortion analyzer connected across the secondary of the transformer; and a 600-Ω termination at the input of the normally high-input impedance of the HP voltmeter.

I ran the circuit and verified the +16-dBm output. I then asked what they had tried to get the additional 4 db. They told me that the output transformer could be configured for 150-Ω: 600-Ω operation and that should give them 6 dB more output level, and that is what they have been working on.

So I rewired the transformer for 150:600 and tested the circuit. I confirmed what they saw. They couldn't even get the +16 dBm with this configuration. I asked what they else they had done. They had spent two days trying 20 pieces of the same transformer, convinced that they were defective!

I grabbed a piece of perfboard, a complementary pair of transistors, a couple of diodes, and a few resistors and built a class AB output stage. I broke the feedback around the 741 and placed it around my output stage. I didn't notice that while I was working on the solution, the president of the company had

been taking notice. Within 30 minutes, not only had I solved the problem, but I was able to divorce myself from the blueprint machine.
-MICHAEL SIRKIS

HELLO, MICHAEL:

Funny—and sad. I'm glad someone realized that a 741 can't drive ±37 mA into a 150-Ω load. And that a transformer can't put out more mW than you put into it!
-RAP

HI BOB,

I have seen a resistor as high as 30k in the negative feedback of a unity-gain op-amp follower. Do you have any insight as to why it might be there? (It is often a good idea to put a resistor there to offset a similar R that is the impedance of the signal source at the + input. Many op amps have an I_{B+} that's about the same as the I_{B-} , so the $I \times R$'s tend to cancel. However, it is still a good idea to put a C_F across that $30k = R_F$, such as 3 or 30 or preferably 300 or 1000 or 10,000 pf. The right value to put in requires a little engineering.../rap) I cannot find any articles to suggest this is a good thing. (Oh, yeah, we have done this for many years. I could find you two if I had to. See AN-30, etc., from over 30 years ago. Also AN-3, AN-4, AN-20, and several others./rap) I believe it may cause the op amp to become unstable. Any thoughts would be greatly appreciated. I am stumped.
-GARY DIBLANDA

HI, GARY:

The answer is simple, as above. Sometimes even 300k or 3M of R_F may be a good idea, so the total impedance looking out the + and - inputs is the same. But adding some pf across the R_F is almost always a good idea. It is possible that in some layouts, the printed-circuit board wiring strays add 2 or 3 pf, which is enough. But you ought to engineer this, not just wish for this.
-RAP

DEAR BOB,

What is a Trarlington (*"What's All This Current-Source Stuff, Anyhow?" June 12, 2008, p. 60*)?
-JOHN PILIOUNIS

HELLO, JOHN:

For pity's sake! Just because you can't look it up on Google, it doesn't mean it doesn't exist! A Trarlington is a sort of triple Darlington, a cascade of three transistors.
-RAP

Comments invited! rap@galaxy.nsc.com —or:
 Mail Stop D2597A, National Semiconductor
 P.O. Box 58090, Santa Clara, CA 95052-8090

BOB PEASE obtained a BSEE from MIT in 1961 and is Staff Scientist at National Semiconductor Corp., Santa Clara, Calif.



WHAT'S ALL THIS ANALOG ENGINEERING STUFF, ANYHOW?

DON'T GET DISMAYED BY THE RISE OF DIGITAL TECHNOLOGIES. ANALOG ENGINEERS ARE STILL CRITICAL MEMBERS OF ANY DESIGN TEAM.

For many years, aficionados of digital circuits and computers have bragged that their rapid advances will leave all analog circuits lying in the dust. The analog business is shrinking, at least compared to the success of digital computers. Moore's law has made sure of that for many years. The tiny transistors are smaller and faster than ever, even if they can't stand off 5 V (*Fig. 1*).

The efforts of a team of digital men who engineered and fit together a few hundred transistors has given way to automated schemes to assemble many thousands, many millions, and now billions of transistors. Boy, every circuit must cost millions of bucks! That means every microprocessor or system-on-a-chip (SoC) must be very profitable! Right?

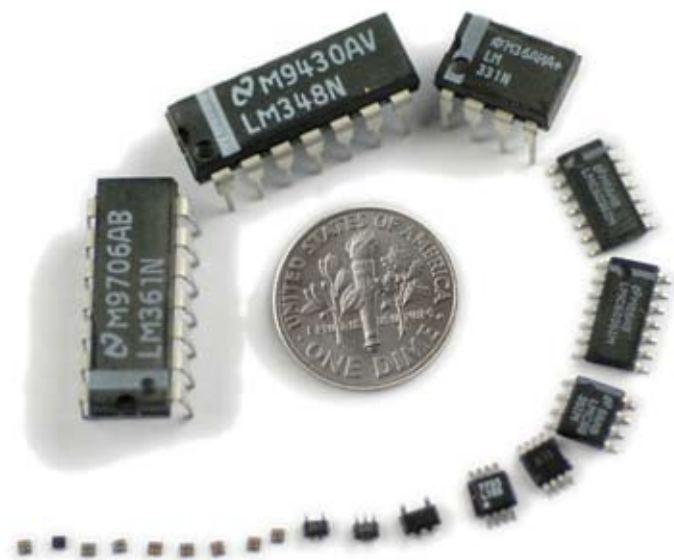

1. The electronics industry has evolved as packages have gotten smaller and smaller. For example, the 14-pin dual-inline package (DIP) is now today's micro-SMD.

Wrong. It ignores the fact that several thousand digital transistors may now sell for less than a penny. Digital IC makers must give away a million transistors to make a few bucks. This isn't necessarily true for analog circuits. A couple dozen years ago, we handed out some license plate frames in Silicon Valley that said "One good op amp is worth 1000 microprocessors." We still believe that!

A digital computer can do some things by computing the facts it is told. But to perform a useful function, it often needs a good bit of analog information. It needs to get information from the world or from its user. It also needs to get this data from sensors, where the information is channeled through analog pre-amps and/or filters. Usually, analog engineers have to engineer these channels. A brute-force approach generally doesn't work.

Some sensors put out a signal that can be acquired directly by a fairly simple analog-to-digital converter (ADC) that interfaces to the sensor. But, typically, a high-performance ADC needs an anti-aliasing filter to prevent the sampling from turning high-frequency noises and spikes into low-frequency "artifacts."

What kind of filter is needed, and how many dB of attenuation are needed at the sampling frequency? The person who designs that filter has to complete the filter engineering in the analog domain. You can't do it with digital signal processing (DSP). You must have a good analog filter before you get the information converted into signals that can be processed by DSP.

Now, in theory, it sounds like an ADC or digital-to-analog converter (DAC) will be designed by one analog group and one digital group that sit down, shake hands across a table, and figure out how to get their circuits to do a handshake, too (*Fig. 2*). But in practice, most high-performance ADCs are designed by analog engineers. They have to figure out how all of the signals and waveforms will get along without causing trouble.

Yes, they do have to handle some digital signals, but that's not too hard. We analog engineers know

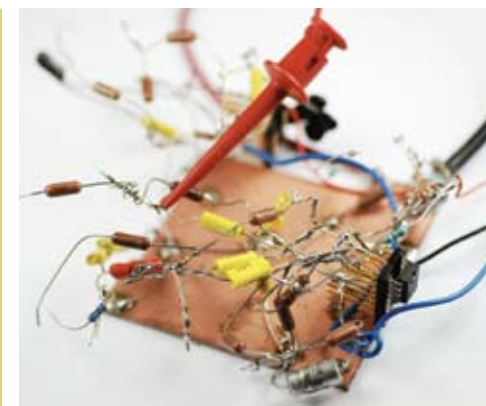

2. It may look like a rat's nest, but this voltage-to-frequency converter was built over a ground plane using an LM331 and a couple of optional sizes of filter capacitor. That's how I usually wire up a breadboard. I never use a solderless breadboard. I built it to confirm that the LM331 still works just as well as it did when I first invented it 31 years ago.

how to handle "digital" signals without excessive bounce or overshoot! We know how to design and lay out transmission lines, terminated as needed.

Sure, some ADCs are integrated onto the main SoC, but these are mostly the low-performance (slow or low-resolution) ones. High-performance ones are usually done off-chip. They are often more cost-effective or time-effective.

Thus, analog circuits are also needed alongside modern microprocessors. Engineers used to try to add a lot of analog functions into the processor. But smaller feature sizes, faster logic, and low operating voltages have forced DIS-integration because a decent audio amplifier, low-noise preamp, bandgap reference, high-resolution ADC, or anti-aliasing filter can't be made (profitably or at all) on such a low-voltage chip.

So, these functions are often being added as external chips. They don't hurt the yield, as they might if they're integrated on the main chip. They don't delay release of a system that is nearly finished. Mindless

A COUPLE DOZEN YEARS AGO, WE HANDED OUT SOME LICENSE PLATE FRAMES THAT SAID “ONE GOOD OP AMP IS WORTH 1000 MICROPROCESSORS.”

WE STILL BELIEVE THAT!

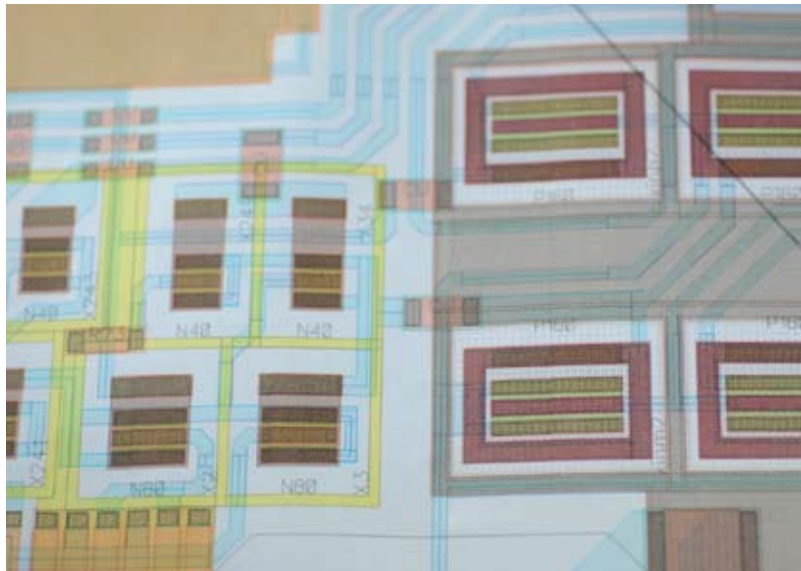

3. Op amps give designers lots of flexibility and can even lead to applications that the op-amp manufacturer never intended.

attempts at further integration have, in many cases, been replaced with disintegration.

There are still applications for digital computers, where most of the work is just computation. When the computing is all done, after a few hours, the computer spits out the answer: “42.” But these days, there’s often a lot of interaction between the user and the computer.

Sensors are needed. And, the sensor needs an ADC to convert the variable (force, position, pressure, temperature) into a digital format so the processor can figure out what to do with that information.

Temperature is one of the parameters that SoCs often try to sense. Sometimes the system wants to know the ambient temperature. Sometimes it also wants to know about the processor’s temperature to help prevent overheating. It isn’t impossible to do this with the temperature computation done on the main chip. However, it’s usually better, cheaper, and easier to do it accurately with an external (disintegrated) temperature-measuring circuit off the main SoC.

This is often done with a remote diode temperature sensor (RDTS), which can sense temperature using almost any kind of stable diode or transistor. It can even sense the temperature of one transistor built into the middle of the main processor and, thus, protect it. Of course, detecting the ambient temp requires

an off-chip sensor. Why not put the temp measuring function off-chip?

VOLTAGE REGULATOR STUFF...

It’s quite true that many CMOS ICs can run on a wide range of power-supply voltages. So, you can get some things done by running them on a small battery. But modern high-performance CMOS circuits run fast on a low-voltage supply. If the battery voltage runs low, the CMOS runs slow, and the timing may suffer. If the battery gets too high, the CMOS starts to break down and overheat. So, modern CMOS circuits need to run with a regulated supply.

Many low-dropout (LDO) regulators can run accurately on low voltages and regulate a battery source down to a lower voltage, but they generally aren’t very efficient. LDOs often waste as much power as they put out. So while they are quite useful in some cases, they won’t let you run your cellular phone for a long time. I mean, which would you buy—a cell phone or computer that runs for three hours or six hours?

That’s why we need switch-mode regulators to get good efficiency. Aha! A switcher has drivers and power MOSFETs that turn on and off—a bang-bang controller. That must be a good digital application!

But not at all. While the nominal voltage levels seem to be ones and zeros, the actual output voltage depends precisely on the time ratio or duty cycle of those apparently “bang-bang” signals. The duty cycle of these signals is an analog function and is controlled by an analog controller. So all computers these days run on regulated power, regulated by analog switch-mode controllers—controllers designed by analog designers.

The only digital things in those controllers are the techniques by which the fast duty-cycle signals are driven. And even these need analog techniques to help them behave and save power. On a good day, analog engineers are wild men about saving power. Sometimes we are very good at it.

Even a digital computer may need analog circuits, such as low-voltage differential signaling (LVDS), to transfer a lot of data from place to place. All you digital engineers now know that you can’t just feed some full-size digital signals at high speed to a different location, like on a backplane, or on flex cabling, at flat-out speed.

You have to engineer (using refined techniques) the signals into small, balanced (push-pull) differential

signals. Then, you have to put the signals on carefully laid-out transmission lines. And, you have to use nice little preamps to recover the signals at the required place. Note that these are analog techniques.

I used to think that LVDS was the dumbest idea in the world. Why would anybody buy *that*? Then, after a long time, I began to realize that if LVDS were so stupid, nobody would buy it. Yet these LVDS drivers, multiplexers, and receivers were selling well, and the business was even expanding. It was I who was kind of dumb.

People wouldn’t buy them if they weren’t useful, cost-effective, and valuable, even if I was too stupid and slow to see the value. After all, it was my old colleague Jay Last, one of the original Fairchild Eight, who observed, “The only valid market survey is a signed purchase order.” A lot of analog circuits are sold that way. The customer knows what the ICs are useful for, even if the maker does not.

An operational amplifier is called that because it can perform just about any operation according to what feedback components you put around it. The beauty of the op amp is exactly what things the customer can (and does) think to do with an amplifier, or a regulator, that we never thought of or told him how to do (*Fig. 3*).

New applications are invented every day! Often, the customer does that inventing. Sometimes he tells us what he’s doing or asks if it’s okay. But usually he is too busy to tell us, and sometimes he really doesn’t want to tell anybody.

Analog drivers are also needed for backplane drivers and display drivers in computer displays. Getting a lot of info up there needs careful analog planning, not just a lot of wires. There are still a lot of applications that depend on layout to get a circuit to work well. And, many parts of a good layout depend on analog engineering.

Some wireless techniques rely on a lot of digital codes. That’s very true. But to pick these codes out of the air, the preamps need analog techniques, with good RF preamps. They need mixers and AVC circuits to avoid overloading. I’m not a very good RF engineer, but I know that the art of RF engineering isn’t simple. If a digital engineer can do it, that is all very good, but then we should properly call him an RF engineer.

WHAT’S NEXT?

Are we analog engineers worried about the analog business dying out? I don’t think so. Every year, we

Expand.



Many of the world's leading electronic products have one thing in common: they are built with **ROHM components**. We have contributed our expertise to major brand names in computer, consumer, communication, and automotive electronics. Our secret is looking forward to next generation semiconductor technologies. Composite devices, nano bionics, photonics, solid state lighting, SiC power devices and advanced compound semiconductors are among our current projects. We support our customers with a powerful manufacturing network that spans the entire globe. In fact, ROHM is the world's largest component-only manufacturer.

To expand your performance and experience a faster time to market with higher quality for your applications, get to know ROHM.



Excellence in Electronics

ROHM

To find out more about ROHM products: www.rohmelectronics.com | 1.888.775.ROHM

PEASE PORRIDGE

are confronted with more work and problems than we can do in a year and a half or two years. Most of it is profitable. A lot of it is fun! If I weren't having fun, I would go away and do something else.

I've never been tempted to do that. The analog business is almost always challenging. Our work often involves challenges where computers or simulation cannot help us. But experimenting often can. And thinking often can.

In the last year, some of my buddies showed me some excellent audio amplifiers with nonlinearity down near or below 1 ppm. I studied around and measured, and I found these amplifiers were actually 10 times better than the engineers thought they were, using advanced analog measurement and analysis techniques. (Refer to AN-1671 at www.national.com/an/AN/AN-1671.pdf). I also cheated by bringing in various resistor and series R-C networks. There are still things you can do with Rs and Cs that are fun ways to solve problems, and they are not obvious!

If you're an analog engineer, don't jump off any bridges because somebody tells you that Moore's law will put you out of business. (In actuality, I have indications and proofs showing that Moore's law is the one in trouble.) Stick together with your analog buddies and keep solving tough problems. I think you will be rewarded. We're going to keep on having a lot of fun— analog circuit fun.

Comments invited! rap@galaxy.nsc.com —or:
Mail Stop D2597A, National Semiconductor
P.O. Box 58090, Santa Clara, CA 95052-8090

BOB PEASE obtained a BSEE from MIT in 1961 and is Staff Scientist at National Semiconductor Corp., Santa Clara, Calif.



What's All This Space Heater Stuff, Anyhow?

I keep hearing people say that the cost of energy is forcing them to choose between paying for gas to get to work, or buying food, or heating the house, or paying the mortgage... So they scrimp as much as they can and then lose their house to foreclosure. That's very unfortunate. I can't tell you how to save money on groceries, but other people will tell you how to do that.

I can't tell you all the ways to burn less gas in your car, but it is possible to slow down and get better gas mileage. By slowing down from 68 mph to about 60, I have improved my gas mileage from 29.6 mpg to about 33.2. That saves me about \$7 a week at present prices. Note: I do not recommend over-inflating your tires, as that can be very dangerous.

But I do slow down and turn off my engine when approaching a red light and coast up slowly. When the light turns green, I can pop my clutch and start up without even having to use the starter. Turning off the engine may be illegal and can get you a ticket, but going broke can be more expensive. If you drive very carefully, turning off the engine at traffic lights, as the hybrids do, can be very helpful. Take advantage of downhills. Shift into neutral if you can do that without any harm to the car.

KEEPING WARM

But there are some principles of engineering that can help you save money heating your house. Ideally, it would be nice if we could keep our entire house at a nice warm temperature. But this gets expensive in cold weather, as we have noticed. My first few suggestions are pretty obvious and well documented.

Close off rooms you don't use. If there's a room that isn't easy to close off, add clear plastic as a drape at its entrance to keep the heat where you want it. Turn your thermostat down to 64°F or cooler. Put on a sweater—or two. Wear long underwear and even gloves or mittens. Finally, get an extra blanket or a sleeping bag so you can turn the thermostat way down at night.

Now, no matter what you do to save energy, don't let your pipes freeze. In some parts of the country, that's a serious problem. Sometimes in the coldest weather, letting a remote faucet drip can prevent frozen pipes. The dripping faucet can be somebody else's problem.

When I was a starving student, I didn't have all the choices listed above. But if I tried to keep my apartment warm in the winter, I would not have enough money for beer. We considered that a serious problem. So we figured out how to keep the minimum amount of space warm.

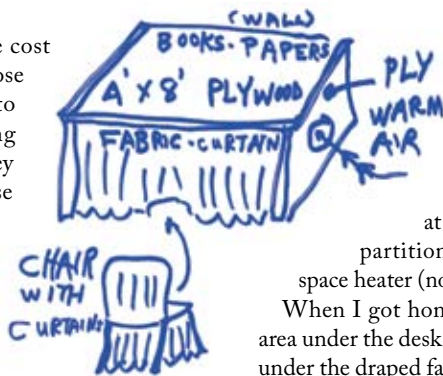

I had a nice 4-by-8 plywood table or desk. When the fuel bills got too high, I draped some fabric around the edge of the table, almost like a tent, and I sat at the table a lot when reading, doing homework, etc. Then at one end of the table, I set up a plywood partition, with a hole cut in it for a 1000-W space heater (no fabric near there).

When I got home and fired up that space heater, the area under the desk warmed up very quickly. I set my chair under the draped fabric, so the heat could escape only past my elbows (*see the figure*). This was quite cozy. Even the bottom of the chair got blocked by more fabric. My ankles and legs and tummy were quite toasty, even as the rest of the house was allowed to run cold. I wore a sweater and a bathrobe.

Our pet lab rat "Baby" was very agreeable. When he came by, he was so impressed, he would climb inside the bathrobe and peek out the sleeves by my wrist. He seemed to agree it was a very cozy, warm area.

This might not work for everybody, but shrinking the area and volume you try to heat is a really good way to conserve money and energy. I didn't try to put my lamp under the desk and shine its light up by mirrors. I didn't try to recover the heat from the coils in the back of the refrigerator. (With the kitchen running so cool, the refrigerator didn't run very much.) I didn't rig a really good thermostat.

Yet this arrangement did help a lot. Further, rigging a small space heater is much easier than rigging an air conditioner to blow on your knees because it doesn't have to have a vent to the outside, as an air conditioner would.

When I moved into my house in Wilmington, Mass., in 1963, I burned about \$600 of heating oil per season. It was about 18 cents per gallon. When I moved out in 1976, I still burned about \$600 of oil—at about 90 cents per gallon.

Of course, I had gotten a wood stove and burned lots of nearby firewood and newspapers and junk mail. I never really bought any firewood. I just chopped up unwanted logs, boards, etc. If a wood stove would fit into my house in San Francisco, I could just burn my 60 lb per week of junk mail and cut my heating costs a lot. ☺

Comments invited! rap@galaxy.nsc.com —or:
Mail Stop D2597A, National Semiconductor
P.O. Box 58090, Santa Clara, CA 95052-8090

BOB PEASE obtained a BSEE from MIT in 1961 and is Staff Scientist at National Semiconductor Corp., Santa Clara, Calif.



mailbag

BOB,
 You said, "I don't recall if I've ever seen this circuit in print" (*What's All This PNP Stuff, Anyhow?* Sept. 11, 2008, p. 80; www.electronicdesign.com, *ED Online 19605*), regarding Figure 2. See:

1. P.J. Baxandall, E.W. Swallow, "Constant Current Source With Unusually High Internal Resistance And Good Temperature Stability," *Electronic Letters*, Sept. 1966, Vol. 2, No. 9, p. 351-352.

2. Thomas M. Frederiksen, "A Monolithic High-Power Series Voltage Regulator," *IEEE Journal of Solid-State Circuits*, Dec. 1968, Vol. 7, #12, p. 380-387. **-WALT JUNG**

HI BOB,

You said, "I don't recall if I've ever seen this circuit in print." I came up with the dash-circled NPN-PNP combination during a coffee bet with Tom Frederiksen when he was at Motorola. You might ask Tom when exactly that was, but it had to be the early 1960s. It's in the MC1494 (multiplier with level shift). It's also written up in several ICE (Integrated Circuit Engineering, Glen Madland/Howard Dicken) tutorials that I wrote during the 1960s. **-JAMES E. THOMPSON, PE**

HELLO, JIM:

I might have seen some of the ICEs, but it does not ring a bell if I first saw the circuit there. Even if I did re-invent it independently, which I doubt, I sure doubt I did it first. Hey, why didn't you patent it? Why was Motorola so foolish? Thanks for explaining where it came from. I'm glad to see you get the credit. I'm also going to mail your e-mail to Tom. I was just on the phone with him. He does have some recollections of the days when this circuit was invented. As I mentioned to Walt Jung, I don't recall where I saw this circuit. I didn't really think I invented it independently. But on the other hand, I didn't see either of those magazines Walt mentioned. And I don't think it has been in print very often since 1968. **-RAP**

HI BOB,

A couple of decades ago, I was experimenting with some complementary JFET circuits, including the lambda diode configuration. I was amazed. Here was a configuration that allowed me to construct a sine-wave oscillator using only four components (two JFETs, a capacitor, and an inductor). I was able to construct a very simple 455-kHz BFO for my home-built short-wave receiver when the exigencies of family and career took precedence. Since then, I've had no real need to return to researching this device. So I was wondering if there were any modern-day applications for the lambda diode or if

this device is now just as much a laboratory curiosity as a standard tunnel diode or tetrode valve. **-MARK BARNER**

HI, MARK,

Tetrodes are consistent and reproducible. FETs have such a wide range of V_P and ID_{SS} that if you made a good circuit with some FETs, you would never be sure you could make a good circuit again! I'd much rather design with tetrodes. I can't think of anything I would design with JFETs. It is true that monolithic op amps made with adjacent (well matched) FETs can be pretty good. Almost nobody designs with tunnel diodes anymore. Almost nobody makes them. They, too, are far out and not easy to characterize. Hard to select for the characteristics you might want. Almost anything you could make with FETs or lambda diodes, I could make better with bipolars. Or an op amp. I do like JFETs for analog switches. **-RAP**

BOB,

I haven't seen you comment on either the DTV transition or HD radio. We keep hearing about how DTV will make us happier because it's "better." But I don't see the video or audio being noticeably better than a good analog signal. And now we're hearing from the Wilmington, Va., test that DTV doesn't work at all in the fringe areas (as expected). DTV even with a converter box won't let me program my VCR to record more than one channel. And it won't work with my portable TV. HD radio has been available for several years, but I still don't hear much talk about it. Analog FM with a good signal is quite good enough for me. Why do I need FM HD, unless I want the extra channels that a few stations might offer? FM HD has such low power that it has much less range. AM HD is useless. At least in Chicago, there is hardly any music on AM. So why do I need better fidelity for news and talk? In fact, AM HD has degraded analog AM. It wipes out the adjacent channels and raises the on-channel noise floor. Very annoying. The radio stations don't promote it much, and I don't know anyone who has an HD radio. **-KENNETH LUNDGREN**

HI, KEN:

I'm not an RF man. Like many "digital" things, it sounds like the hype and the reality are far apart. What's new? **-RAP**

Comments invited! rap@galaxy.nsc.com —or:
 Mail Stop D2597A, National Semiconductor
 P.O. Box 58090, Santa Clara, CA 95052-8090

BOB PEASE obtained a BSEE from MIT in 1961 and is Staff Scientist at National Semiconductor Corp., Santa Clara, Calif.



What's All This Floobydust Stuff, Anyhow? (Part 5B)

People keep asking me when they will get to see my latest Dead Car List, where I keep track of all the disabled and abandoned cars I see on the road. Alas, while I have a couple of grocery bags of raw data on dead cars, I have not been able to find time or priority to organize them into a list. I've been too busy for 15 years, writing columns and other technical stuff.

Here's the real problem. Cars now just about all look the same. It used to be that I could tell the difference between a Ford, Chevy, VW, Saab, or Peugeot from three or four lanes away, even at night, even in the rain. That was 30 years ago.

These days, the boxes mostly look the same. The jellybeans look about the same. The SUVs look about the same. The nameplate on the trunk lid is usually unreadable at 60 mph. Also, cars are not as unreliable as they used to be. So, any data is not gonna be significant. Sigh. I'll still keep any data I get, but it's not as significant as it used to be.

TAXY

Several years ago, one of my correspondents told me (repeatedly) that a certain amount of taxable income plus some Social Security income would take you to a place where every dollar you earned would cause 85 cents of income tax. This is not done in any tax table, but in the Social Security Benefits Worksheet. I published this statement back in the April 10, 2007 issue (*"What's All This AMT Stuff, Anyhow?"* www.electronicdesign.com, *ED Online 18511*).

Several readers were very skeptical. So, I asked my correspondent at exactly what incomes this 85% rate would happen. My correspondent denied ever telling me what he had told me four times. So I must, sadly, retract my statement of the "85% tax rate." I apologize for my error. Apocryphal. Meanwhile, I have never taken any Social Security income. If I'm lucky, I never will.

NEW BOOK

I recently finished editing a book, *Analog Circuits—World Class Design*. You can look it up on the Barnes & Noble Web site at www.bn.com or on Amazon.com. It has 18 excellent chapters by eight very good authors. Take a peek.

CHRISTMAS TREE LIGHTS

Howard Frank told me about his tool for fixing dead Christmas tree lights, per "What's All This 'Others Stay Lighted' Stuff, Anyhow?" (*March 1, 2007, ED Online 14867*) It's called the Lightkeeper Pro, and it can be found at LightkeeperPro.com. It has two good tools for finding the dead bulb and fixing it up.



The Web site lists many good hardware stores that can sell you one. If you have just a dozen strings of those cheap series-wired lights, you might get along without it. But if you have 40 or 140 or 400 strings, as some people do, and they are getting old and flakey, you would definitely want this tool.

ANOTHER ERROR TO FIX

One of my sharp readers, Martin Fischer from Deutschland, questioned my numbers in my old "What's All This V_{BE} stuff, Anyhow? (Part 1)" column from June 26, 2000. The article isn't available on the *Electronic Design* Web site, but it is posted on my Web site at www.national.com/rap/Story/vbe.html.

Martin thought I had bad numbers for the mV per decade, and he was correct. I'd said it was 60 mV per decade at 27°, and it is really 59.5264. I was off by +0.8%. My general analysis and approach was pretty good, but I was using the wrong numbers.

For a quick and dirty approximation, 60 mV per decade at room temperature is a pretty good rough rule of thumb, with 80 mV when hot at 127°C and 40 mV at -73°C. But the accurate value of kT/q at 300 Kelvin is 25.582 mV, as the value of Boltzmann's Constant is quite precisely known, as is the charge of the electron. And it's 59.5264 mV per decade, not 60.

So, I'll have to rework that text and the drawings. I'm sorry! Thanks for hollering, Martin! He was the first reader to catch that error. ☹

Comments invited! rap@galaxy.nsc.com —or:
Mail Stop D2597A, National Semiconductor
P.O. Box 58090, Santa Clara, CA 95052-8090

BOB PEASE obtained a BSEE from MIT in 1961 and is Staff Scientist at National Semiconductor Corp., Santa Clara, Calif.



mailbag

B

OB,

I've once again bumped into the limit of an op amp. A single op amp can provide gain or level shifting but not both at once. (I tend to disagree. A single op amp can do a lot of things. It can pat its tummy and rub its head and hop up and down on one foot and provide gain *and* offset. /rap)

I'm feeling around for a way to do a circuit. Depending on what is happening at the time, one end or the other of the resistor may be at the amplifier's negative supply. (Okay, the op amp or op amps should run on a single supply, using no negative supply. /rap)

I've got a dc current that can vary ± 10 A, and I want to be able to read down to about 10 mA. I can give up quite a bit of high current accuracy, but hope to see into the mud at low currents. The op amps will be supplied with a ground that will be equal to the most negative end of the sense resistor.

If I pick an op amp that includes ground in its common mode, I could use the attached circuit—Figure A—and depending on which direction the current was flowing in, I would digitize the appropriate signal. (Beware. What ADC do you want to use? /

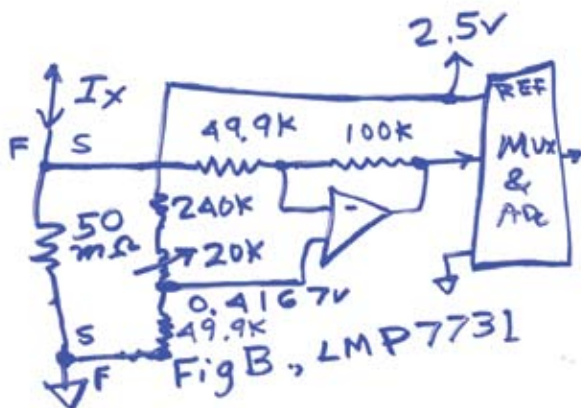
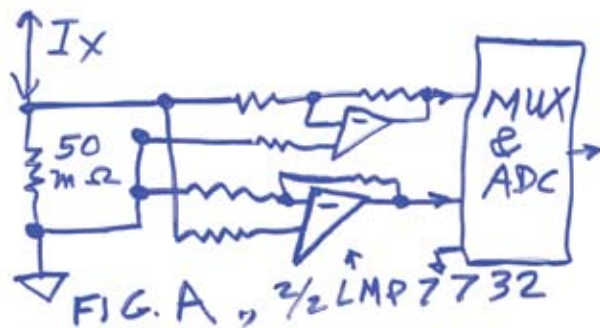

rap) I can play around with the value of the sense resistor a bit, but I want to keep the $I \times R$ drop below around half a volt. This means that at 10 mA, I will have only 0.5 mV of signal that will be very close to the op-amp ground.

(It sounds like you need an ADC with more than 12 bits of resolution to read 0.5 mV out of +500 mV to -500 mV as full scale. Many of these exist, but the ADC does not always go down to 0.0 mV, and most op amps do not go down to 0.0 mV. But I know how to make this work.

If you have 5 A flowing, the sense R might get to +250 mV, and you'd want to resolve 0.5 mV with perhaps 0.1-mV resolution. If you have -5 A flowing, the sense R might get -250 mV, and you would still want to resolve small changes such as 1 or 0.5 mV, with 0.1-mV resolution. If you were at +5 A, you would want to know if a change was -10 mA or if it was +10 mA, right? If you were at 0 A, and 0.000 A, you would still like to be able to resolve a +10-mA change or a -10-mA change, right? /rap)

I've considered using a chopper stabilized op amp, but don't like the cost. I wonder if today's op amps might have improved input offsets that would let me digitize to 10 or 12 bits and see the first count reliably. (You seem torn between using 10 or 12 bits, whereas I think you might be dissatisfied with anything less than 14 bits. What power supply do you have? Is it +5 V or +12 V or what? Is it stable and low-noise? /rap)

A second way of doing this circuit would be an instrumentation amp that at equal inputs would output $ref/2$ and the center would not be related to the common-mode voltage. I may end up rolling my own out of a quad package. (Even good op amps don't automatically make good instrumentation amplifiers. It sounds like, in this case, you need an offset, so when there is 0 mA of P.S. drain, the ADC will get an input that is in the center of its range (Fig. B). What V_{REF} does the ADC get? 2.5 V? What kind of ADC do you want? What have you decided on? /rap)

So I'm bouncing between doing an instrumentation amp versus the drawing I attached. I could calibrate the instrumentation amp for zero, but calibration costs money and I will be annoyed with dealing with drift.

-KARL SCHMIDT

HELLO, KARL:

These days, good op amps do not drift much. You could look up the LMP7731 or 7732.

-RAP

Comments invited! rap@galaxy.nsc.com —or:
 Mail Stop D2597A, National Semiconductor
 P.O. Box 58090, Santa Clara, CA 95052-8090

BOB PEASE obtained a BSEE from MIT in 1961 and is Staff Scientist at National Semiconductor Corp., Santa Clara, Calif.

pease porridge
BOB PEASE CONTRIBUTING EDITOR
 rap@galaxy.nsc.com



What's All This "Adjustable Slewing Rate" Stuff, Anyhow?

The other day, a guy wrote in requesting help. "How can I make an amplifier with adjustable positive and negative slewing rates?" he asked. I instantly replied, "Easily," and I drew this up. As soon as I got to work, I scanned and sent him the basic circuit (Fig. 1).

You turn the P1 pot until the available current through R1 is adequate to give the desired maximum negative slewing rate. Likewise, turn P2 so the i through R2 is what you want for a good positive slewing rate. We rarely see this circuit anywhere. If I had to find where it is in print, I probably couldn't. Yet I made a couple in the last two years from memory. So, it is time to publish this good basic circuit.

Just choose Cf so $70 \mu\text{A} = i = V_s/R1 = C \text{ dV/dt}$ is as fast as you need for your fastest slewing rate. Then you can slow down the slewing rate by a factor of ~20 or 30:1 with the pot. For faster or slower speeds, use other values for Cf.

But if you absent-mindedly used 10k for R1 and R2, you would find that if P1 is set far differently than P2, the output would shift a lot in dc offset. That's why 200k is better than 10k. If you went to 1M, that would work okay. Yet even if you used a FET input op amp, that might be drift-y or noisy.

COOKING UP AN ADDITION

That's when I cooked up the ADD-ON circuit (inside dashed lines). I was going to connect point x to an inverting amplifier and feed some current to point y. This would have worked well, to compensate for any current imbalance in R1, R2, so the dc output voltage would not shift much.

However, I remembered a good circuit I cooked up 40 years ago in Fort Wayne, Ind. A customer was using a photoresistor to vary an amplifier's gain, as in Figure 2. But when the Rf went up to 5M, the amplifier became much too slow, due to the 5-pF capacitance inherent in the photoresistor. What to do?

At first I was going to use an extra op amp to make a negative capacitor to cancel out the Cf. But then I figured out it might work well if I just connected an adjustable C' back to the positive input. We tried it and it worked fine! It cancelled out the Cf under all conditions and extended the BW by 10 \times .

So I put in the compensation by linking point x to point z, and that worked well, too! The output offset stays within a couple dozen mV of ground, even as the pot voltages change from 1 to 14 V. Not perfect, but good.

THE RIGHT SAFETY FACTOR

I've heard arguments that every audio amplifier should have a 7:1 or 10:1 safety factor between its actual slewing rate and the biggest, fastest signal it will have to handle. I used this circuit to show that a 3:1 margin would probably not cause 0.01% distortion in that signal. I was all set to give the demo, when I discovered that nobody wanted to listen to the demo. They had made up their minds and didn't want to listen!

Anyhow, a factor of 1.5:1 or 2:1 is probably not safe, but 3 should be plenty. Don't waste a lot of money on ultra-fast amplifiers to get a safety factor of 7 or 10. Also, don't worry too much about slewing-rate symmetry. If an amplifier is fast enough in one direction, and faster in the other direction, that's not a big deal. I mean, who the heck spends a lot of time LISTENING TO SQUARE WAVES?! (Don't answer that question...)

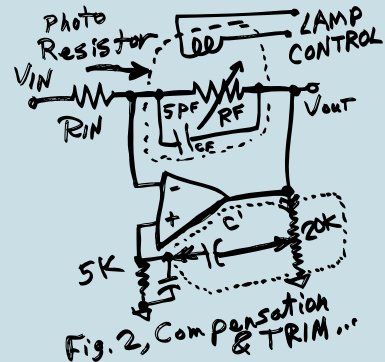
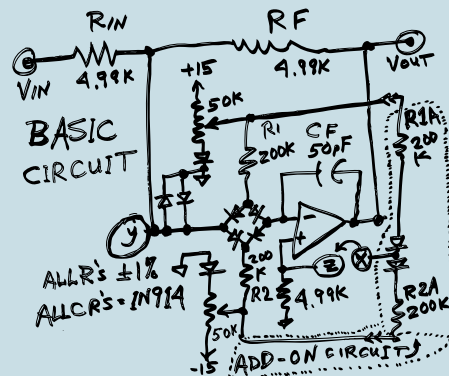

(If you wanted to be sure to get matched positive and negative slewing rates, you could throw out P2 and use an op amp to invert the voltage at the wiper of P1 to put the same magnitude of voltage at the foot of R2.)

As I said last year ("What's All This 'Best Trick Circuit' Stuff, Anyhow?" Dec. 3, 2007, ED Online 17601), Lenny Kleinrock taught me to look at all the "breakpoints" so I would know what happens in each "piece-wise linear region" of my circuit. You'll see some more in a short while. Hey, I just bought a couple hundred low-leakage diodes! ☺

Comments invited! rap@galaxy.nsc.com —or:
 Mail Stop D2597A, National Semiconductor
 P.O. Box 58090, Santa Clara, CA 95052-8090

BOB PEASE obtained a BSEE from MIT in 1961 and is Staff Scientist at National Semiconductor Corp., Santa Clara, Calif.



mailbag

B

OB,

I read your article “What’s All This Analog Engineering Stuff, Anyway?” (*Oct. 2, p. 18, ED Online 19754*) I totally agree that the need for trained analog engineers is not going away. (I am not so interested in training, but in education. /rap)

I have been in analog engineering since my BSEE in 1958 from that other school in Pasadena, and I can still analyze a circuit using the math tools I got in school. (I don’t use “PSPICE” or any other kind of hired computer analysis. I use “Pease SPICE,” which is “back of envelope SPICE.” I use analog insights to analyze how the response will be. /rap)

The problem is, when I interview candidates for an engineering position, I find that many cannot even draw the output waveform on a simple RC differentiator driven by a step function. If I ask them if they know how to use the Laplace transform, they say they haven’t looked at it since school.

(Actually, I don’t think anybody ever tried to teach me Laplace transform stuff. But I do know how to close a loop. Did you see my BOBB, Ball On Beam Balancer? Hey, a ball on a beam is a double integrator. Most people don’t know how to close a loop around that. /rap)

A frightening majority of the candidates I see are now relying on the computer and simulation software to do their designs. The trend is worrisome.
—BRUCE WILKINSON

HELLO, BRUCE:

There are many trends that are worrisome. We have to encourage the smart kids that do know how to solve problems and comprehend and analyze circuits. We don’t need a lot of well-trained engineers, just a few well-educated guys. —RAP

HI, MR. PEASE,

I read your book *Troubleshooting Analog Circuits*, and something popped up in my mind. On page 101-102, you wrote about manipulating noise gain to get stability. You put the resistor from negative input to ground or to positive input. The result was noise gain increasing to 6x, but signal gain is still 1x. I’m interested in noise gain, say, the whole system is already stable. (The system may be stable. But if the noise gain is increased a lot, the output can get slow and/or noisy. /rap) In your examples, the noise gain is always greater than signal gain. (That is often true. But, no, for a unity gain follower, the NG can be equal to the signal gain. Or for an amplifier with positive gain, such as +1, +2, +10, or +100, the NG can be equal to or greater than the signal gain. It does not have to be greater than... /rap) Is there an op-amp input/feedback resistor configuration that can give noise gain that’s less than signal gain?
—DAVID

HI DAVID,

Normally, the answer is no. If you make a logger using a transistor with a grounded base, with the op amp’s output coupled in to the emitter, and the collector goes to the summing point, the transistor can add gain to the loop. The noise gain can stay low, while the gain gets higher. But that happens only because the transistor is adding extra gain. Sort of cheating. So unless you are making a log function, NG is normally equal to or higher than the signal gain—and can be a lot higher.
—RAP

HI BOB,

We have a battery-powered LED driver circuit that will be part of a disposable medical device. The logical question came up about whether leakage through the transistor switch would drain the battery in two years of product shelf life. If I can believe it, PSPICE shows an off-state leakage of 39 nA, not much at all (Most transistors, when OFF, leak less than 39 pA. But PSPICE is a poor choice to trust. /rap), and if true with the actual circuit, two-year shelf life would be a piece of cake.

Figuring that the real world has lots of potential leakage paths on a printed-circuit board (PCB), I thought it best to make an actual measurement. (Any good PCB will also leak less than 39 pA. /rap) The equipment at hand is a Fluke 8846A, which touts nanoampere measurement capability. (It will take me a while to find the 8846A. Why not put 1 μF of mylar across the inputs of the Fluke? /rap)

All’s great, except for one issue: noise. Even after zeroing the meter, it’s hard to tell if I am really measuring anything but noise on the 100-μA FS range. (If you really want to read leakage current, use the 1-M or 10-M input in the voltage mode. You can resolve 100 pA × 1 M = 100 μV. You could put 0.1 μF across that to cut the noise down. /rap)

We thought about putting the circuit in a Faraday cage but haven’t done that yet. Do you have a suggestion on making this measurement?
—ART ZIKORUS

HI, ART,

Put it in a cake pan. A metal cake pan. Put aluminum foil over the top. If you only have a glass cake pan, put tinfoil over the top and the bottom. Ground the tin foil. Any good DVM will be able to resolve sub-nano-ampere currents.
—RAP

Comments invited! rap@galaxy.nsc.com —or:
Mail Stop D2597A, National Semiconductor
P.O. Box 58090, Santa Clara, CA 95052-8090

BOB PEASE obtained a BSEE from MIT in 1961 and is Staff Scientist at National Semiconductor Corp., Santa Clara, Calif.

BOB PEASE | Contributing Editor
rap@galaxy.nsc.com



What's All This Raging Canal Stuff, Anyhow?



There's an old folk song that goes, "Well, she's gone, gone, gone, and she's gone, gone, gone. I lost my true love on the Raging Canal." Back in the 1840s, a bunch of local Connecticut businessmen decided, after seeing how well the 1825 Erie Canal was going, that a canal could enable commerce between Hartford and the upper Connecticut River.

Steamboats could get around the rapids at Enfield, using this canal, which would also provide water for businesses along the 5-mile route. The businessmen ran this canal for many years. Of course, 150 years later, the canal was in some disrepair. I looked into this and decided I would like to canoe down it.

SIGN? WHAT SIGN? • My sister said that there seemed to be a sign saying "Boating Prohibited." But I have never seen this sign. I know that many bicyclists are unable to read. If a sign says "Bikes Keep Out," the riders cannot read it. On they proceed.

Well, if I went to that canal at midnight, I could not read or see such a sign, either. Too dark? Maybe we could ease into the canal at 11 p.m. and get to the far end and out before anybody noticed. We did some research and reconnoitering. After all, in the 1970s, the canoeing guidebooks plainly said, "Take the Canal and avoid the dam and rapids at Enfield."

In the central part of Connecticut, where I grew up, we had *lots* of mills, and originally they ran by water power. So there were little canals fetching the water from a high pond to the waterwheels at the mills. Knitting mills, spinning mills, weaving, and even envelope-making mills.

As we learned in the third grade, the "fall line" was where the streams had a large dropoff and were able to generate a LOT of water power. Even when steam or electricity replaced water power, many mills needed a large flow of water for certain kinds of washing and processing. The water downstream from the mill often smelled quite soapy or oily.

So mills were a major feature of most towns. If there wasn't a mill, there wasn't a town—the economics of the 1800s. The Windsor Locks Canal did not have a LOT of flow, or a LOT of dropoff, but it was a fairly reliable water supply.

INFILTRATION AND EXFILTRATION • There's no easy road access to the canal, so we would have to kayak down the river to get to the old canal guard locks (inlet locks). By the light of the full moon? Maybe when the moon has nearly set... to avoid alerting the militia. Muffled oars, and all that.

We did enough scouting to pinpoint the trees that had fallen across the canal and indicate where we might have to wade over silt bars. This handsome old canal had nearly vertical stone or concrete banks, so we would need rope ladders to get up and down the walls. We brought

rope ladders and grappling hooks. Life vests were de rigueur.

But where were we going to take the canoe back out of the canal? If we got to the foot of the canal, a steep slide would get us back to the Connecticut—and we could take out on the opposite east bank. Not such a bad deal, in weak moonlight. September

is a time of low flow, so the currents would not be nasty or dangerous. I would hate to be pushy. We were not pushy.

I did not "lose my true love" on the "Raging Canal." A canal like this is substantially flat-water. Not boring in terms of 160 years of history, nor in terms of challenges. Just flat.

FINANCIAL FLOOBYDUST • Switching gears, Alan Greenspan has admitted that he screwed up and had a bad model for the economy. He claims he misunderstood what was going to happen. What did Spice suggest for him to do? I coulda told you that Greenspan was not doing a good job on his PID controller.

He waited too long to start decreasing the interest rates, and then he decreased them too slowly. I noticed that at the time! Then, by leaving the interest rate at 1% for too long, he got the ARMs to start out too low. And then when the rates went up, the subprime mortgage holders got whip-sawed.

This is exactly how you make a limit-cycle oscillator! In other words, Mr. Greenspan did not have enough D (derivative) term in his controller, and he failed to anticipate new problems. And he had too much gain in the I (integral) path. I can do this any day, on my bench, but I don't destroy a nation's economy.

No, I don't want to take over Greenspan's job. I don't want that job. But I could still do it less badly. ☺



Comments invited! rap@galaxy.nsc.com —or:
Mail Stop D2597A, National Semiconductor
P.O. Box 58090, Santa Clara, CA 95052-8090

BOB PEASE obtained a BSEE from MIT in 1961 and is Staff Scientist at National Semiconductor Corp., Santa Clara, Calif.

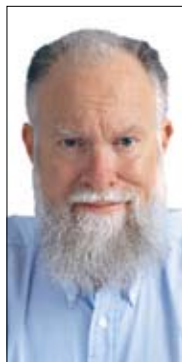

Mailbox



HELLO TO MR. BOB PEASE!

In the datasheet for the LM135/LM235/LM335, there is no mention of capacitive bypass (minimum acceptable, maximum acceptable). This publication also did not say anything: www.national.com/appinfo/tempensors/files/tempnb2.pdf.

(I apologize for this omission. You are right. This info should have been included. However, the LM135 came out about 1975, when you were probably in the sixth grade. Are you smarter now than when you were in the sixth grade? Don't answer that question... /rap)

If I mount the sensor at the very end of a long coaxial cable, I have 30 pF per foot, and my gut-feel is high risk of parasitic oscillation. The complex impedance at the end of a coaxial line is a Smith Chart. If I include only the last 20 feet, I have 600 pF, which is exactly the type of value that often causes instability.

(There are four main solutions to your problem. First, try it, as is, with just the 600-pF load (A). Second, try it with 0.1 μ F added (B). Third, try it with 0.1 μ F in series added with a 100- Ω pot and see which setting of the pot gives the best results (C). Of course, when I say "try it," I mean don't just see if it oscillates.

If you are feeding about 1 mA into the LM135, take a 10k resistor in series with 0.1 μ F and put an additional 0.1 mA + and - of square wave into the terminal of the LM135. See how the output rings or bounces. If it damps out with a Q of 1 or 2 or less, you are probably okay. It is entirely possible that cases A or B will be just fine. But it is likely that case C will be better. Let me know which R works best.

Now take your best result and cool off the LM135 to a slightly colder temp than you expect it to see. Also, heat it a little warmer than you expect it to see. An ice cube and a solder iron may work just fine (D). /rap)

I would prefer to include 0.1- μ F capacitive bypass so that the impedance is well-defined. Is it okay? Isn't it a big deficiency to not have any discussion about acceptable capacitor bypass in the datasheet?

(I suspect not really, as the LM135 is probably safe. I haven't gotten a question on this in the last 16 years, so it may be okay. But you are wise to inquire.

I'm not going to add this to the LM135 datasheet, but I will post this info nearby in my BEST 1982 data book, which is my master correction file. That way, if somebody asks me in 16 years when I am 84 years old, I'll have the data at my fingertips.

Why won't I put this into the datasheet? Because I would have to look at all temperatures, and at all bias currents between 1 and 10 mA, and at all capacitors between 22 pF and 22 μ F. I cannot possibly justify looking at all these places, whereas you can easily reassure yourself for the places you care about in less than four minutes! /rap)

No discussion of acceptable impedance values seen by the two-terminal device LM335? It should be in the datasheet so I don't have to ask the factory.

NORM HILL

HI NORM,

Like I said above, you are safe; 0.1 μ F + 22 Ω is fine.

RAP

SIR,

There is so much talk about analog engineering and all the demand for analog engineers. Why is it such a difficult area,

or is it all just hype around it?

GANESH

HELLO GANESH,

Of course there is a lot of talk about analog engineering, and for good reason. There are many things about analog circuits, techniques, and measurements that are not taught in schools. See my recent article on all this analog stuff (*Oct. 2, 2008, p. 18*; www.electronicdesign.com, *ED Online 19754*).

Or read one of Jim Williams' books about the art of analog design. If your school doesn't have it, the library should buy it. The art of understanding someone else's circuit is one problem. The art of inventing one is something else again. His first book is a bit better... And read my book on troubleshooting analog circuits. Good stuff. If your school doesn't have it, the library should buy it.

In addition, there are more problems with thermals. Spice almost never handles thermals well. Most analog circuits can be laid out well—or badly. Thermal interactions are one thing. Matching is another. Cross-talk of capacitive strays is another. And that's not all.

After you have read a lot, ask me some more questions. Those of us who have been designing linear circuits for more than 50 years know it isn't just hype. It is an art. What kinds of schools teach art? World-class art?

Best wishes.

RAP

Comments invited! rap@galaxy.nsc.com —or:

Mail Stop D2597A, National Semiconductor
P.O. Box 58090, Santa Clara, CA 95052-8090

BOB PEASE obtained a BSEE from MIT in 1961 and is Staff Scientist at National Semiconductor Corp., Santa Clara, Calif.



What's All This Time-Domain Stuff, Anyhow?

Last night, I was attacking a thorny problem and thought about the time domain. I think about circuits, as an engineer, in the time domain. When something happens, or changes, then something else can happen—or may start to happen. Is that something that I like? Or is it something I don't like?

I have used this analysis many times, as in "What's All This Fuzzy-Logic Stuff, Anyhow? (Part 4)" (Nov. 6, 2000; www.electronicdesign.com, *ED Online 4915*) and "What's All This Ball-On-Beam Balancer Stuff, Anyhow?" (Nov. 20, 1995, *ED Online 6126*).

I know some engineers who like to work in the time domain and some guys who like to work in the frequency domain. We have different kinds of heads. We may each be able to solve a problem, but from completely different angles. Different strategies. And sometimes we have to collaborate. That can be fun! I mean, I am not completely ignorant of the F domain, but I rarely find it helpful.

I know a lot of good engineers who work primarily in the time domain. Often we can solve some problems that the frequency-domain guys have trouble with, such as the ball-on-beam balancer (BOBB) and the fuzzy controller for steam boilers. I get insights that the fuzzy-logic guys and the F-domain guys don't.

KEY QUESTIONS

Several years ago, a guy asked me, "When an LM308 has its dc gain increase, don't you get in trouble when its ac gain increases proportionately?" I asked him where he got that notion from. He said he read it in a book. I told him to drag out that book and X out that idea.

I explained that the gain-bandwidth of any modern op amp (designed in the last 40 years) is invariant of the dc gain. He said his simulations did not show that. I told him his simulations and models were just wrong. The book was wrong.

Then I asked him if he ran a simulation of an LM108 with high gain (–500,000), another one with low gain (–50,000), and another one with reversed gain (+500,000), what if the simulation told him some of them would not work well? What if he ran the amplifiers and they all worked well (as I am sure they would)? Which would he believe, the simulation or the silicon?

He did not know how to answer my questions. He went away. He never came back. I hope he believed the real amplifiers. A few weeks ago, I bumped into another guy who still believed that:

$$A_V = A_{V0} \times 1/(1 + s \times F_0)$$

where F_0 is the purported "low-frequency rolloff" frequency. Even at Philbrick, we used to say that. Even when we were wrong. Even when we should have known better. For him, I cooked up a better expression. For mid-frequencies, it is fair to say:

$$-V_O = 2\pi f_H \int V_{IN} dt$$

which is the same as saying:

$$-V_{IN} = p \times V_{OUT}/2\pi f_H$$

where f_H is the gain-bandwidth product or the unity-gain frequency. Or if you want to add a second high-frequency rolloff near f_H , that's easy. But for the low-frequency rolloff, the correct way to look at it is:

$$-V_O = 2\pi f_H \int V_{IN} dt \times \frac{(p \times f A_{V0} / 2\pi f_H)}{(1 + (p \times f A_{V0} / 2\pi f_H))}$$

The default value of gain when f gets very small becomes $A_V = \sim A_{V0}$, as the other terms cancel out. But the low-frequency "break frequency" moves around as A_{V0} changes. It's $F_0 = 2\pi f_H/A_{V0}$, and that's okay.

The frequency domain guys can analyze this any way they want to. The fuzzy-logic guys can analyze it any way they want to. But I have a bunch of friends who have sold several *billion* op amps, and we are *right*, and most frequency-domain guys are *wrong*, about how to describe an op amp.

If the dc gain goes up to 10 million, or more, that's not really bad. The f-3dB could fall to 0.1 Hz, or lower, but that does not mean that the amplifier's response will have long settling tails at 0.1 Hz—as I pointed out in "What's All This Output Impedance Stuff, Anyhow? (Part 2)" (Aug. 28, 2008; *ED Online 19555*).

Am I any expert on poles and zeros? Uh-uh. The frequency-domain guys have those tools. They like to use those to solve some problems that I would probably have trouble with. I prefer to solve those problems in the time domain. I like to use $p = d/dt$. The derivative operator. In linear systems, in the frequency domain, $p = s = 2\pi j(f)$, but I won't waste much time with that. How can I sell you on the time domain? Where can you learn more? I dunno. More later. ☺

Comments invited! rap@galaxy.nsc.com —or:
Mail Stop D2597A, National Semiconductor
P.O. Box 58090, Santa Clara, CA 95052-8090

BOB PEASE obtained a BSEE from MIT in 1961 and is Staff Scientist at National Semiconductor Corp., Santa Clara, Calif.



Mailbox



HI BOB,

We know that the noise power generated in a resistor is proportional to temperature. If we have a resistor with a zero thermal coefficient so that the resistance is constant with the temperature, does the temperature of the resistor increase due to the thermal noise? (No, not even sub-infinitesimally! /rap) In other words, does the resistor noise create noise voltage or current in the resistor, which in turn heats the resistor to a higher temperature, which in turn increases the noise, which in turn heats the resistor to a higher temperature, etc.?

(If you have a 1-M resistor with a BW of 1 MHz, $V = 125 \mu\text{V}$, and $I = 125 \text{ pA}$, its self-heating would be about 15 fW. In a 250-mW resistor, with nominal heatsinking, this would cause a temperature rise of 60 femto degrees. I don't think we have to worry, even if it did do self-heating! If you have a different R value, the dissipation in femtowatts will be about the same, even if the BW does get bigger. /rap)

My guess is that the noise power calculated by $P = 4 \times k \times T \times \text{BW}$ assumes an infinite heatsink maintained at temperature T. Without an infinite heatsink, then, there will be some increase in temperature, albeit small, depending on the thermal resistance. With a practical value of thermal resistance, the temperature would no doubt only increment by a minute amount. However, theoretically, if the thermal resistance between the resistor and the heatsink was very large, the resistor temperature could increase until the resistor burns out.

(Fat chance! If the temperature rose from 25°C to 125°C or 225°C, the resistor would radiate its watts away—no heat-sinking required. /rap)

I figured I would get your insight before I calculated the temperature increase by some limit method or, perish the thought, simulation. This might generate an interesting problem in which one would cal-

culate the thermal resistance at which the resistor power would dissipate a specific amount of power

On the other hand, it would seem that if you sealed the resistor in a vacuum with a thermal resistance approaching infinity, the resistor could get pretty hot, perhaps 10 picodegrees of temperature rise! The heat power would have to go somewhere or the temperature would reach infinity, so we should be able to harvest some of the heat and use it to do work. But, no, this is not going to cause the world to come to an end. The positive feedback will not send it off to a crazy temperature, which leads me to think there is something wrong with my theory. (I gotta admit, I can't tell you exactly what is wrong with your theory, but something is! /rap) Have you ever thought about this?

STEVE STECKLER

HI STEVE,

I have tried as hard as possible to avoid thinking about it! I'm going to go home and pour a drink—or two. I'll let you know if I learn anything.

RAP

DEAR BOB,

What is your opinion about biasing the phototransistor base input to change the response of a phototransistor to light? I am trying to maximize the transistor's sensitivity to light (digital on-off), but I also think it may be possible to use the base input to increase the speed in which the phototransistor turns off. I do not think I can do both easily.

KEVIN STRATTON

HELLO KEVIN,

If you pull down on the base of the phototransistor, that helps it turn off—for example, from the base (pin 6) of a 4N28. But that will make it much less sensitive to the first little bit of photocurrent. It won't be sensitive to small photocurrents—maybe not at all.

You may be able to feed the phototransistor's output to a linear amplifier and then to a nonlinear amplifier. But I think you are right that there is no simple way to do both of the things that you wish for. Maybe you can buy a higher gain of phototransistor, but they are often slower—slower to turn on, and slower to turn off.

Write down exactly what you want each little bit (increment) of current to do. But it sounds as if you want a linear amplifier with high gain, plus the advantages of high digital gain (fast on/off). It is usually hard to do both! Best wishes.

RAP

HI BOB,

I'm working on a home project and need a programmable (waveshape) ac source (50 to 300 V, up to 10 A). Since it is for home, I need a cost-effective way to obtain one. Any suggestions?

LANCE AKAGI

HI LANCE,

Audio power amplifiers that can put out 1500 W aren't cheap. Put two of them push-pull (bridge output) into a big transformer, which also isn't cheap, because you can find audio amplifiers that would put out 100 V at 30 A (as into 4 Ω) but not 300 V into 10 A. $V \times I$ is not interchangeable, unless you can find a suitable transformer.

You want 300 V RMS? That's a BIG power transformer. Get a dozen 300-W audio amplifiers. Put each output into a mid-sized transformer to give 30 V × 10 A on the secondary. Stack 10 of those transformer secondaries. Stand back!

RAP

Comments invited! rap@galaxy.nsc.com
—or:

Mail Stop D2597A, National Semiconductor
P.O. Box 58090, Santa Clara, CA 95052-8090

BOB PEASE obtained a BSEE from MIT in 1961 and is Staff Scientist at National Semiconductor Corp., Santa Clara, Calif.

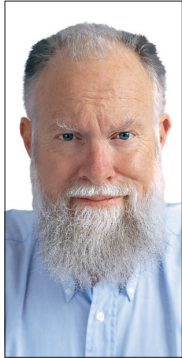

What's All This Rock-Hopping Stuff, Anyhow?

I went on a hike last weekend. Some of the trail was uphill, some was downhill, and I hiked along fine (if slowly). That's not a surprise. But when I had to hop across a tiny stream, I had problems. When I had to hop across a second stream, there was more of the same. I could not hop or leap or jump, not worth a darn. Not leaping, not landing.

I got across the rill, but got my shoes and feet damp. So I am aware that my excellent rock-hopping days are mostly gone by. I may practice to do a little better, but now I am a bum. My ankles are in poor shape, and my leaping muscles are weak and shot because I have done so little vigorous hiking in the last 24 months.

HIT THE TRAILS

If you want a list of excellent rock-hopping places, I will be happy to recommend some, like the Fowler River north (and east) of Cardigan Lodge in New Hampshire. There are many others. Search 'em out.

If you go up to the northeast of Nepal, near Mt. Kangchenjunga, walk a half mile to the west from Kanbuchan, eight miles north of Ghunsa. You will find a million rocks arranged nicely so you can rock-hop for at least an hour and never step on two rocks at the same time. Never even step on the earth. I did that, two hours in a row. When I had to leave to go to supper, there were still many rocks enticing me.

Now I would love to go back to these places, but I could not appreciate them as I used to. So, I just have to recommend to you, to carry on the art. It requires a great appreciation of balance, and a great amount of calibration of force and strength, for leaping nicely.

My old friend Dan Buckley and I hiked down the Fowler River, near Cardigan Lodge, several years ago (well, 40 years). We hiked down one bank, or the other, or the middle, or back and forth across the stream. For over an hour we never get our feet damp. We were *good*, and the flow of the river was just right for us to do that leaping.

Dan and I followed each other, turn on turn. It was a great challenge, and we had a lot of fun. If the river is too high, or too low, things might look a lot different. New rocks may be available. Always changing.

I hiked down from five miles above Gurjakani in central Nepal, near Dhaulagiri. Any rock that was wet was terribly, dangerously slithery-slippery. Don't go rock-hopping in a place like that unless the rock

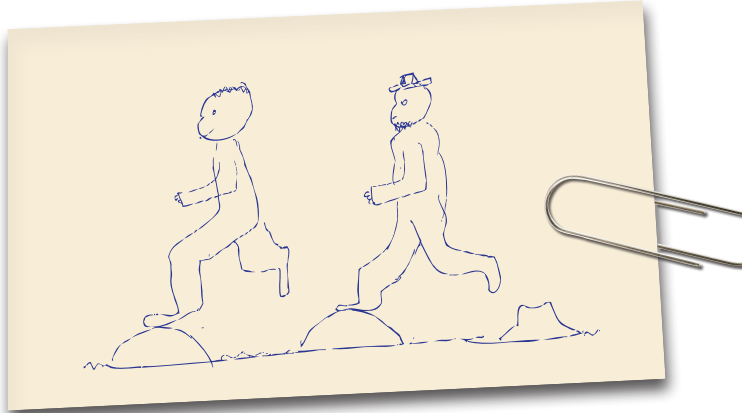

is dry. I never saw such slippery rock. Some organic substances apparently made it greasy.

One time in 2004, I was hiking down from Langtang Village, toward Lama Hotel. As the trail crossed a small stream, I stepped on a pretty round rock, and it rolled grossly, sending me badly out of balance. I hopped straight up in the air. When I came down, I was still slightly out of balance, so I jumped up again. I came down flat and square and stopped.

I went back and picked up that rock and chucked it downhill about 40 yards, like a shotput. It will never fool or roll anybody again. Jai Rai was my witness. I don't think I could do that again.

Can you have more fun than rock-hopping (with your clothes on)? Maybe.

DOWN THE RAGING CANAL

A number of readers asked me for details about my trip down the Windsor Locks Canal (*see "What's All This Raging Canal Stuff, Anyhow?" Jan. 15, 2009, p. 72; www.electronicdesign.com, ED Online 20410*). I had to explain to them that I actually did not float down that canal. It was too cold. It also was too easy to get nabbed, pulled into court, and forced to make an extra (expensive) trip east.

I never did say that we really went there. I did not lie. I just described our planning. If you want to sneak down to the Windsor Locks Canal, you are welcome to borrow my plans. Best of luck! Please let me know how it goes. ☺

Comments invited! rap@galaxy.nsc.com —or:
Mail Stop D2597A, National Semiconductor
P.O. Box 58090, Santa Clara, CA 95052-8090

BOB PEASE obtained a BSEE from MIT in 1961 and is Staff Scientist at National Semiconductor Corp., Santa Clara, Calif.

March 18, 2009

Bob Pease Is Leaving National, But Not Electronic Design



March 18, 2009 12:00 AM
Electronic Design
Richard Gawel

The rumors are true. National Semiconductor's sweeping layoff plans include Bob Pease. But that doesn't mean he's leaving. He is one of the inaugural members of our Engineering Hall of Fame and the most popular columnist on our staff. We will continue to present his latest musings—whether they're on the best way to get more power out of your next design, responding to questions from readers, or recalling his latest adventure in far-off lands. We consider it a privilege and an honor to carry his byline. His e-mail address may change, but rest assured that Bob will still get the "last word" in every issue of .

In fact, we want to hear from you if you're a fan of Bob's wit and wisdom. Is his column the first page you turn to in every issue? Would you like to see more of his work online, through blogs or even video? Maybe you'd like to see him in person at some road shows. Leave us a note through the commenting box below or send us an e-mail. Analog engineering isn't dead, not by a long shot. Just take a look at Bob's column from last fall—"What's All This Analog Engineering Stuff, Anyhow?" And we're committed to bringing you the best ideas that the industry—and Bob—have to offer.

Bob's Most Recent Columns

[What's All This Rock-Hopping Stuff, Anyhow?](#)

[Bob's Mailbox](#)

[What's All This Time-Domain Stuff, Anyhow?](#)

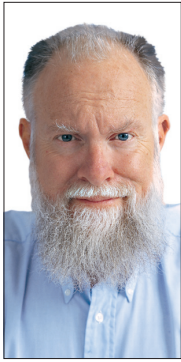

Mailbox



DEAR MR. PEASE,

The “Financial Floobydust” section of your latest piece is, I think, anything but floobydust (*Jan. 15, p. 72; ED Online 20410*). I believe you have touched upon a fundamental weakness at the core of so much financial and macroeconomic modeling, black-box investing, and other quantitative aspects of high finance.

As you know, financial practitioners use models of all stripes to express expectations for future trends, from the price of cocoa beans to interest-rate levels. Clearly, the industry’s track record with respect to modeling such expectations has been abysmal for the last decade. And we do not appear to be getting any better at it.

I believe that financial practitioners must reassess some of our most basic forecasting practices, from the assumptions that go into our models to the techniques we have for generating output. I especially think that practitioners are too trigonometry-impaired (having not once, that I can recall, seen a wave function to forecast cyclicity or to project a detrended data series in the 10 years that I have worked as an analyst in capital markets).

In short, I think financial analysts have a lot more to learn from electrical engineers—with their practical, hands-on modeling skills—than from the theoretical physicists and pure “quants” behind every discredited financial model from long-term capital management to the CDS securitizations. The industry is looking in the wrong place, for the wrong kind of math—and finding it, to the repeated detriment of the global economic system.

I am nearing completion of a book entitled *Fringe Statistics: The Hunt for Crisis-Proof Financial Models*. The goal is to describe, in a way that financial practitioners can understand, how best to “import” certain time-tested, disciplined quantitative techniques broadly used in other fields to

the field of finance (as well as to resuscitate certain techniques once at use in my field, but which have fallen by the wayside).

Unfortunately, I don’t know any electrical engineers with whom I could “kick the tires” on this subject. And I believe it is critical that I get input from true scientists. I respect your viewpoint and would very much appreciate the opportunity to speak with you by phone. (Informally and “off the record” is fine. I am not a journalist, just a budding author.) **TROY PEERY**

HELLO, TROY PEERY,

Yeah, we agree on many things. Let’s talk. I’ll give you a call one of these mornings. But I would be very cautious about your phrase “Crisis-Proof Financial Models.” I would tend to say “Crisis-Resistant...” On the other hand, the models we have seen recently were pretty disastrous, weren’t they? Best wishes. **RAP**

HI MR. PEASE,

I work with piezoelectrics, so the topic of boost converters is always of interest, particularly getting 3 to 12 V dc (That 4:1 range is brutal! If we could do it from 6 to 12 V, would that be okay? /rap) up to 150 V dc or so, at up to 10-W power levels. (Yeah, all you want is 70 mA out for 4 A input. /rap) With high efficiency. In zero space. I seem to be hampered by two things.

First, published suggestions for operating conditions, and standard formulas that work fine for most LV converters, yield poor efficiency and/or smoke when applied to HV boost converters. Ringing between inductor and diode can be excessive, and my low- R_{DS} HV MOSFETs have huge gate capacitances that prevent me from working at the frequencies necessary to use reasonably sized components. I’m not even sure my inductors are good at the frequencies where I want to use them. My customer has a saying, “fight for every

millimeter,” and displays more than a little terror when confronted with an inductor that’s larger than an 0805 resistor.

(I may be able to sell you a “Camel Amplifier.” That is a circuit, no one part of which is so hard, but the total system becomes impossible. /rap)

Second, we want off-the-shelf parts, and there never seems to be enough information about commercial inductors to calculate a design. It always ends up being trial and error in the form of “Install a smaller part. If it burns up, go one size larger.” Shades of Muntz TV. So, do you have any advice for designing HV converters? Ideally, a list of pitfalls unique to HV boost circuits and how to address them. Is an 85% to 95% efficiency converter even possible in the boost configuration? **CONRAD HOFFMAN**

HELLO CONRAD,

With all your conditions? Probably not. That is *beastly* hard. I’ll ask around. You want it to be SC-proof on the output, too? My move. **RAP**

PEASE TO AMARILLO

I got a letter from a guy named Michael asking for help on a high-Z problem. But he didn’t include his address, his e-mail address, his phone or fax number, or even his last name. If the postal service hadn’t stamped “Amarillo” as the postmark, I wouldn’t even know how to identify him at all. So, Michael, you’ll have to give me more info before I can help you.

Comments invited! rap@galaxy.nsc.com
—or:

Mail Stop D2597A, National Semiconductor
P.O. Box 58090, Santa Clara, CA 95052-8090

BOB PEASE obtained a BSEE from MIT in 1961 and is Staff Scientist at National Semiconductor Corp., Santa Clara, Calif.

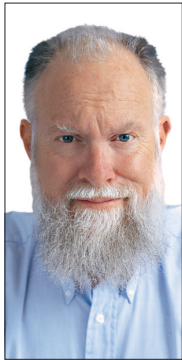

What's All This "Free Amplifier" Stuff, Anyhow?

One of my friends was working on a story. She observed correctly that an "ideal" op amp would have infinite gain and common-mode rejection ratio (CMRR)—and zero I_B and V_{OS} —and zero price. She conceded she would never get rich selling those op amps!

But there is a zero-price op amp, and I have been using them for many years—over 40. Maybe you have too. Let's assume I have used three-fourths of an LM324 for three tasks, and that is working fine. Suddenly a need arises for *one more amplifier*. Hey, I could solve that problem by using the unused channel of that LM324. Will it work well? The signals aren't very tiny or fast.

PRICE VERSUS COST

We know that the price is "free," but the cost probably isn't "zero." Connecting the "unused" channel may require other signals to be pushed around or aside, with the accompanying costs of new layout—and cross-talk—and delay. And what if the new amplifier doesn't work well?

So, we have found, we want to be skeptical. Asking an LM324 to do a low-pass filter on a 20-Hz signal can cause distortion of a mere -31 dB... if you don't know how to do it.

I mean, I hate to say it, but NSC's macromodels for an LM324-type amplifier do not show their inherent output distortion. I've tried to fix this... without much luck. Would you like me to show you how to model an LM324? See the figure. Even if you're talking about an unused chunk of a higher-performance

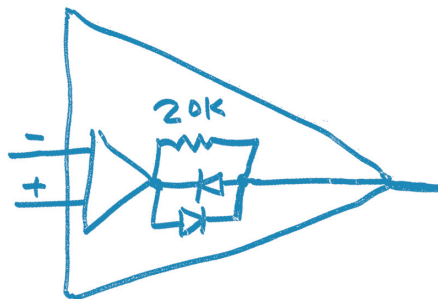

Most LM324 macro-models don't include the inherent output nonlinearity. Make a new model, as shown, with about two diodes added, and this makes a reasonable model. To defeat this non-linearity, add a pull-down resistor to the negative supply, making the output run Class A, for small signals.

Let's assume I've used three-fourths of an LM324 for three tasks, and it's working fine. Suddenly a need arises for one more amplifier. I could solve that by using the unused channel of that LM324. Will it work well?

amplifier, fancier and more linear than an LM324, then it may still cause problems. Beware of cross-talk.

Also, beware of poor layout. Myself, I never like to use quad op amps. I prefer to use dual op amps to get better layouts. It's true that two duals usually aren't priced as low as a quadruple amplifier, but design engineers have to use their own judgment on that.

SO MANY CHOICES

NSC does sell several kinds of single op amps that are smaller than one-fourth of an SO-14. You may be able to add in one such amplifier, with less grief than applying one-fourth of an LM324. There are fast ones, low-power ones, and low-noise amplifiers in SOT23-5 and SC70 packages, or even smaller, such as a Micro SMD.

How about using one-fourth of an LM339 comparator as a "free" comparator? Comparators can provide even more trouble because the faster-moving outputs can couple as cross-talk. You have to be very careful in your engineering and layout. Even though the outputs of an LM339 are at the far end of the SO-14 from the inputs, you aren't safe.

How about using one-fourth of an LM324 as a comparator? I've seen people do that, but it's not as simple as it looks. Even with good hysteresis, it's slow and a pain.

I would generally recommend against that, unless your system can tolerate a slow rise time and some chance of the amplifier amplifying its own noise, as the signal passes the threshold. Hysteresis usually won't protect an amplifier from that.

Conversely, adding a couple R's and C's to one-fourth of an LM339 to make a slow amplifier is risky. I've seen it done, but it should not be done as a general deal. Small-package amplifiers will help you avoid more trouble.

Life ain't simple. It never was. ☹

Comments invited! czar44@me.com —or:

R.A. Pease, 682 Miramar Avenue
San Francisco, CA 94112-1232

BOB PEASE obtained a BSEE from MIT in 1961 and has been a Staff Scientist at National Semiconductor Corp., Santa Clara, Calif.

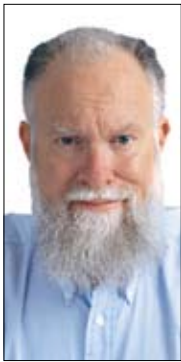

Mailbox



BOB,

I've got 35 years as an electronics design engineer doing microprocessors, hardware, and quite a bit of analog. In the late 1970s, I was involved with two different slew-rate-limited applications.

One was control of the throttle and pitch of the props on patrol boats. The bridge could signal full ahead, and this condition would cause engine stalls. So, a slew-rate control was needed to bring the engine to full power and adjust the prop at the same time in the maximum rate that the engine could respond. *(Good planning. /rap)*

The other was back in the days when memory was expensive. I did a vector-drawn graphical display on a magnetic deflected CRT. A DAC08 was used to control the slew rates by setting the currents to the ring diodes. The system was to draw fonts at different sizes. *(I did some of this too, when I was at Philbrick, designing digital-to-analog converters (DACs) for Loral in New York. /rap)* A pair of 12-bit DACs set the character-start position. (The slew rate controlled movement. We used the core-sense amp for determining when slewing was done.) *(I was designing 12-bit, low-glitch, fast-settling DACs for the major positions at ~6 MHz and 10-bit MDACs for drawing vectors. /rap)*

A font-generation system had DAC control of the font size, six points to 128 points, with DAC control of font width and slew-rate control for angled vectors in the fonts. It all was done in analog, one feeding the next, and it worked like a champ. I loved those DAC08s and the slew-rate control. We needed fixed and stable supplies because of the way that I designed the system. I do not remember the part number but used a National laser-trimmed 10-V reference IC. *(That was surely the LM168, which I got working. Some other poor turkey designed it, but I got it working and into production. /rap)*

There were no pots or adjustments. With op-amp common-driven National three-terminal regulators, we got ± 15 V to better than 10 mV with no adjustments, a stable temperature, and nothing that the customer could adjust to tweak the circuit out of spec. Now that's doing analog. **JIM P.**

HELLO, JIM,

Sounds good to me. I was on a Navy patrol boat off southern California. I looked at the wake, and it would veer and veer. I asked what the problem was, and the steersman said there was a lot of slack in the rudder linkages. I asked him, "Why don't you just set one throttle a little bit slower, and the other one faster, and push against the rudder?" I don't recall him taking my advice. But good engineers have to be smart and devious. **RAP**

DEAR MR. PEASE,

I have a very simple question. We are in the process of designing a printed-circuit board (PCB) containing mixed analog and digital circuitry. The analog circuitry consists of balanced passive (RLC) filters. Would it make sense to remove ground planes under the filter sections to ensure there are no parasitic capacitive effects that could cause unbalance *(I suspect that the ground planes will do more good than harm. I made a Heathkit FM receiver, and it was laid out carefully to reject 10.7-MHz noises and strays. But, it didn't have any digital stuff on the same board. /rap)* and convert common-mode signals to differential? *(I'm guessing that differential is a better way, but I am not an expert on this. /rap)* The frequency range of operation is up to 28 MHz. **ARTHUR WILLIAMS**

HI ARTHUR,

This is up near the extreme end of my expertise. I am just guessing up there. I am very suspicious and skeptical of the con-

cept of putting both these circuits on the same board. Do you want something cheap and cost-effective but doesn't work? Or do you want it to work okay? Do you want it to work on the fifth try, or the second?

I suspect you would want to build the two circuits quite separately. If you're lucky, putting the analog section in a separate shielded box will make it work okay. If you're slightly unlucky, you'll have to also shield the digital section in its own box. You would want to use your best layout engineer to get this. (I could be wrong.)

If you think you are fantastically lucky, you can later merge these two circuit boards into one board. And be prepared to mount copper fences and walls and screens between the analog and digital sections. How much guarding and shielding will you need?

"Are you feeling lucky, punk?" Working in places like that, I don't feel very lucky. I could get each little PCB working, separately, 4 in. apart, but when moved close together, they can't be made to work. There might be some engineers who would have confidence doing this, but not me.

What if your analog section has to have 35 dB of rejection of the digital noises? I suspect you have a chance. But if it's 50 dB, it will probably take all those extreme efforts, and I still have no idea what can go wrong. I'm not an expert on L's and C's in passive filters.

And if you think I'd want to do some consulting on this problem, wrong! What I have just told you is going to be miraculous if you can get it to work. **RAP**

Comments invited! czar44@me.com —or: R.A. Pease, 682 Miramar Avenue San Francisco, CA 94112-1232

BOB PEASE obtained a BSEE from MIT in 1961 and was a Staff Scientist at National Semiconductor Corp., Santa Clara, Calif.

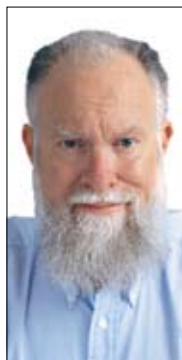

What's All This Counting Stuff, Anyhow?

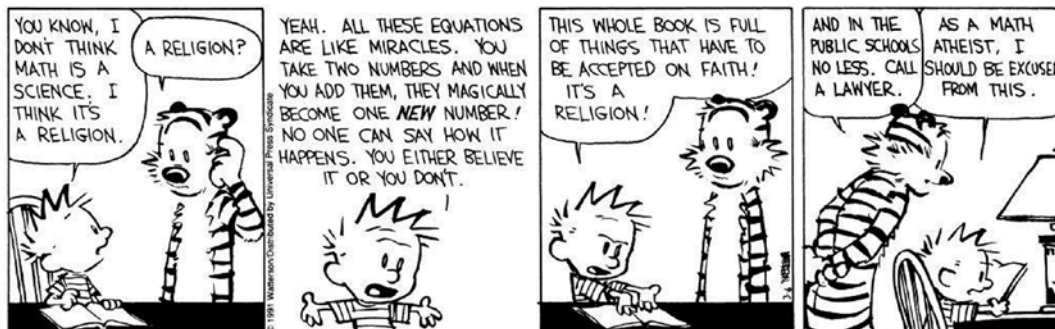

Calvin and Hobbes © 1991 Watterson. Reprinted by permission of Universal Press Syndicate. All rights reserved.

Once upon a time when I was about four years old, my father went up the road to buy a couple of piglets, and he took me along. We brought them home to our little farm in a burlap bag in the back of our pickup truck.

I guess I must have thought this was quite exciting, because my mother thought I was overstimulated. She sent me in to the living room to take a nap, even though it was only 11 a.m. So, I lay quietly on the couch and tried to get to sleep.

But after a half hour, I went in to see my mother in the kitchen. I asked her: "What comes after 999?" She explained, 1000. Okay. Since those days I have done a lot of counting.

I counted the number of three-cent stamps it would take to cover a square light-year. I counted the curves on Page Mill Road (206) and on Mt. Hamilton Road (430 up to the top) and on the back road from Weaver-ville through Hayfork to Cummings (2206 with an old VW bus without power steering).

I count a lot of things. Belches. Dead cars. As Lord Kelvin observed, if you don't measure something, you don't know scientifically what you have. The same goes for counting.

COUNTING ON THE BENCH

I have seen some circuits that failed to work right because we failed to measure and count correctly the number of squares in a resistor—or a gate size. I have also seen some circuits that worked beautifully because we counted the squares wrong, but the wrong number was actually just right! And when my friends play cribbage, I comment, as they are pegging up, "You guys count funny..."

My son recently mailed me an old *Calvin and Hobbes* cartoon (see the figure). Well, Calvin was right! Math is like magic. But it is useful magic, and it's simple enough for little kids to learn. And it's not just illogical.

We discussed that $4 = 1 + 1 + 1 + 1 = 1 + 3 = 3 + 1 = 2 + 2$. That's a good definition of 4, as well as 3 and 2 and 1. It is a useful definition, and a lot of our math depends on a bunch of simple definitions like this.

Counting is, for sure, a lot easier in those Arabic numerals than in Roman numerals. I'd hate to do long division or multiplication with Roman numerals, or even subtraction!

I also count switchbacks on trails. The ascent from Yosemite's floor to the top of the Falls takes 162 switchbacks, whereas if you go up by Mirror Lake, there's only 106. And I counted the stone steps on the Annapurna Circuit, on the trail from Tatopaani on the great Khali Gandaki River up over the pass at Ghorapaani and down to Birethanti.

There are 8515 stone steps up and 9220 down. The stones are nicely set and are called "Gurung Staircases." Pretty good trail! Good hard work with about 6000 feet of rise and fall.

Of course, while you're counting, you usually need to be in good practice to keep counting and not be distracted by other things, like conversation. Don't forget to start counting again at the right place.

Also, you'll want to have some "markers" to help you keep your place. You wouldn't want to forget if you were at 360 or 340 or 460. I often use NSC part numbers as a marker. "The LM360 is a fast comparator." That I can remember.

So counting is a very valuable function and we tend to take it for granted, except when a little kid asks provoking questions. Never a dull moment! ☺

Comments invited! czar44@me.com —or:
R.A. Pease, 682 Miramar Avenue
San Francisco, CA 94112-1232

BOB PEASE obtained a BSEE from MIT in 1961 and was a Staff Scientist at National Semiconductor Corp., Santa Clara, Calif.

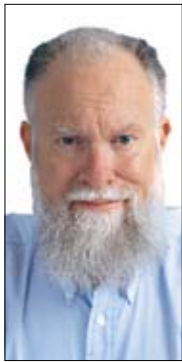

Mailbox



HI BOB,

Regarding quad op amps (“What’s All This *PNP Stuff, Anyhow?*” Sept. 11, 2008; *ED Online 19605*). The current sources for sink and source are about 1 mA, while the current that is to be reflected into the output is 0.1 mA to 10 mA. Any mismatch in the sink, and source currents are going to show up in the output. (Yeah, but these currents are going to match well. That’s why I defined those current reflectors. /rap)

At that time, they were producing a new line of industrial controllers with LED displays, rather than the older analog meter movements, to show process deviation from set-point. A stack of RC4136 “quad 741” op amps was used to drive the LED bargraph display. There were two display modes: single dot and bargraph. (That sounds like a Raytheon part number. /rap)

During burn-in, many of the bargraph displays would go into full-scale oscillation at a rate of about 2 to 3 seconds per cycle. Failure analysis showed that the current required for an RC4136 to drive four LEDs was enough to melt the V_{SS} bond wire inside the package, but not enough to destroy the device. The oscillation was the bond wire expanding, detaching, cooling, and re-contacting the bond pads.

(Wild! Was the amplifier in an extremely high-gain circuit? And, was it driving an excessive load? I know a 741 can typically drive a lot more than it’s rated to, but as you discovered, you can get in trouble doing this. /rap)

These devices would oscillate in this fashion during days of burn-in and still function just fine in single-dot mode when pulled out for final test! RAY BOWEN

HELLO, RAY,

Wow, what a great story!

RAP

BOB,

In looking over the schematic for the fancy PNP, I could not help but wonder

about something (“What’s All This *PNP Stuff, Anyhow?*” Sept. 11, 2008; *ED Online 19605*). The current sources for sink and source are about 1 mA, while the current that is to be reflected into the output is 0.1 mA to 10 mA. Any mismatch in the sink, and source currents are going to show up in the output. (Yeah, but these currents are going to match well. That’s why I defined those current reflectors. /rap)

I might be missing something. If the base of the PNP is a low impedance point (Isn’t it a negative impedance point? So when current is dumped into it, it comes out the NPN’s collector and comes back out the PNP’s collector. /rap), you have a common base transistor configuration. And in this, the current gain is about 1. There is voltage gain, but the Miller C is removed as it is shunted to ground and does not reflect the driving circuit and cause slow down.

JIM P.

HELLO, JIM,

You are a DAC man. Don’t be bamboozled by “paralysis by analysis.” It works! You could even build it in nine minutes.

RAP

SIR,

The Early effect is quite confusing to me. Most textbooks talk about the Early effect only in the CE configuration and do not give finer details. Why are we not observing the Early effect in the CB output characteristics? (Because it is beta times smaller in the grounded base, so it is just less noticeable. Note: the Early effect in grounded-base is largely invariant of beta. In grounded-emitter, it is largely proportional to the beta. /rap)

Is it because we keep base emitter voltage constant to get constant I_E (No. If V_{BE} were kept fixed, the Z_{OUT} would get lousy again. /rap), unlike in CE where we need constant I_B ? As in CE, I_C will increase

due to a decrease in recombination at the base and due to an increase in V_{BE} ($I_C = I_S e^{V_{BE}/V_T}$) but more due to the latter, and in CB, only recombination affects I_C . (Not really. You throw that around as if I_S were a constant. It is not. See what I said about I_S in “What’s All This V_{BE} Stuff, Anyhow? Part 1,” at www.national.com/rap/Story/vbe.html, and in Part 2, June 21, 2007; *ED Online 15690*. /rap)

If so, then the change in I_C that we observe on the output characteristics shows the effect of base emitter voltage on collector current than that of base-width modulation. Is there a way to find the Early effect in CB configuration experimentally (measure hrb and measure hre; measure Z_{OUT} with fixed base drive, or fixed V_{BE})? (Why is the output impedance at the collector about the same when I_B is held constant or when V_{BE} is held constant? Think about it. /rap)

I read somewhere that since the base is very thin when further reduction happens due to the Early effect, the injection of carriers from base to emitter also decreases. So, this also should decrease the base current. (I don’t think there is anything there to see. When you measure I_B , you can’t tell if it is from the injection or from the recombination. /rap) Exactly what things get changed due to the base-width modulation? (Many things. /rap) Please help.

GANESH NITHYANANDAM

HELLO, GANESH,

Please, go measure some transistors. Help yourself.

RAP

Comments invited! czar44@me.com —or:
R.A. Pease, 682 Miramar Avenue
San Francisco, CA 94112-1232

BOB PEASE obtained a BSEE from MIT in 1961 and was a Staff Scientist at National Semiconductor Corp., Santa Clara, Calif.

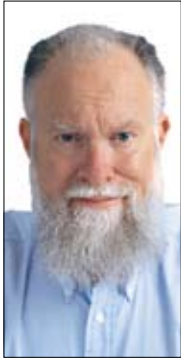

What's All This Bridge Amplifier Stuff, Anyhow?

I was helping some engineers working on a strain-gauge preamp not too long ago. We had it functioning, but there seemed to be some bad linearity problems. We even set up a little calibrator and tried to get it linear, yet we kept getting odd errors, using the conventional amplifier setup per Figure 1.

The guys said, "We don't have to worry about precision or calibration because we're calibrating it in software." I went in with a digital voltmeter (DVM) and started measuring *real* signals.

One of the major problems turned out to be the zero-point calibration. The strain-gauge was nicely trimmed for zero output at zero force, and the first preamps (LMP2022) had zero output. But the second amplifier stage output was then nowhere near ground.

Oh, yeah. They had been using the third amplifier as a "rail-to-rail" amplifier. These so-called "R/R" amplifiers don't really go to the rail, though. Maybe within 10 or 25 mV? It turned out there were three problems.

THREE PROBLEMS

First, to run the third amplifier, they set up its input/feedback resistors as 1k/2k. They woulda been a little better off at 100k/200k. Second, the amplifier won't go to the rail, but just close. And third, they had put in the resistors at 1%. They were still saying, "We don't need precision amplifiers or resistors, as we'll be calibrating in software."

I'm beginning to get grouchy about such people. I explained that using 1% resistors, the common-mode rejection ratio (CMRR) of the third amplifier can be as poor as 37 dB with respect to the input or 31 dB at the output. They said they were assuming there would not be much CM noise.

I pointed out that that's not a safe assumption. Plus, the center of the bridge is at about 2.2 V, so there's 1.5 V of V_{CM} . Using 1% resistors, the output may go to +60 mV or -60 mV, per my comments on error budget (see "What's All This 'Error Budget' Stuff, Anyhow?") at www.electronicdesign.com, *ED Online 12629*.

Since there's no way the output can go to -60 mV, this is doomed! What if we put in a couple bucks to buy 0.1% resistors? The whole project is still in trouble. Now jump to Figure 2, which is based on my error budget circuits.

Input differential voltages from 0.00 to 50.0 mV will be converted to a

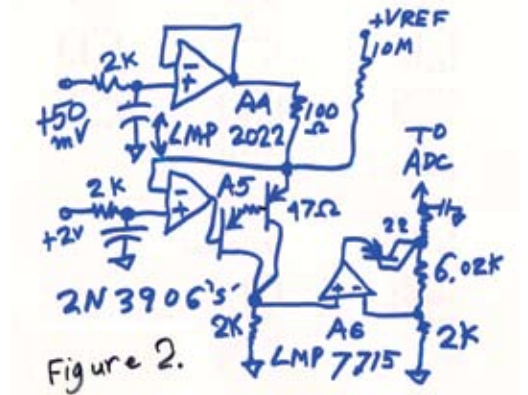

current, which flows through the Darlington, down toward ground, with 0.01% accuracy and even better linearity. The op amps' low ($5 \mu V$) offsets will provide very good precision. Then A6 (LMP7715) can easily magnify the signal up to the +4.0-V input that the analog-to-digital converter (ADC) would like to see. And the whole thing will swing close to ground.

So even in real-world conditions, we don't have to "assume" that an "R/R" amplifier can "swing R/R." It takes good strategy to get this. And now, the "software calibration" will surely work well. So the engineers said, "Good! Now we are ready to do 11 and 12 bits of accuracy and resolution!"

I responded, "Like heck you are! Show me the error budget on your V_{REF} , which as a bandgap surely has a lot of voltage noise!" We went over this and added some filtering. And, we put the same amount of filtering on the signal fed to power the bridge. They finally figured out that wishful thinking does not lead to good S/N. Good engineering can.

One of the engineers said, "It looks like you're just solving the problems by throwing a lot of silicon at the problem." I pointed out that the silicon is very cost-effective. It's the screw-ups that are expensive, as well as the ability to get something good enough to ship consistently. "It's bad product design that's expensive," I said.

I may no longer work full-time for NSC, but I know how to use good NSC amplifiers to do precision work—not just wishful. ☺

Comments invited! czar44@me.com —or:
R.A. Pease, 682 Miramar Avenue
San Francisco, CA 94112-1232

BOB PEASE obtained a BSEE from MIT in 1961 and was a Staff Scientist at National Semiconductor Corp., Santa Clara, Calif.

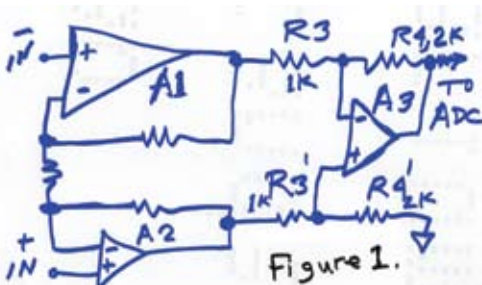

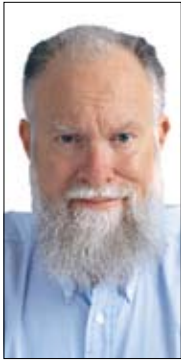

Mailbox



HI BOB,

I read your response to Arthur Williams in the April 23 column (“*Bob’s Mailbox*,” p. 56). The answer as to whether or not to remove the ground plane underneath inductors is: it depends. If the inductors are cans or toroids, it does not matter as the fields are contained inside the inductor. If the inductors are air wound or chip inductors, it might be best to try and see if it improves. At 28 MHz, strip line and printed inductors won’t be used, but remove the ground plane for these. The main concern with inductors is the groundplane killing the Q through coupling. (I think you have the right insights. Thank you. /rap)

If you don’t know how to use ground planes, they can cause more problems than they solve. Ground planes should be segmented into digital and analog planes at the very least. If you know what you are doing, it is not hard to make digital and RF and analog live on the same board without shields. (If you are not sure what you are doing, those darned shields may make good Band Aids. I know several good engineers who have learned that segmenting the ground planes into digital and analog ground planes can make a big mess if you have any signals crossing those demarcations. /rap)

I enjoy reading your columns and regard them as continuing education.

RADCLIFFE CUTSHAW

HELLO, RADCLIFFE,

Well, I think you could see that this is an area where I am not an expert, so this time I am learning from you! **RAP**

HI BOB,

I’ve used the LM393 dual comparator in many, many applications. Usually, the open-collector output would be used as a logic signal, with no special requirements, other than a pullup resistor. However, I have

a new application where the open-collector output is wire or’ed into a switching node. Therefore, the capacitance of the open-collector output is now critical. I could not find this spec’d anywhere. (If you look at the typical output curves in the datasheet, some of the waveforms may indicate if the C is large or small. /rap)

Do you know what I could expect for capacitance (to Vee or other internal nodes) for this open-collector output? (You are probably the first guy to ask the question in 10 years. Nobody at NSC will remember the answer. I think it will be more than 5 pF. Maybe 20? Probably less than 50 pF. Surely less than 100. To save time, just measure it yourself! Use a low-capacitance probe. And be a good sport and let me know the answer. /rap)

Also, the switching node is driven from other circuitry and will be switching from 0 to 1.2 V at approximately 200 kHz. Do you think this switching waveform on the open-collector output node will “disturb” the comparator at all (through internal coupling within the comparator)? Obviously, when the open-collector output pulls low, it defeats the (externally driven) switching function.

BOB BUONO

HELLO, BOB,

The LM393 circuit will not care, and its performance will be unaffected. However, your layout of the printed-circuit board between the output pin and the positive input and negative input pin will possibly have some effect. So, it might be a good idea to keep those printed-circuit foils separated. This is not an LM393 problem. This is a

comparator problem, and a layout problem, and it applies to every comparator application. Every one in the world.

You might want to add a tiny bit of positive feedback from the comparator output to the positive input. Perhaps 2 mV? Standard application for comparators. **RAP**

HELLO MR. PEASE,

Can you direct me to some published results or describe the output phase of the standard LM317 regulator as a function of frequency? I am particularly interested in the frequency region where the regulator Z_{OUT} becomes inductive.

(There is no simple answer to that. That’s because the phase changes to be inductive, and the inductance is a function of the load on the output. One of my techs did a study on this, and it has been published in my *Troubleshooting Analog Circuits* book, back in the appendices. I’ll try to find this and scan it soon. If I goof, remind me. This effect can also be minimized by putting zeners or big caps at the adjust pin to ground. Do you want to know everything these is to know about the phase, or do you just want the output error to be as flat and low as possible? The latter is easier. Have fun. /rap)

I am not an engineer. This is just a hobby for me. My main gig is as a neuroscientist. If you ever have any neuroscience-related questions, please feel free to ask. I would like the opportunity to return the favor if you do decide to respond. **TIM JARSKY**

HELLO, TIM,

No problem. Best regards. **RAP**

Comments invited! czarr44@me.com —or:
R.A. Pease, 682 Miramar Avenue
San Francisco, CA 94112-1232

BOB PEASE obtained a BSEE from MIT in 1961 and was a Staff Scientist at National Semiconductor Corp., Santa Clara, Calif.

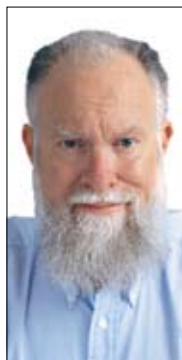

What's All This Knot Stuff, Anyhow? (Part 4)

When I was about 16, I went to work at Consolidated Cigar Corp. in Broad Brook, Conn. Shade-grown tobacco, under tent-cloth. I bicycled over there every morning in the summer. One of my first jobs in June 1957 was tying.

All the tobacco plants had to be tied up with a string, to a wire overhead, to keep them from flopping over in bad weather. There were about 30 plants in a “bent” that was 30 feet long. We got paid about 11 cents per bent, as piecework, so we got pretty good at it. Even the first week, I got up above 10 bents per hour.

The basic deal was to make a “lark’s foot” per the bottom of the sketch. Take the tail of the string, reach it around the stalk of the plant, and poke it into the loop. Then snug up the string, so the lark’s foot grabs the tail—and stand up and break the string as you rise. And make a quick clove hitch over the horizontal wire, as shown up at the top. Then, dive down low, making the next lark’s foot as your hands descend.

Repeat as needed—about 10,000 knots per day. With most kinds of cord or rope, a lark’s foot does not make a good grasp of the tail. But the string we used was so soft, it made a very stable and reliable knot.

And how did this string keep the tobacco plant from flopping over? The next task was twisting. We had to go back and spiral the string around the stalk a couple times, as it grew taller, so that kept it from being knocked down in wind or rain or heat.

PRACTICE MAKES PERFECT

By my second year I was up to 18 and 20 bents per hour. In those days, \$2 per hour was pretty good pay for a kid. We were very competitive about tying a lot. We figured out strategies to avoid wasting time.

For example, I would tie every even plant on the way up the row, and on the way back, I’d tie the odd ones. Sometimes I would use a small ball of string and pull the string from the inside, so I never had to throw the ball, but just let it lie there. I was very careful to avoid wasting string. Sometimes the straw-bosses would start to hassle me, but I never goofed up.

When you start on a bent, there isn’t much tension on the wire. Every time you add a string, the wire would sag a bit lower. We had to compensate for this

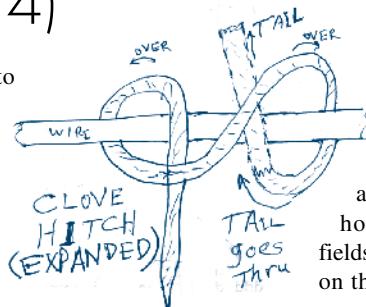

sag and never let the strings get too tight nor too loose, even when the wire sagged.

By my third year, I could average 20 bents per hour for 7.4 hours. (They threw us out of the fields about 4:40 p.m. so we could get on the bus and go home.) There was one young woman, Sandra, who could

tie about 19.7 bents per hour. For a slim gal who was an inch shorter than me, I thought that was a very gutsy performance. I was impressed. She, and many of the girls, had to put Band Aids on their fingers so the string wouldn’t cut them too much. But she never beat me, over a day.

Anyhow, after about three weeks of tying, we were in good shape but all worn out and ready for other tasks. I did about 40 different tasks on that farm. It really was quite educational. I did almost every task except plowing and transplanting. Those came too early in the season, when I was still in school.

And here’s something I found quite amusing that I only found out 45 years later. Our paymaster Helen was in her office one day, and two serious men drove up from headquarters in Wethersfield.

“We want to see about this Bob Pease who is cheating the company. *Nobody* can tie at 20 bents per hour,” they said. Helen shrugged and told them where we were working that day. She told them, “He really can tie 20 bents an hour. I see him do it every day.”

They went out and watched me. I was doing about 21 bents in an hour. I would have done an even better amount, but we had to walk 150 yards between fields. They went away. I never saw them or talked with them. I guess they were mollified.

I only learned of this a few years ago. I sure did laugh! So I tied about a half-million knots in my three years and never did tying again. But it was fun when we were doing it. ☺

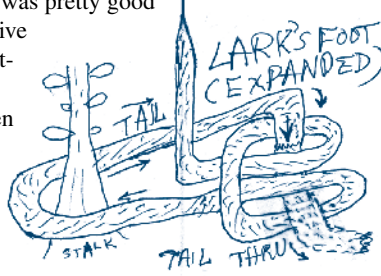

Comments invited! czar44@me.com —or:
R.A. Pease, 682 Miramar Avenue
San Francisco, CA 94112-1232

BOB PEASE obtained a BSEE from MIT in 1961 and was a Staff Scientist at National Semiconductor Corp., Santa Clara, Calif.



Mailbox



HI BOB,

I like your bridge amplifier (“*What’s All This Bridge Amplifier Stuff, Anyhow?*” June 11, p. 56; *ED Online 21190*). I can’t figure out what the V_{REF} driven offset into the first stage does (It is just a tiny bias, so if the input goes $\pm 12 \mu\text{V}$, the circuit will keep on working. /rap) and I can’t figure out what the diode-configured transistor in the final stage does. I request your words of wisdom. (The output of a “rail-to-rail” amplifier can not swing all the way to ground. It might stop at $+6$ or 9 mV . The output of the circuit shown will go down to 2 or $3 \mu\text{V}$. /rap)

As always, I am deeply interested in your trekking experiences. I just turned 60. I suspect you are a couple of years beyond that. (I am 68, but my trekking stories are still on my Web pages. /rap) Two years ago, my sons led me to the top of Half Dome, Yosemite. By the time I got to the top, I was dead, exhausted, finished. Trouble was, I still had to get back. Lucky for me it was all downhill, or they would have had to evacuate me. (I have never had any need or wish to go up Half Dome. /rap)

The last time I read about your hiking, you suffered a bit of frostbite. Are you okay now? (My toes are still uncomfortable, and so are the rest of my feet. My legs are in lousy, poor shape, but I am starting to get back. /rap) Still hiking? One of these days, I hope to cross paths with you in the Sierras. My sons want to do Mt. Whitney next. I think I am a bit long in the tooth for that. Have you been there?

BOB SIEFERT

HELLO, BOB,

I have hiked halfway up Whitney, but I like I said, I never got very interested in going to the top. I have hiked high enough in Nepal that at the saddle point of Thorong La (a col), I could spit down 3000 feet onto Whitney. And I’ve been 1000 feet higher

than that at Kala Pattar and Everest Base Camp. And we had very good views. We ascended 1000 feet per day to get up there, with very good acclimatization. I think it is a brutal mistreatment of your body to rush up to 14k with no acclimatization. You are just asking for trouble, headaches, and altitude sickness when you go up fast as people do on those fourteeners. **RAP**

HI BOB,

Great column (“*What’s All This Bridge Amplifier Stuff, Anyhow?*”). I measure my progress in analog skills by how far I can follow you and if I can spot the problems before you describe them. The feedback resistor size seemed low to me, more because I’ve been doing a fair amount of micropower stuff. Besides, we used 10k/20k resistors back with 741s.

(Well, I agree that 1k/2k was pretty low. But these days, many op amps can drive 1 mA without even $1 \mu\text{V}$ of input error, and older op amps couldn’t say that. Also, many modern op amps can go from 1k/2k to 100k/200k without causing even 10 mV of error due to I_{BIAS} . /rap)

The rail-to-rail issue was learned painfully years ago—best to treat a rail-to-rail op amp like something halfway between an LM324 and a perfect op amp. (Yeah, and if that ain’t good enough, change the topology! /rap) If Figure 1 has the output of A1 and A2 each at a perfect 2.0000 V, what would be the output of A3, if we had a -1.0-V supply to run A3? **JIM STEWART**

HI, JIM,

Any one of the four resistors around A3 can cause a 13-mV error in V_{OUT} if it is off by 1%. If all four R’s gang up and drift 1% in the wrong direction, V_{OUT} could be as big as -52 mV or $+52 \text{ mV}$ —a truly sloppy performance. Even if the 1% resistors were improved to 0.1%, you would still have a $\pm 5\text{-mV}$ error, max. No, we can’t toler-

ate that kind of error, even if the amplifier could swing to -5 mV , because the analog-to-digital converter can’t detect a -5-mV input! So, it just goes to show that putting some 1% or even 0.1% resistors in a circuit does not make a precision circuit! **RAP**

HELLO BP,

I just read the bridge amplifier article. How about using 1% thick-film resistor-pak with mostly matched and trimmed elements? I think that would help make a predictable performance product. (If you need pairs of matched R’s, same value, not so bad. But two R’s at 50Ω and 1k will not have good tempco tracking or stability. It’s best to buy a couple of discrete R’s at low tempco. If you shopped for 50Ω and 2k, you couldn’t find ’em! Even buying a thin-film network with those values is hard! /rap)

I recently read the reprint of “*What’s All This Double-Clutching Stuff, Anyhow?*” (*ED Online 6137*). I used to have a Datsun 2000 five-speed and could shift up and down as fast as you could throw the gear lever. I think those gears must have been turning together all the time. (Oh, the gears are in constant-mesh, but the synchros have to change. /rap) I only used the clutch to get it rolling or when I was behaving.

And, I had hoped to catch one of your on-the-road shows. If you are traveling out this way, I would entertain!

GEOFFREY CAMPBELL

HELLO, GEOFFREY,

Thanks for the comments!

RAP

Comments invited! czar44@me.com —or:
R.A. Pease, 682 Miramar Avenue
San Francisco, CA 94112-1232

BOB PEASE obtained a BSEE from MIT in 1961 and was a Staff Scientist at National Semiconductor Corp., Santa Clara, Calif.



What's All This "Little Guy" Stuff, Anyhow?

I've heard some people say, "Yeah, Pease is often very attentive to the Little Guy, to very small customers. He'll even send a couple samples to a guy who may never even spend any money." When they say this, they're condemning how I waste time on non-customers. I won't deny it. Sometimes I do.

But I think it's only fair if I get my chance to tell the other side of the story. It's very true that sometimes, I'll send out a sample to a guy who sorta admits he isn't a big customer. But if he builds something and it works, he may say really good things about the circuit. We've seen that happen.

He may write a good story in a magazine. He may be a hobbyist who will soon decide to design in some of my parts in his day job—in a real military or industrial application. He may be a good customer in disguise. I think that's good for business.

I'm willing to make the gamble, the investment. Even if he doesn't buy something soon, we have probably made a friend, and I think making friends is even more valuable than making short-term profits.

LEARNING FROM THE LITTLE GUY

Sometimes a guy asks enough dumb questions that I decide to spend 10 or 40 minutes telling him how to do a task. Sometimes, this too is a big waste of time. But sometimes this is a good educational experience for me. I'm almost never as wise as after I crystallize my thoughts well enough to teach a customer.

Some of my columns are based on a simple customer question. So are some of my application notes and even some of my products. Answering a customer's questions may lead to some really valuable results.

One guy asked me about using a wheatstone bridge with high impedances. Figuring out how to do it was a good challenge. When I was in school, we had wheatstone bridges to measure 10k, but not 10M or 100M or 1000M. Guarding and shielding is a major factor. Put it inside a big cake pan. Put tin foil over the top.

If some friend hadn't asked me, "Is it true that only fuzzy logic can do this?" I never would have dug into the problem of the truck speed controller in November 2000. I designed and started building a PID controller for an imaginary truck, which led me to see that most of the fuzzy bragging is baloney because fuzzy systems (almost always) excel only when compared to an artificially crippled conventional system.

I soon learned that the claimed advantages of fuzzy logic are bogus. I wrote letters to all the supposedly expert fuzzy-logic guys explaining why. They never wrote back—not even to mention the superiority of voltage regulators optimized by Mr. Taguchi.



Air Force photo

Sometimes I send out samples and an apps circuit asking the guy to let me know how it works. Often I get no response at all, but at least the guy goes away happy. Other times I get a small avalanche of amazing data, which again can be very educational. Or, it may be confrontational! Sometimes the guy says, "Your ideas didn't work worth crap. The circuit didn't work like you said. Now what?!"

Then I may have to rethink my problem. Or I may have to build it myself. I know a guy who designed an engine control system for the F-86. It was alleged to not work right. He had the courage of his convictions. He built it again, and it worked just fine. Sometimes you have to be ready to build a circuit or system to prove that it really does work.

SAFE DRIVING

My book on safe driving, *How To Drive Into Accidents—And How Not To*, came out 10.5 years ago. I have already gotten a few letters from pleased parents: "My son just got his 10-year Safe-Driving Award from his company, and I think it is because I bought him (and made him read) your excellent book. Thank you!" The book is still in print at \$21.95. For more information, inquire by e-mail. ☎

Comments invited! czar44@me.com —or:

R.A. Pease, 682 Miramar Avenue
San Francisco, CA 94112-1232

BOB PEASE obtained a BSEE from MIT in 1961 and was a Staff Scientist at National Semiconductor Corp., Santa Clara, Calif.

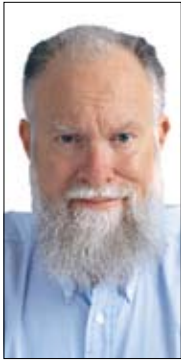

Mailbox



HI BOB,

Quite some time ago, I sent you a circuit similar to this file (*see the figure*). You were very kind and answered all of my questions. However, one thing you said was that the noise gain of this circuit is 1. How did you arrive at that value?

(If the V_{OS} of the op amp changes by 1 mV, the voltage across the load R will be changed by 1 mV. The delta V_{OUT} of the op amp will be the same 1 mV, so the dc noise gain will be 1.0 by inspection. Now at 10 kHz, the noise gain will surely rise above 1. It should never be a surprise if the noise gain rises. This could easily be because the Z_{IN} of the op amp is capacitive, and the Z_{IN} of the MOSFET will be capacitive. So, the noise gain can rise at 9 to 12 dB per octave. This will lead to oscillation and instability. One of the first Band Aids is to put a small CF or series R-C network from the op amp's output back to its negative input. Maybe 100 Ω and 100 pF? Don't try just one value. Try several R-C values and see what works better in terms of not so much ringing. Have a ball! /rap)

The formula I have for noise gain is $(R_F/R_{IN}) + 1$. (Uh-uh. It is $Z_F \times (\text{sum of all input admittances}) + 1$. Your formula only applies to a case of an inverting op amp. The definition is delta V_{OUT} /delta V_{OS} , and it will be frequency-dependent. /rap) So in my circuit, I'm assuming $R_{IN} = R_2 = 1k$. What is R_F in my circuit? (Not applicable. /rap)

Or is there a different formula to calculate noise gain for my circuit? Why I'm asking about noise gain is that, as you have pointed out in your article on noise gain, noise gain affects stability (*see "What's All This Noise Gain Stuff, Anyhow?" at www.electronicdesign.com, ED Online 7164*). So, I'd like to understand how the stability of my circuit is affected by noise gain.

RICHARD DZIOBA

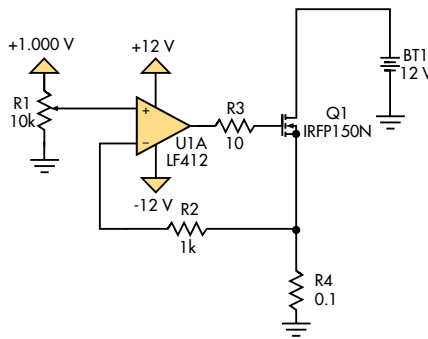

HELLO, RICHARD,

If the noise gain stays low or constant, you are usually in good shape for stability. If the noise gain starts rising, at mid-frequencies, it's important to do something about it.

RAP

DEAR BOB PEASE,

I wonder why Early voltage never seems to be shown on a transistor sheet. (Or am I wrong about that?) (When transistors were new 40 years ago, they would show a typical family of I_{OUT} versus V_{CE} for various values of I_B . You could use that to estimate the working range of V_A . These days, paper is too expensive. /rap)

It seems to me that would be useful information, even if it's only a range. (I'm thinking it would help a person to estimate the output impedance of a current source particularly.)

(High-beta transistors tend to have low V_A , and low-beta transistors have high V_A . What you want to know is the product of $\mu \times \beta$, which tends to be a constant for any specific type. Different types may have higher or lower for the product. Also, is that product 1 million or more? Or lower? Then if you know the range of β , you know the range of V_A . /rap)

Until recently, I had thought the range was narrow, so it might be settled by measuring the effect for a few transistors. But

I learned better. A colleague's data taught me that the range of V_A from a super-beta's to a high-voltage part is very wide: from about 130 to 6400 (430 for a 2N4904). (And it can also go as low as 50 or as high as 25,000. /rap) Is there a complication that I don't know about that precludes giving this specification?

TOM HAYES

HELLO, TOM,

Hardly anybody asks for it. And those that need this info know how to get it. Now you do. Have fun!

RAP

HELLO BOB,

Here is a little something for you to think about. How do I drive a high-impedance microelectromechanical-systems (MEMS) filter from a 50- Ω source and then transition back out to a 50- Ω load and keep 50 Ω friendly?

DAVID SMITH

HI, DAVID,

You must ask the guy who makes and sells the MEMS filter. I mean, how am I supposed to guess what the MEMS likes to be loaded with? I have no idea.

If it likes to see a high-z load, then use an op amp as a unity-gain follower. Or an emitter follower. Or a source follower. Or a current-feedback amplifier. Let it drive the 50 Ω .

The fact that you say you want to work at 50 Ω indicates that you have some pre-conceived notion of the frequency range where this is supposed to run. And I can't guess that either. And if you ask Dear Abby, I bet she can't guess either!

RAP

Comments invited! czar44@me.com —or: R.A. Pease, 682 Miramar Avenue San Francisco, CA 94112-1232

BOB PEASE obtained a BSEE from MIT in 1961 and was a Staff Scientist at National Semiconductor Corp., Santa Clara, Calif.

WIRELESS
EVERYWHERE

What's All This Trust Stuff, Anyhow?

I'm several years late figuring this out—since November 2000. But I learned something this spring—March 24, 2009, to be exact. I had just hiked down from Everest Base Camp (at 17,800 ft) past Gorak Shep to our camp at Lobuche (15,200 ft) to rejoin the other members of our trekking group.

The next morning, I went up to Kongma La (La = pass), which was a “short-cut” pass to the small town of Dingboche. The others took the gentler route, all downhill. But I took the “short cut,” with more than 2000 ft of ascent and 4000 ft of descent.

Now, I gotta say, above 16,000 ft, I was not blindly fast. But I was in fairly good shape for a gringo, and I was definitely in the best shape of anyone in our party. Nobody else wanted to come with us. So I started out with our sherpa and guide, SalamSing Tamang, whom I had known for 10 years.

He goofed easily up the hill. I worked hard and took many little breaks, as gringos often do at those altitudes—16 steps up, and four or six steps worth of wait. I paced myself, as I could see there were no easy parts of the hill. When we got to the top, we had a glorious view of a couple of lakes and tarns and a big, broad valley. Surprisingly, there were no yaks in it. They had moved out already! The Nepalis take good care of their assets.

ACCORDING TO THE BOOK...

The guidebook indicated that the trails in this valley were rough and obscure. But the book must have been old and out of date. The trails were a bit rough, but very easy to follow, and we descended easily and surely. I never slipped or fell. I stopped at a small stream where I refilled my water bottle with a dot of iodine for purification. On the downhill, we did not get very dry.

We descended part of a mile, and then SalamSing veered off to the right to see if we could shave off part of a mile. We went off the trail and descended some steep gravel slide slopes for 20 or 30 minutes. In fact, I don't think we saved 20 minutes, as the trail was nearby. But it was the adventure of it. Sheer inertial trailblazing, even if trivial. I mean, we could see down into the river valley. We could see the hikers and the yaks. We couldn't get lost. It was a clear, sunny day.

After we got to the foot of the steep gravel, we stopped and SalamSing lit up a cigarette. I took one



puff. That's the only tobacco I've had for 10 years. Then, SalamSing said, “Are you okay to hike down from here to Dingboche?” I said, “Sure.” So he started scampering down the slope, as Nepalis often do. He was soon outta sight! And I angled down slowly and carefully to Dingboche. I didn't even see anybody for an hour. Barely one yak. But I wasn't worried.

And what I only figured out in March was that SalamSing trusted me. If I had screwed up and

turned an ankle on the way to Dingboche, he would be embarrassed as a guide, and I would be embarrassed as a hiker. Yet we both knew I was good hiker and would not do anything stupid.

A BUCKET OF TRUST

It took me nine years to figure that out. I think I got to Dingboche about 80 minutes later than he did. SalamSing dumped a bucket of trust on me, and I responded okay. (He knew I had done a lot of solo hiking for several days, and I didn't screw up much.)

The funny thing was that up at Everest Base Camp, the previous day, the guy who was guiding me was a young porter, Puri Rai. He said, as we were descending, “Will you have any trouble getting down to Lobuche?” I told him “No problemo,” since we were already on the Airline Trail. (See www.national.com/rap/nepal/index.html, parts 10 and 11.)

So he trotted off down to Gorak Shep (which means Dead Crow) and Lobuche, far ahead of me, and I didn't see him for hours. Problem was, at the south end of the Airline, I thought we had to ascend a few hundred feet above the Airline to get on the descending trail, and I screwed up and temporarily got slightly lost and delayed. But I soon figured out how to get back to Gorak Shep and then to Lobuche as the sun was setting. No problemo.

So if you want to go on a good trek in Nepal, ask Peter Owens (peterktm@mos.com.np) to set you up with a good guide like SalamSing Tamang. ☺

Comments invited! czar44@me.com —or:

R.A. Pease, 682 Miramar Avenue
San Francisco, CA 94112-1232

BOB PEASE obtained a BSEE from MIT in 1961 and was a Staff Scientist at National Semiconductor Corp., Santa Clara, Calif.

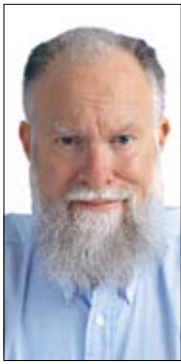

Mailbox



HI BOB,

For no particularly good reason, I'd like to build a variable-frequency power supply to directly drive a small Airpax two-winding, four-wire synchronous motor that drives a turntable. These are small clock-style motors that are made for either 50- or 60-Hz operation at 250 or 300 rpm. Often, they are operated with a capacitor, but a two-phase supply is probably the smoothest way to go. The value of the capacitor is selected for the frequency in use. If the frequency varies (to vary the motor speed), it will be wrong.

What I was thinking was to use a pair of LM1875-based supplies driving a small step-up transformer (these are nominal 110-V motors) supplied by an oscillator that would give me a precise quadrature pair of outputs, something along the lines of the Wien bridge HP bench generators with a variable capacitor. Yes, of course, more modern digital options exist. But I just thought I'd do it in the analog domain.

My goal is to arbitrarily vary the speed of the turntable from about 16 to about 90 rpm in two ranges, determined by the 33-rpm and 45-rpm pulleys on the motor that are used at the standard drive frequency. Could you point me to application notes that might be helpful in this instance? **JAMES ZIKES**

HELLO, JAMES,

I remember an oscillator circuit in AN-31 in our Linear Apps book. There is a "Low Frequency Sine Wave Generator with Quadrature Outputs." This is easy to make, but I don't think it's that easy to tweak or trim over a range. The 0.02 and 0.01 and 0.01 caps could all be switched to set the range. Then you might need a couple of 22-M Ω pots ganged with a 10-M Ω pot. Needless to say, that is a lousy idea! The "High Freq." oscillator is the same idea. You will be working at moderate frequencies. You do not need a precision,

low-distortion sine at either output. You need a pretty good sine. You might be able to gang a couple of LM13700s.

You might even be able to make a truncated triangle wave, and the motor would still be happy. The gain of an LM13700 may tend to drift with temperature, so your frequency might drift around. Maybe lousy. You could build one and try it out. If you're just running it at home, with decent temperature control, it might be okay. But if you took it outside, it might drift lousy.

I know all about triangle waves: how to generate them symmetrically over broad ranges, convert them to sines, and make perfect quadrature matching. Wait a bit and I'll send you a circuit, better than sines. It will make a good column, too. **RAP**

HELLO BOB,

At my first job, a project engineer asked me to find out why his project in production had 25% failures on one particular circuit. It was a 2N706 crystal oscillator driving a 2N706 buffer supplying a local-oscillator signal to a 7-dBm balanced mixer. The buffer output had to have certain RF voltage, and 25% were low. I fooled around before carting half the engineering department's instruments out there and found the difference between radios that passed and those that didn't: the 2N706 buffer had 50 mV more dc voltage emitter to base.

I could fix every radio by putting a 2N706 with the higher e-b voltage in the defective circuit. I reported this and was asked first how many this fixed. I replied, "10 in a row." Then I was asked why my 50 mV dc made any difference at RF, and I answered, "That's a good academic question and I don't know the answer, but I fixed the problem and that's what I was asked to do." My question to you is to provide the academic answer of why a slightly higher dc V_{BE} voltage affected its RF output.

JOSEPH BAGDAL

HI, JOSEPH,

Suddenly after 35 years, it has become a burning question to find out why the yield correlated. Ahem. And then I'll have to ask you exactly what was the schematic of this oscillator. Swapping a transistor is one way to do it. But did you try adding in a little more bias current? I've done that.

I'm not an oscillator expert. I know the guy who was, Tom Mills, and he could answer that. But he had the bad luck to die a few years ago. Your bad luck, too. What frequency was this oscillator supposed to run at? How did you measure the V_{BE} ? Just the two terminals were measured? Or did you measure it while it ran as an oscillator? Whose 2N706s? What year? Obviously, you haven't given me enough information.

I just ran into some good old bifilar-wound transformers for a 5-MHz oscillator that we used 40 years ago. We didn't throw them all out. If it didn't run right, we sometimes changed the transformers, and sometimes the resistor bias. I don't recall that we ever changed the transistors. Good planar resistors are remarkably uniform.

To find some transistors with 50 mV of different V_{BE} , it sounds like somebody at the transistor factory was sweeping a lot of dice into a bucket and bonding them all up. Even the bigger die would meet the JEDEC 2N706 spec, but it wouldn't amplify right. If you opened up the cans, you probably would have found that the two different types of transistors were different geometries. The "bad" ones were probably bigger. That's the best answer I can give you, since you ask 40 years late. **RAP**

Comments invited! czar44@me.com —or:
R.A. Pease, 682 Miramar Avenue
San Francisco, CA 94112-1232

BOB PEASE obtained a BSEE from MIT in 1961 and was a Staff Scientist at National Semiconductor Corp., Santa Clara, Calif.



WHAT'S ALL THIS NOISE-REJECTION STUFF, ANYHOW?

It's well known that audio power amplifiers like to get a good set of grounds, or noise around the inputs may not be rejected properly, causing hum and buzz. So when a guy called me asking how to clean up his interface from his clean audio signals to his LM3886 power amplifier, whose ground system was pretty noisy and lumpy, I thought for a second and replied that the solution was easy (Fig. 1)!

The set of four 4.02-kΩ resistors (1% R's but matched to 0.1%) make up an adder-subtractor circuit—straight from Philbrick's 1955 Applications Manual. Let's stand at the power ground for our scope ground. If there is a quiet signal "out," referred to its analog ground "A," fine. But we must beware of any common-mode (CM) noise, which would appear between the A ground and the PWR ground.

This noise might be related to any kind of ambient noise, or noise on the power amplifier's supplies, or (in a vehicle) automotive transients and radio-frequency interference (RFI). I told this guy, "This circuit will reject any and all such noises." The old equations give you:

$$\text{Amplifier } V_{\text{IN}} - (V_{\text{PR}}) = \\ V (\text{signal out}) - V_{\text{A ground}}$$

I recommended an LME49710, which has 50 MHz of bandwidth and good clean gain and linearity and noise rejection, per www.national.com/an/AN-1671.pdf. I recommended a "gimmick" of teflon twisted pair as CF, starting at 6 in. and unwinding it as needed. I mean, we don't know exactly what kind of noises there will be, or how

much of the wiring strays. Still, the op amp should be supplied with reasonably quiet power that is tied to the PWR ground. The 4k resistors do not have to be closely matched to ensure gain accuracy—but to help give you good common-mode rejection ratio (CMRR), much better than 1% R's will do. If you wanted 80 dB, you'd have to trim them.

OPPORTUNITY

After I hung up, I could not stop thinking of this "problem = ~ opportunity." Why does this look familiar? I thought about some of the problems my colleague Nick Gray had been trying to solve over the years. Hey! this looks just like the problem with analog signals that need to be sent to an analog-to-digital converter (ADC)! You have an analog ground plane and a digital ground plane. But if you try to

just strap the grounds together, you'll get absurd noises.

And if you have one ADC, the CM noise rejection can be bad. But if you have one analog ground plane and one big digital ground plane that are serving two or four or more ADCs, the CM noise coupling can be horrible! What's a mother to do?

The adder-subtractor shown in Figure 2 will reject the CM noises, neatly, using one adder-subtractor per ADC channel. The clean, quiet voltage that is sent in between the signal and VA will re-appear at the adder-subtractor's output, referred to power ground, for each channel. The old equations give you:

$$V_{\text{OUT}} - (V_{\text{DIGITAL GND}}) = \\ V (\text{signal out}) - V_{\text{A ground}}$$

Now, the LME49710 mentioned

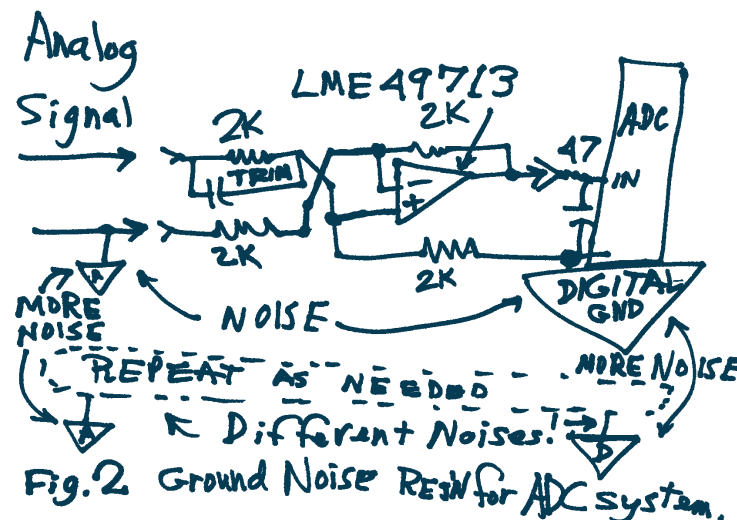
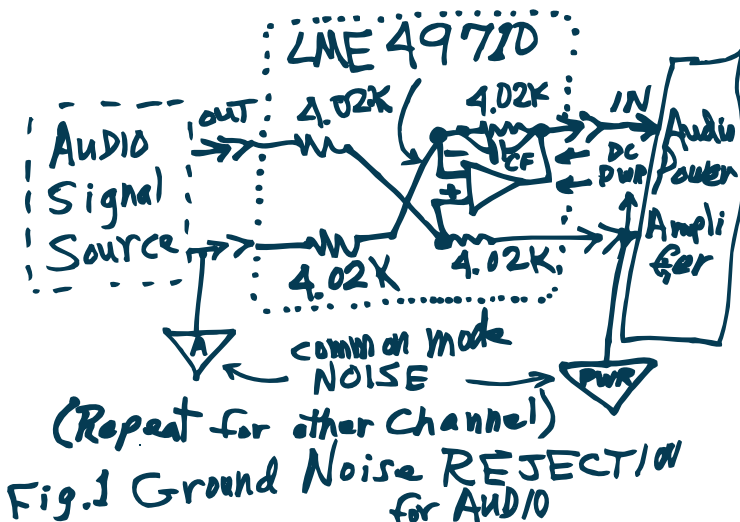

above may have a signal bandwidth of just 20 MHz,

plenty for audio or for some ADCs. It may be trim-

mable to a CMRR of 70 dB out to 2 MHz. That's what I

saw when I actually built it. But what if you need a fast ADC and a lot of CMRR versus frequency?

A KEY MODIFICATION

Let's swap in the LME49713, a fast current-feedback amplifier (CFA), which will pass signals up above 90 MHz, and we may be able to get decent CMRR and noise rejection out past 20 MHz. (The resistors have been cut to 2k to make sure you can get full bandwidth. It might run even a bit faster if you chose 1.2k.)

The LMH6714 can go out to even faster, 400 MHz. But the '49713 may have better linearity. Hard to tell. When you need to do precision work plus fast bandwidth, everything has to be engineered and tested. The circuit might change slightly if you need fast, clean step response rather than just wide bandwidth for sines.

Will that be fast enough for a pretty broad-band ADC? Well, that will depend on the actual circumstances of your system needs. I mean, you could always have more CM noise than this adder/subtractor could quash. I did my testing with 10 V p-p. Could this be used in addition to a Balun? Insert that ahead of the first two 2k resistors. Probably. I mean, when things get fast, then you always have to be prepared to do some real engineering. Still, this is one good tool to add to a good

toolbox, when you have to accommodate (and reject) many kinds of nasty noises, conducted and induced from radiated noise.

For this case, adding a few pF of Cf seemed to be doing more harm than good, so I installed several inches of "gimmick" = twisted pair as a capacitive CMRR trim, for the signal path going to the positive input.

What's the big deal with the "adder-subtractor"? When George Philbrick developed the K2-W, which was one of the first operational amplifiers with differential inputs, it facilitated simple adder-subtractors that did not need a dozen resistors and two or more chopper-stabilized amplifiers and hundreds of watts. George never had access to any 400-MHz op amps as we can easily buy these days. He'd be impressed with modern op amps—and applications circuits.

Can these amplifiers provide a voltage gain other than 1.0? Sure—and you have to engineer it. And to get good results, you always have to plan a good layout. This is just a start, to indicate all the things you can do. ☺

COMMENTS INVITED!

czar44@me.com —or: R.A. Pease, 682 Miramar Avenue San Francisco, CA 94112-1232

BOB PEASE obtained a BSEE from MIT in 1961 and was a Staff Scientist at National Semiconductor Corp., Santa Clara, Calif.

There's A Better Way To Assure The Reliability Of Your Electronic Components



Unmanaged moisture, oxygen, hydrocarbons, or other airborne contaminants can all affect the reliability of your products. Whether you are designing a hard disk drive, a radar system, consumer electronics or automotive system components, Multisorb can offer an engineered (drop-in, fit-in, or built-in) active packaging solution for your specific application.

+1 716.824.8900
www.multisorb.com



MULTISORB
Technologies



What's All This Driving One-Handed Stuff, Anyhow?

The other day, I was shooting the breeze with a colleague who has his private pilot's license. And he mentioned, "But of course, a pilot has to be able to fly well with one hand."

I thought about that. Naturally, he was right. A pilot has so many things to do—adjust radios, adjust trim tabs, hold and fold up maps, etc. A pilot should be prepared to fly with both hands in special cases. But keeping the plane flying smooth and level (or as required) is something a pilot should be able to do well one-handed—and with either hand.

There are many respects where driving a car is different from flying a plane (narrow lanes, 2D versus 3D, etc.), but we don't have to worry about these differences. The main point is that any good driver should be able to drive a car with one hand, a lot of the time, and drive with two hands for special occasions. In severe curves, where the precision of positioning the wheels gets important, and your body mass is trying to move around a lot, there's a good case.

I have corresponded with a guy who is an expert with the Institute for Advanced Motoring in the U.K. I once tried to get in, but you basically have to give up your U.S. driver's license and get a U.K. license. Not so likely.

One of the Institute's books says a good driver should not try to shift up while accelerating in a curve. That made me chuckle. If you are accelerating hard and approaching the redline, why would you *not* shift up? I disagreed with the Institute on several other matters too.

TAKING A TEST DRIVE

So I began to think. How would I do driving one-handed for a large while? Like, could I drive home one-handed? I mean, any 20-second or 60-second stretch would not be too hard. My commute is just a total of about 45 miles and a few dozen curves and several corners.

I put my left hand in my lap and started to drive home. With a little planning ahead, I had no problem doing this. When I got to a corner, I remembered to not be pushy. I also used my knee to trap the wheel as I reached for a better position with my right hand.

How about shifting? This, of course, is a 1969 Beetle. Yes, I know how to shift it without using the clutch at all, but I didn't fool around with that. I just did a quick shift (depress the clutch for about a quarter of a second) and shifted away while I was on a straight road—not hard.

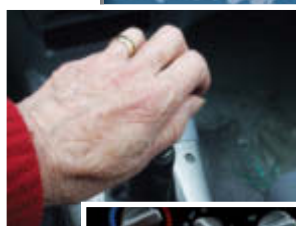

Anybody behind me would not have noticed anything odd. I kept my left hand ready to help, though, in case of a problem. But I never had any problem. I got home fine.

The next day, could I drive to work using only my left hand? I set my right hand in my lap and had no problems. And I never did it again, as I established this was quite feasible.

I remember a story about a guy up in Idaho who had cut his arm very badly. He got his 11-year-old son to drive him 35 miles to the hospital. That was wise, as passing out from lack of blood is a bad idea. I read that the kid learned fast!

Anyway, always driving with both hands on the wheel is almost as silly as never using both hands. How do you scratch your itchy nose? 🐼

Comments invited! czar44@me.com —or:

R.A. Pease, 682 Miramar Avenue
San Francisco, CA 94112-1232

BOB PEASE obtained a BSEE from MIT in 1961 and was a Staff Scientist at National Semiconductor Corp., Santa Clara, Calif.



Mailbox



HI BOB,

Nice article about the “little guy” (*August 13, 2009, p. 56; www.electronicdesign.com, ED Online 21514*). As one of those little guys you once talked to (about the obsolescence of a National Semiconductor liquid-level detector IC), I can relate that the time spent was well received. “Wow, Bob Pease took the time to call little old me, an ex-aero engineer doing mechanical design work” was the response I gave to my colleagues at the time. That I ended up not using the IC or even a derivative of it for my design task is beside the point. That you treated me as a potential customer was a lesson well learned. (Some other day, you might be inclined to buy a National Semiconductor part. That’s fair. /rap)

I know a few other engineers that I pointed your way when they would lament about noise reduction with their op amps. And more than a few suffered my scorn when they spent way too much time trying to amplify, linearize, and calibrate a non-linear thermistor for a one-off temperature measurement circuit. (“Why not just buy a cheapo LM34CZ? Spend \$0.50 more but save hours of fussing with all that other circuitry and effort.”) So maybe your time paid back in intangible ways. I hope so.

(We all like to hit a reasonable balance between parts & labor cost per unit and engineering cost divided by N, all in view of time wasted per unit. Sometimes I like to put in a little extra effort for a frugal solution, even if it’s not justifiable by the quantity. Just as a game. I remember one guy who was trying to set up a resistive bridge with 13 op amps and 16 good resistors to buffer all the Kelvin contacts to two R’s. He wound up using one good op amp and two good resistors. /rap)

I remember an article you wrote about programing your internal “reaction/response” neural network. The idea was to think through the logic table for a given sit-

uation and what you would want, optimally, your response to be, i.e., put your foot in the way of a dropped object if and only if the object is lightweight and expensive (a camera) but pull it back if it’s heavy (cast iron pot), sharp (carving knife), and cheap. I know I have managed to never stab my toe with dropped knives, but did rescue the wife’s video camera with a well-placed foot when I bumped it off the counter.

I related this to the technicians in the shop where I’m now working. (They spend a lot of time working on heavy cast-iron valve assemblies on workbenches, and the subject of safety shoes came up.) They didn’t laugh out loud (to my face), so maybe the lesson got passed on. **BEN TRUEBLOOD**

HELLO, BEN,

Yeah, you have to think this out ahead of time and teach yourself what the right thing to do is instantly with almost zero thinking or wasted time. Thanks! **RAP**

BOB,

Your article on the “little guy” reminded me of when I was in school working on my engineering degree (1962). I had a project that needed to be designed and built as part of the graduation requirements. It required the use of a number of discrete semiconductors. (ICs were few and far apart.) I finished the design and then went to the local semiconductor distributor to see if I could talk him out of some samples. (I usually scrounged for samples first, and then I designed around what I could get! /rap)

I was successful with some and had to buy others, which he sold me at a great discount. Later when working as an engineer, I always used the same brand because of the very positive feeling I received from this rep. Now after many years of engineering work and being semi-retired (I am a consultant), I find that when I contact a company for samples or information and

am treated with “you are too small for us to be concerned with,” I look elsewhere. True, some of my designs are not used in production. But some are, resulting in production runs of thousands. One never knows when the “little guy” turns out to be the one who builds something in his garage that ends up to be a major company worth billions.

LEE R. WATKINS, PE

HI, LEE,

Well, you and I agree!

RAP

MR. PEASE,

I too have invested time in people that do not “qualify” as good customers (under contract). You never know when one of them will contact your next big customer and tell them what a great experience or interaction they had. Last year, one of the “little guys” came back with a purchase order for over 500k. It is rare, but it does happen. If you treat everyone like they are important and listen, it is amazing what you can learn. We are all “little guys” at some point. **JAMES CROWLEY**

HELLO, JAMES,

We once had a request from a good customer who wanted to buy 500,000 of a 6-V version of an existing circuit. That was less than our usual order, but he had a fair question. After much debate, we decided to throw in a metal mask and make it for him. After he got the first samples, he called to apologize for a change. He said, “We need 5 million.” We had no problem shipping those parts. **RAP**

Comments invited! czar44@me.com —or:
R.A. Pease, 682 Miramar Avenue
San Francisco, CA 94112-1232

BOB PEASE obtained a BSEE from MIT in 1961 and was a Staff Scientist at National Semiconductor Corp., Santa Clara, Calif.



What's All This 2401BG Stuff, Anyhow?

Back about 1965, when I was at Philbrick, we were doing some business with Amelco Semiconductor. I had designed a good hybrid op amp (the Q85AH) and Amelco was trying to build it, but they had some test problems, and some yield problems... so I flew out to help find and solve their problems.

The first morning, I put in an hour looking at their test setup. Nothing showed up right away. So we went over to their cafeteria for a cup of coffee. Several engineers were there, talking about circuits. Hey, amplifier circuits! Op-amp circuits!! So I quietly looked over their shoulders and prepared to join in. But shortly I realized they were studying a different op amp—not mine. I became politely annoyed.

“Hey, guys, I flew all the way out here to solve your amplifier problems. Why are you working on this other junk?” They said their corporate leaders had “volunteered” them to design a little seismic amplifier for NASA, for “lunar earthquakes,” and they were having some problems making a good amp design.

“Tell me about this requirement,” I said. “Maybe I can help.” I was trying to get them back to work on *my* amplifier and *its* problems. So they showed me the requirements. I don’t recall how they were written, nor for what specs, but the input had to have high Z_{IN} —a FET—and have low noise, and behave well with a gain of 100 or more, and draw low power.

BACK OF THE ENVELOPE SOLUTION

I scribbled some notes as I looked over their problem. It took me about 12 minutes, using $g_m = 40\text{ i}$ and such simplified rules. So I stood up and told them, “You get a technician to grab *these* necessary parts, and I’ll design the circuit for you in half an hour. The technician can build it up this afternoon... And now you can go back to work on my amplifiers... You can evaluate *your* amplifier circuit tomorrow morning.”

I started scribbling a circuit, and they looked at it, and the list of parts, and thought about it, and sent a technician for parts. They agreed it was quite likely to work okay (*see the figure*). It was (for its day) a very classical, simple little amplifier.

The 120k resistor was the biggest R we could get in the little hybrid package, the largest we could beg, steal, or borrow. I got the gain up over 50,000 when driving $R_L = 100k$. And I beat the power drain goal of 50 mW by a factor of better than 2. Good enough is good enough.

To get the gain good and high, we needed a beta of 300 min on the input NPNs (2N930-type) and beta of 200 on the PNP’s (2N2605’s). I could have gotten a bit higher performance if I had put in more parts, but that

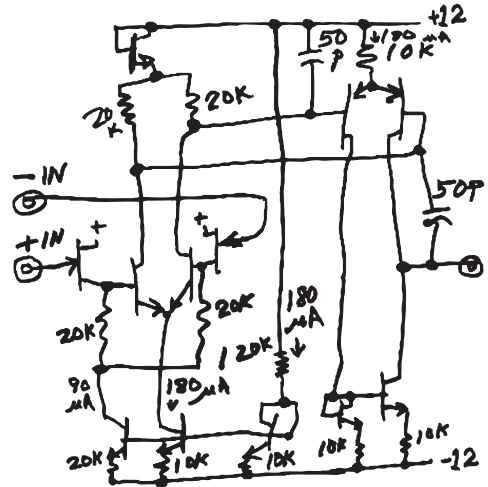

would likely have increased the problem of “We want it to work right the first time, with no trouble.” *That* was a reasonable goal.

I put in some good bias circuits to help make sure it was well-behaved, well beyond the MIL temperature range. Without any serious studies, we knew the temperature on the moon would go well beyond that. I suspect it worked well over 195°C to -95°C, but I never tested it versus temperature.

The first one played as it was designed. Those engineers went off and made up a couple dozen for NASA. They also made up some to sell from their catalog—the 2401BG. I don’t think they ever sold very many, and it was not easy to apply, as it was optimized for a gain above 50 and wanted to oscillate for gains below 20. But, hey, it was optimized for a gain of 100.

UP ON THE MOON

A few of these little fellows were put into “Lunar Seismic Probes” and evaluated fully. When Apollo 12 landed on the moon on Nov. 20, 1969, one set was left behind, parked a few dozen yards from the Lunar Lander, all wrapped in gold foil. It sent back all sorts of noises from various noisy seismic events. So when anybody shows me a photo or mockup of the lunar landing site, I just point over to the corner and say, “Yeah, that’s my junk, over there.” ☺

Comments invited! rap@galaxy.nsc.com —or: Mail Stop D2597A, National Semiconductor P.O. Box 58090, Santa Clara, CA 95052-8090

BOB PEASE obtained a BSEE from MIT in 1961 and was a staff scientist at National Semiconductor Corp., Santa Clara, Calif.



Mailbox



HELLO BOB!

Several years ago, probably more than I really want to recall, I was working as a lab technician for a company developing an ultrasonic liquid level control. It operated by oscillating a pair of piezo crystals when liquid contacted their surface in a sensor probe. The challenge at that time was to design a circuit that would have high enough gain at about 1 MHz to oscillate the crystals and then amplify this signal to saturation at the output so the signal could be reliably detected. In concept, it was a simple switch but needed to operate at this frequency with a 4- to 20-mA current loop. At the time, “high-speed” op amps were power hogs.

So to accomplish this, we decided to use a transistor array and direct-couple several stages to provide near rail-to-rail output oscillation. Since each was direct coupled, the succeeding stages’ bias point was determined by the previous stage output. Everything appeared to work well until the temperature started to dip to -20°C or so, then all oscillation would cease and the circuit would fail to operate.

After some head scratching over this, I remembered that V_{BE} changes with temperature. Assuming a $-2\text{mV}/^{\circ}\text{C}$ shift, I was able to calculate that the bias points were shifting and driving the amplifier stages into saturation. I re-calculated the resistors required to hold the bias points over the temperature range, replaced the old ones with new values, and the circuit worked great from -40°C to 70°C . This was by no means rocket science, but at the same time, I didn’t think it was too bad for a dumb ol’ technician!

JOHN KESSINGER

HELLO, JOHN,

Hey, that is pretty good engineering! Keep up the good work. And the good thinking! I had an old Heathkit radio with six (germanium) transistors that I built

around 1958. It ran well for years. Then I took it out while I was shovelling snow. At 0°C , it sounded pretty bad. I replaced the transistors with decent silicon ones, and I biased up the old class-AB stage with a diode, for temperature compensation, and it worked fine at -20°C .

RAP

HI BOB,

I noted your design piece in the special issue of *Electronic Design* (“What’s All This Noise-Rejection Stuff, Anyhow?” Oct. 1, p. 27; www.electronicdesign.com, *ED Online* 21808). Of course, using an instrumentation amplifier to create a balanced input that rejects common-mode noise is a common practice in industrial audio circuit design. Unfortunately, it isn’t the case for consumer electronics. (I’m suggesting that it might be, if they had the big noise problem we’ve seen. /rap)

Yet we in the broadcast industry are often connecting consumer gear (CD players come to mind) to professional balanced audio inputs with mixed results. Your circuit is a clever way to connect unbalanced to balanced without resorting to magnetics. Audio isolation transformers are the quick and dirty way to fix ground loop noise issues, but high-quality magnetics are expensive and introduce their own distortion and bandwidth limitations on the low end.

Active balancing is considered by most audiophiles to be a superior solution. I tend to favor transformers when the longitudinal noise voltages can be extreme, i.e., telephone lines or long runs between buildings not served by the same power source. (Well, yeah. /rap)

Now, for more fun. Your piece on driving single-handed (“What’s All This Driving One-Handed Stuff, Anyhow?” Oct. 8, p. 56; *ED Online* 21855), while it’s well and good to develop good coordination and teach both hands to be comfortable

with each task that driving entails, I fear it would only encourage folks to multi-task beyond their abilities. I’ve always operated two-way radio gear while driving, microphone in one hand, sandwich in the other, steering wheel on its own. (Kidding!) (You do have two knees, right? /rap)

But most folks have real issues with using their cell phones or applying lipstick while driving. (Most folks are not very good drivers. Most folks are not very good at thinking. /rap) Both anecdotal and experimental data have proven a significant reduction in driving ability and safety when engaged in these multi-tasking activities. And most of those folks are driving automatics, not stick shifts!

IRA WILNER

HI, IRA,

I understand the danger of crashing is increased N:1, where N may be 4. But on many roads, where the road is nearly empty, 4×0 is still 0.

RAP

BOB,

Ehem... N:1 on an empty road is not zero! Plenty of single-car accidents happen if the road is a bit curvy and the driver isn’t intimately familiar with it. It just happened a on the “East West Road,” as it is called in Dummerston, Vt., over the shoulder and into a tree at a curve. Granted, the tree was probably more aware of its surroundings than the driver.

IRA WILNER

HI, IRA,

So the tree was drunk? Or was the tree using a cell phone?

RAP

Comments invited! czar44@me.com —or: R.A. Pease, 682 Miramar Avenue San Francisco, CA 94112-1232

BOB PEASE obtained a BSEE from MIT in 1961 and was a Staff Scientist at National Semiconductor Corp., Santa Clara, Calif.

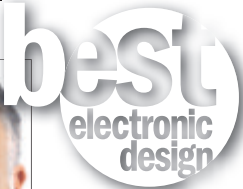

What's All This Best Amplifier Stuff, Anyhow?

After I wrote up that amplifier scheme (see "What's All This Bridge Amplifier Stuff, Anyhow?" June 11, p. 56; www.electronicdesign.com, ED Online 21190), I was thinking about how to get better common-mode (CM) range.

That June 11 amplifier had excellent CM accuracy, but darned little CM range, about +1.9 V to perhaps +2.6 V, which was adequate only for the 4.4-V bridge shown there. What if you want a CM range of ± 2 or 4 or 7 or 10 V? That amplifier was hopeless, but let's consider the CM extender circuits (see the figure).

As the CM voltage goes up and down, A1 acts as a simple follower/buffer and bootstraps the power-supply voltage of the next stages. So, A2 and A3 have basically a constant CM voltage. They have to worry very little about changes in V_{CM} .

Thus, the common-mode rejection ratio (CMRR) can be very good. A6 is set up to bring the outputs of A2 and A3 down to ground. A6 will almost always need a CMRR trim, because the resistors R3, R4 aren't accurate enough. So, P1 is shown.

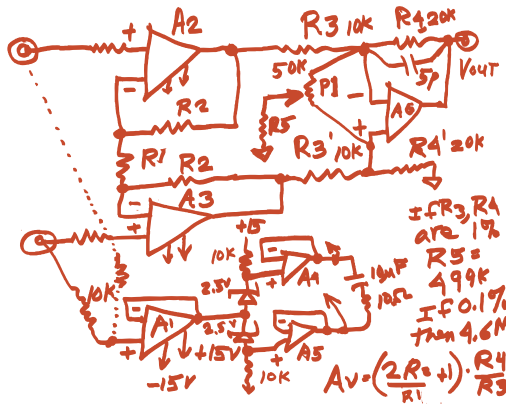

THE PREFERRED EMBODIMENT

If I were a patent freak, I would tell you my "preferred embodiment" of this circuit. The first example is: A1 = LF411; A2 and A3 are the LMP2022 as shown in June 11, and A4 and A5 are LM7332. A6 could be another LF411, or almost any amplifier.

Let's choose $R1 = 100 \Omega$ and $R2, R3 = 10k$, so the first stage has a gain of 201. This can give very low dc offset and drift. The two zeners can be any 2.5-V zener, such as the LM4040-2.5, to give the first amplifier a 5-V total supply voltage. The total CM range is about +12 V to -10 V.

But actually, while the LMP2022s provide excellent dc drift, this composite amplifier doesn't have very low noise for low source impedances. I mean, you can put in almost any type of op amp as A2 and

A3. So, your "preferred embodiment" could put in a couple LMH6624s and get very low voltage noise, such as $1.4 \text{ nV}/\sqrt{\text{Hz}}$, total for the whole circuit, assuming your R_S is lower than 200 Ω .

Specifically, I can never tell you what is the "best" low-noise op amp for your application, until you tell me your R_S and your desired bandwidth and your signal size. As in any amplifier, you have to engineer it for best results, planning for the R_S and those other factors.

So if you want to go to high impedance, you could choose an LMC662, which has 5 fA of I_B and Z_{IN} better than $10^{14} \Omega$. Maybe 10^{16} . The noise voltage is $\sim 22 \text{ nV}/\sqrt{\text{Hz}}$ per amplifier. Or, the LMV651 offers only slightly worse I_B but $6.5 \text{ nV}/\sqrt{\text{Hz}}$. In other words, you can use almost any kind of amplifier, and you choose suitable types—as you always have to!

OTHER CONSIDERATIONS

- High bandwidth: You might want to take a gain of more like 21 in the first stage and 10 in the later stage. Use fast amplifiers.
- High gain: maybe a gain of 201×100 ?
- High CMRR: You will normally need to trim because the output resistors R3, R4 aren't perfect. 1% resistors will prevent you from getting more than about 130 dB (referred to input) with your best trim. Using 0.1% resistors for R3, R4 can get your trim range smaller so you can get 150 dB. Anything more than that, and you have to engineer it. You may be able to get up to 120 or 130 dB without a pot. Refer to my LB-46 (see www.national.com/an/LB/LB-46.pdf#page=1).
- Fast CM signals? A1, A4 and A5 will have to have high slew rate, and you'll have to test for that.
- High output drive? Put a buffer inside the output loop of A6.
- Large input signals, larger than a volt? You may need the floating supply pushed up from ± 2.5 to ± 5 V or more and use higher-voltage amplifiers for A2 and A3.
- Strange CM ranges? Well, you could run the whole amplifier on +20 and -10 V, or +5 V and -25 V, to get an asymmetrical CM range.

Have I built this? Well, mostly in my head, as a paper study. The road to Santa Clara is paved with good intentions. When I realized I would have to build several circuits to evaluate, I just got intimidated and built none of them. But it's still a good framework for almost any strange or wild set of bridge-amplifier features you may want. Have a ball! /rap



What's All This Product Planning Stuff, Anyhow?

What do you do when you want to try out a “new and improved” fabrication process? Typically, you design a variation on an existing circuit that ought to show a useful improvement. You build it and see if the new process will make it work better. You build this as a test vehicle.

What if it doesn't work well? You hope you learn something for the next try. What if it does work well? You test it—and run like heck and sell it! You have to plan for this as a best-case plan. You hope you have planned this circuit so people will want to buy it. As good old Jay Last of Fairchild used to say, “The only valid market survey is a signed purchase order.”

A REAL-WORLD EXAMPLE

That's what National Semiconductor did with the basic 1500-MHz LMH6552 circuit: National souped it up and put in a silicon-germanium (SiGe) emitter process. And it worked at faster speed, as expected. So now, people who want a faster amplifier can buy the LMH6554, which can move twice as fast as the older design.

This improved circuit uses about twice as much current, but it sure does go fast, if that is what you want! It can provide low distortion out past 250 MHz, using its superior gain characteristics. Thus it has advantages per the figure of merit of MHz per milliwatt—it is a good PowerWise amplifier, running at a bare 1/4 W.

The LMH6554, like the LMH6552, uses National's proprietary current-feedback architecture (CFA), so transient currents can flow into both the inputs, positive and negative, to get the outputs moving fast, whereas an ordinary CFA has a high input impedance at the positive input. The LMH6554 also has plenty of output drive, up to ± 90 mA, to drive the time-varying input impedances of analog-to-digital converters (ADCs).

We spent a lot of the higher quiescent current to make the output followers stronger, richer, and healthier so they could drive a heavier resistive load and still hold very low distortion, even at 75 to 200 MHz—and drive switched-capacitor inputs, too.

Another important factor in getting low distortion is the coupling between signals and power-supply bond wires. Ordinary layouts in a small-outline package tend to allow a lot of coupling. When high pulses of power-supply current occur, they can couple magnetically into other signals.

We put this circuit in a more compact leadless lead-frame package (LLP). The extra ground wires and short paths help you get less interaction. There's still

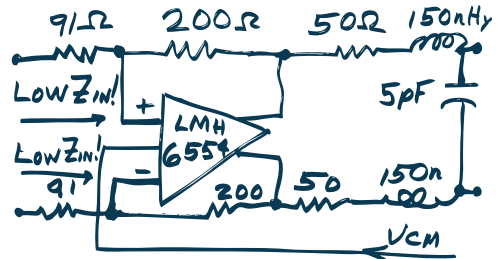

some cross-talk. But in a full-differential (push-pull) output, they can be designed to cancel out when seen by the differential input you're driving. Even inside the chip and between the die and its lead frame, layout can be important. But you probably knew that.

TIME TO APPLY

The primary application of the LMH6554 is for amplifying fast sines and ac signals with low distortion out past 250 MHz and stability out to 2500 MHz. It can feed these sines to differential-input ADCs with high resolution and sample rates well past 100 MHz. These are popular for communication systems and digital scopes.

You may soon request applications note AN-2015 showing how this amplifier can put out fast, clean steps in the time domain. I like that. I'm a time domain man, myself. Guys who know how to optimize for clean sine response aren't exactly the same as guys who can handle fast steps and clean settling in the time domain. Thus it can also drive differential lines for low-voltage differential signalling (LVDS).

The LMH6554 isn't quite the fastest amplifier in its class. Some are a bit faster. However, the LMH6554 has significantly less noise density (less than 1/2 x) so it may actually work better for your needs. And, who needs a lot of excessive bandwidth if it is just going to amplify up a noisy noise floor?

This amplifier can be shut down to below 1 mA, with fast startup available. The package is a compact 14-pin LLP, which enables good heat transfer at about 60°C/W. These features may be useful if you need a realistic fast amplifier. Product planning takes in almost every real-world insight! 📧

Comments invited! czar44@me.com —or:
R.A. Pease, 682 Miramar Avenue
San Francisco, CA 94112-1232

BOB PEASE obtained a BSEE from MIT in 1961 and was a Staff Scientist at National Semiconductor Corp., Santa Clara, Calif.

What's All This Leopard Stuff, Anyhow?

When I was “allowed” to “retire” from National Semiconductor on March 14, 2009, I promptly went down to the nearby Apple store to buy a MacBook. It had a new and improved operating system, OS-X (10.5.7), also known as Leopard. I was tired of fighting with Microsoft-based computers.*

I paid \$1000 cash plus tax plus a couple hundred bucks for a service contract. I took it home and it began to *just work*. I was very favorably impressed. It just worked! I could send e-mails, and I could receive them. I had heard all the good stories about Apple computers, and I believed I was through with grief.

But after a while I started finding *leette* problems. This MacBook needed to be rebooted every six or eight days because it simply stopped working, on the average—about as poor as my old Lenovo T-61. So much for Apple’s vaunted reliability.

Then I typed up a nice two-page memo in Apple’s Mail software. Just before my computer went sick-poo (that is a technical term), I clicked on “Save As Draft.” I shut the computer down and rebooted. I went to “Drafts,” and my memo was not there. That annoyed me—a lot.

I reconstructed the memo from memory. I shoved it into “Save as Draft,” and I also shoved a copy of the e-mail into the free Thunderbird e-mail application from Mozilla, which my son Ben had given me. After the next big crash, I restarted it all, and the copy in “Drafts” was gone! But the copy in Thunderbird was saved. I was very grateful.

The search begins

Somebody told me, “Well, if you do a save, it might try to ‘Save to Server,’ depending on your settings...” What the hell was that supposed to mean? No info. Never heard of that.

Apple has several kinds of search machines in Leopard including Finder and Help and Spotlight—and calling the factory guys. I searched everywhere and could not find any info on “Save to Server.” Neither my wife nor son could guess where to look.

I had bought a couple hundred bucks of books that claimed to be able to teach me everything I needed to know about this Mac. They were utterly useless. This started with *The Missing Manual* by David Pogue. Bragger.

Finally my wife got lucky and happened to find “(X) Save Drafts to Server?” I hit the X to un-check. Now it will save drafts to the hard drive. Even after I found the devious instruction path—Mail/Preferences/Accounts/Mailbox Behavior/Save Drafts to Server?—none of the search methods above could find it.



In other words, I discovered that Apple had some features that were extremely well hidden. This just confirmed what I’d suspected: that Apple continually adds many fine features into its computers, which I sorta like, but the company doesn’t like to tell you about them. It just likes to hide things, with no documentation. That, I do not like.

If I save to my hard drive, I can save an e-mail with a guy’s address and phone number and get that info back even if I am in the middle of nowhere, in my car, etc. But if it was only “saved on the server,” that’s pretty

hard to do without a connection to an actual server, eh?

One helpful expert at Apple explained that “Save to Server” does not necessarily mean it will not save if you are not connected to a server. But my experiences contradict that.

I was going down to the mall and I parked up by a San Francisco branch library, where I found a couple more books on Leopard. They all had the same deficiencies. In fact, they had largely the same wording. H’mmm. I then went down to the mall and looked at a couple more books on this topic in Borders, and they had the same deficiencies—and phrasing. H’mmm. Why am I such a suspicious old bastard?

Other gripes

Other problems turned up. In the Safari Web browser, my address line disappeared—namely, the place where you’re supposed to type your URLs. Using the instructions in Mr. Pogue’s book, I couldn’t get it back. Ben tried to help me by phone, and his advice didn’t work. Finally when he came by, he figured it out quickly, using a slightly different variation from what the books said. The books were out of date. The computer was “improved” until it didn’t work.

Similarly, I needed to look at a few pdfs, but the print was too small to read on the screen. How could I expand it? Mr. Pogue’s book had explicit advice on how to expand a pdf, but it did not work! Finally Ben came by, and in three minutes he showed me four ways to zoom in on a pdf so I could read it. What a miracle!

Similarly, if I am saving an e-mail, and then I start to type and make updates, my Mac can make some autosaves. But this function is utterly hidden and undocumented, with no explanation in Mr. Pogue’s book or any other book. If you *like* the autosave, the lack of an explanation is tolerable. But if you *don’t* like it, you should be warned so you can do a workaround and avoid it, eh?

Continued on page 95

PEASE PORRIDGE

Continued from page 96

I tried to find instructions on how to use the excellent fonts in Mail. The instructions did not work. Also, I tried to type some subscripts and superscripts. I wasted an hour only to find that this Mac can't do it. The index in Mr. Pogue's book's does not tell you anything.

I wanted to count the number of bytes in an e-mail so I would know how big it was before I sent it. I wasted two hours to find out that this Mac can't do that. I wanted to know how to block large e-mails, say, 1 to 4 or 16 Mbytes, and my son finally found an instruction to do it, but it wasn't in any book. And, I wanted to send myself a reminder in iCAL, but the instructions in Mr. Pogue's book didn't work. The instructions in *Mac OS X 10.5 Leopard* by Robin Williams didn't work either.

Mr. Pogue's book is incorrect about many such instructions. He published a book with many commands that just plain do not work. He thinks he can stonewall me with my complaints, but I am publishing them right here. He has annoyed me by trying to ignore me and pretending he had no problems.

Can a Leopard change his spots?

I finally figured it out. All of those books were constructed by an "author" who took a bunch of ideas that Apple sent out to them and turned them into a "book." I know how a lot of authors work. They print what Apple hands them on a platter, even if it is obsolete.

A computer expert at Apple assured me that Apple does not give out information that way to potential book authors. But circumstantial evidence says I am quite right about that. And these "authors" don't check to see if the instructions are still correct—which they often ain't.

I wish I could recommend a book on the MacBook that works, but I can't find one. My wife likes the Robin Williams book. But I'm convinced it is no better. The others are equally deficient and erroneous in their commands. I don't care if I am a "dummy." Mac users like me don't deserve to be treated this way.

If you want to see my complete list of more than 65 complaints about Leopard and Mr. Pogue's book, go to my page on the *Electronic Design* Web site at www.electronicdesign.com/go/BobPease.

So, what do I think Apple ought to do? I think it should spend less time on adding cute features to its computers and more effort on making sure its features and instructions are properly documented, actually do work, and are well-explained to its "authors."

What do I think Mr. Pogue and the other "authors" should do? They should check the commands and instructions they are about to publish to make sure they work before they push the start button on the printing press.

What do I think you readers ought to do? Question authority! Tell me about any features and commands that do not work in your Mac or in any computer that uses Leopard. ☹

* *P.S. Grouchy story about Microsoft comes next month....*

DAVID POGUE RESPONDS

I'm afraid that Mr. Pease is misleading your readers! First, he implies that I didn't respond to his e-mail seeking help. That's not true. His original message to me was an eyebrow-raising diatribe, filled with hostility. Here's a taste:

"You are PRINTING the same stupid CANARDS that are just UNTRUE, and INCOMPLETE, and DO NOT WORK. And they are the same old BALONEY that is published in the comparable books by other PARROTS—who are just printing what Apple told them to print. I've read other books at the library. YOU are not alone. You are just another PARROT."

Now, I routinely respond to my readers—and I did respond to Mr. Pease. I told him that if he'd like to ask his questions civilly, I'd be happy to help him out. Mr. Pease didn't reply.

As for the book, *Mac OS X: The Missing Manual* has been the #1 bestselling computer book in the country since 2007. That is, it's more popular than any individual Windows book, Photoshop book, Google book, and so on. As you can see by the 5-star reviews on Amazon, hundreds of people find the book complete, entertaining, and accurate. So what about Mr. Pease's problems?

He says he founds two errors in my book. One was a change in wording in Safari, the Mac's Web browser. ("The books were OUT OF DATE.") He doesn't say what this wording change was, but software companies do sometimes update their programs after a book like mine is published. I don't know of any solution except to update the book each time it's reprinted, which is what I do.

Second, he says, "I needed to look at a few pdfs, but the print was too small to read on the screen. How could I expand it? Mr. Pogue's book had explicit advice on how to expand a pdf, but it did not work!"

Here is precisely what my book says about enlarging a pdf: "Zoom in and out using the Command-plus and Command-minus key-strokes." That works perfectly. I don't know of any way to phrase it any more simply! (The introduction of the book even explains what is meant by "Command-plus"-type keyboard combinations!)

In any case, my invitation to help Mr. Pease personally is still on the table—if he omits the rancor and name-calling. But he can hardly expect me to devote time to his computer problems when his approach is to rage and fling insults.

—DAVID POGUE

* *Bob Pease says he has never received any e-mail or communication from Mr. Pogue, volunteering to solve computer problems.*

Comments invited! czar44@me.com —or:

R.A. Pease, 682 Miramar Avenue, San Francisco, CA 94112-1232

BOB PEASE obtained a BSEE from MIT in 1961 and was a Staff Scientist at National Semiconductor Corp., Santa Clara, Calif.

What's All This "Cheat-Sheet" Stuff, Anyhow?

My friend Noah rented a car at the Glasgow airport, a new Toyota Avenis. We were almost ready to start out, but he was suspicious as he couldn't find any emergency brake release. He drove slowly to the rental lot exit and asked, "How do I turn off the handbrake?" The guy hollered, through the heavy rain, "See the little green button by your left knee?" Reply, NO.

The guy did some pointing. There was a tiny green button, above the driver's left knee. "Push that and the handbrakes go on." (Wurra wurra...) "Now, pull on it, and the handbrakes go off." (Wurra wurra wurra.) On a flat space, this works fine, a nice lazy way to go. But on a hill in traffic, or when parked near a steep dropoff, we decided to eschew such cutesy schemes. Just use the heel-and-toe on the gas and brakes. Much more predictable. Still, there were other inobvious things in this car that we had to figure out. And it was 4 in. wider than the car we had requested.

Within two weeks, we swapped in that car and rented an Opel Zefira in Dublin. It was a more conventional car and had fewer foibles (and fewer processors), but it still had some odd things to learn. The windscreen wiper controls were sequential. You didn't push the lever up a fixed distance to turn them on. You pushed them up once for drizzle, again to run, and a third time for fast.

The computers, which were (we found out on the last day) nested among the myriad controls for the radio, wanted you to push many menu items to see certain things. At one point, it suddenly started displaying RANGE (before it would run out of gas). We were never able to turn that function on again! But eventually it turned itself on. We were finally able to turn the car in with 37 km of fuel to go. Not bad.

Cheat sheets

Cars, especially rental cars, need a cheat sheet to explain any non-standard things. If there are inscrutable functions (does "Eject" mean eject a CD, or eject a disagreeable passenger?), it can be dangerous. My wife just rented a car and couldn't find the light switch. I think it's criminal for controls as important as that to be hidden in a non-standard way, especially as you might need them! When you suddenly come to a tunnel, it may be important to know, "Where did the bastards hide the light switch?"

In some cars, you just stomp on the emergency brake to stop and stomp again to go. Once I was driving up from New York City to Rhode Island. It got dark. We swapped drivers. Soon we were doing 65 mph in the fast lane of the Connecticut Turnpike, and



my friend Leo observed that the emergency brake light was on. So he tromped on the emergency brake pedal again to turn it off.

Unfortunately, this was a car where that just puts on the brakes harder. Very soon we were doing 3 mph in the high-speed lane! Fortunately, Leo was a real sharp guy, and he fished in the dark for the release, and we got going before any crash occurred. So my friend in Glasgow was wise to ask how to turn things off.

If you know how to ask, fine. But if you don't know what you don't know, then you

can't even ask the question. I don't like that. So when you rent a car, make sure you know where to find the important functions. Use a list (such as the lists from my pretty good book, *How To Drive Into Accidents—And How Not To*).

Computer woes

This goes for computers, too. When I bought my Mac, I soon put together a list of questions that I'd need help answering. One of my colleagues said, "Just read the book." I had to explain to him that no owner's manual comes with the computer. No driver's manual. Not even a cheat sheet.

So I started making my own, which is why I have over a dozen notes taped to the inside and outside of the top cover. Apple has made the Mac so "intuitive" that for dozens of functions, you can guess what to do. But in other cases, you can't tell, and you can't even guess. You can't even hardly define what you don't know.

There's a whole cottage industry of books that should solve some of these problems for the Mac (see "*What's All This Leopard Stuff, Anyhow?*" Jan. 14, 2010, p. 96). But you often have to wallow through dozens of pages to find a simple fact. Other times, this doesn't even work.

So the next time you are including a cute feature in one of your computers, ask yourself if anybody can find it. If not, can you include (preferably on paper) an index? If not, you may be well on your way to having thousands and millions of people curse you, like some other software experts I know.

Or you might put it in a cheat sheet. [EJ](#)

Comments invited! czar44@me.com —or:

R.A. Pease, 682 Miramar Avenue
San Francisco, CA 94112-1232

BOB PEASE obtained a BSEE from MIT in 1961 and was a Staff Scientist at National Semiconductor Corp., Santa Clara, Calif.

Bob's Mailbox: What's All This Leopard Stuff, Anyway?

Bob responds to letters regarding his "What's All This Leopard Stuff, Anyway?" column.

*** Hello, James,

I read your amusing column. You are almost 70 and apparently you have just learned:

1. A lot of computer/technical stuff *doesn't work*.

*** Yet all my friends told me that the Mac was a great machine, and user-friendly. Even my wife, even my sons. If they don't know the truth, who the hell will?

2. A lot of technical books *lie about it* or keep silent.

*** Or, don't know anything...

*** When a guy has all the credentials that Pogue has, ((CLAIMS he has)) I had to try his (((MUCH worse-than-useless))) book. How was I supposed to know that he didn't know C__ P? And gave false instructions. And in this case, not just a "LOT of technical books." ALL of them. If there had been one that told the truth, I'd have bought it.

*** That's okay, wait 'til you see how I NAIL Bill Gates and Microsoft next month. They are within 1 dB of being just as rotten, just as good at lying as Apple. Plus or minus 1 dB.

*** I already knew that Microsoft was pretty bad, which is why I jumped to Apple on the strength of their good "reputation". I never expected a Mac would crash ~ weekly and eat dozens of e-mail drafts and Outbox e-mails. How the hell am I supposed to know? Now everybody knows.

I am deeply *shocked*.

*** Thanks for writing anyhow. Meanwhile, my ANALOG computers don't *lie* or refuse to work. / rap

best wishes

j.g. owen

*** Hello, Howard L.

C'mon Pease, you old goat, what are you doing futzing around with computers. Stick to Post and pencil—No. 1 soft lead is very pleasurable. You never saw the day you needed more than one decimal point anyway.

*** Cut the BALONEY, Howard. Pencil word processing does NOT make good e-mail. All I need is for my computer to NOT lose or destroy what I typed. Then I can print it or send it. Or publish it. What do YOU publish?

*** I agree that 1 or 2 decimal places is often adequate. Sometimes I do 4 or 5 or 6 or more. Don't tell me what I can do. I can do 5 or 7 or 9 decimal places in my head when I need to. Even better than my 25" slide rule.

Dave Pogue—sorry, not buying it. He may have only one horn left, but he got you dead center and if heights bother you stop flailing.

*** No, actually, I got HIM dead center. His books are full of things that don't work. Have you read any of them? The computer is full of good ideas - - - that are un-documented, and may do more harm than good. I explained how these can be fixed. READ WHAT I WROTE...

The point you need to enshrine is that a customer of average intelligence could not (no matter why) avail himself of a solution to a simple problem through your book, and upon several different occasions.

*** YOUR "POINT" is pointless and makes no sense. You don't even define which of my books you are thinking of. Would you like to try again to explain what you were driving at?

Pease, if you want suggestions, spend your time on these:

Why is it that small-time consultants/engineers cannot afford MATLAB, Agilent, Mentor, etc. CAD but they sell it to students for 39 cents?

*** Because if you are professionally more than a student, they expect you to be able to chip in big bucks, after they got you HOOKED.

*** This is like ICs—the price is set at - - what's it worth to you? - - and is quite unrelated to what the IC_COSTS_. With students - - they are just trying to get you HOOKED...

*** Myself, I am hooked on "Back-of-Envelope" SPICE.

What is the range of mismatch loss if VSWRout drives VSWRin?

*** Sorry, I don't do RF... that's somebody else's specialty.

Has "why do tubes sound better?" been settled, and why not?

**** YES. Refer to the 1985 debate between Bob Carver and a bunch of tube-oriented audio freaks. He said he could make a solid-state power amplifier that sounded THE SAME as a very good vacuum-tube amplifier; they said he couldn't. They were wrong. When he had tweaked his amplifier, the Golden-Ear guys were shocked BECAUSE they couldn't tell them apart.*

**** See at: http://en.wikipedia.org/wiki/Bob_Carver and see the 1985 story at "Amplifier Modelling". Other accounts of this can be found and documented.*

**** Maybe some tube amplifiers sound like a (pleasantly distorted) style that some people like. But, don't give me that "sound better" crap. It is dead and buried. Because tubes can't REALLY do anything that transistors can't. If you want a solid-state amplifier that sounds as CRAPPY as a tube amplifier, it can be done. And probably more reproducibly.*

Human brain takes 20 watts and the highest frequency is 3 kHz...

**** Which simply goes to show the advantages of parallel processing versus serial. A digital computer can't play quarterback for the Colts or the Vikings EITHER.*

come on people...

**** Come on yourself, Harold, stop being silly. / rap*

Howard Leveque, Maryland

**** Hello, K.K. Benner,*

Bob,

Your experience with Apple and the several absolutely worthless books to assist us stupid idiots desperately seeking help to solve the simplest problems mirrors my Apple experiences precisely. As one who has studied this phenomenon for years, Mr. Meek & Humble here, is well qualified to explain all this.

**** I'm pleased to meet you, Mr. M & H.*

You see, Bob, this is related to my published treatise of about 1959 titled "Intentional Complexification for profit"

**** How can I learn more about this? Can I see it, download it, or buy it? Get my librarian to find it?*

illustrating how many products promoted to solve these manufactured problems—i.e. identity theft, computer viruses, the sales of updated computers, etc. ad nauseam—accomplish little other than massive profits for the promoters.

It also serves to enhance the wealth of insurance firms, financial firms, credit-card solicitors, fund raisers, etc. using well-lawyered gobbledegook double-talk in their promotions and subsequent incomprehensible agreements.

**** Uh, YEAH.*

Perhaps the most classic example is the U.S. tax code providing billion-dollar fleecing the American funding of the irresponsible but politically influential.

**** I already do know all about THAT. YOU probably know all about Form 6251 and the AMT. I've written a couple columns on THAT. Available on request:*

**** Everybody says, "You can't avoid the AMT" but they are LYING. / rap*

I really enjoy your columns, keep 'em coming!

**** Thank you for your SANITY CHECK.*

**** Where can I learn more? / Best regards. / rap*

Ken Benner, Arizona

Bob,

Just got thru reading your column on "What's All This Leopard Stuff". You are a cranky old bastard!

**** Check.*

I feel that I can say that because you and I are apparently the same age. I started in semiconductors at Motorola Phoenix back in 1961. Looking forward to your column about Microsoft next month (if I'm still around).

**** It goes on the web about 23 Feb.*

Dave Richard, MA

Hi Bob. I too switched to MAC this year. I could no longer STAND windows. My wife says she hears MUCH less swearing around the house now than she used too.

**** Ahem!! (In a few months I may get to that stage.)*

My experience is largely different than yours—although I am not ENTIRELY happy with my Mac either. I have two or three things to say which I think are important:

1. Download and use FireFox as a browser instead of Safari. There are MORE users of FireFox than Safari and this is IMPORTANT for bug elimination.

**** Maybe so. But I am interested in Good Enough, and not Perfection. I use www.dogpile.com in Safari, na bad.*

2. Mail clients are troublesome always. I use the Mac Mail client with GMAIL but I use IMAP as my mail protocol (not POP). This has some important advantages for me I could explain if interested. In any case, interestingly, it was MAIL that pushed me over the edge with Microsoft and FORCED me to get this Mac. I can now use mail offline and online and all over the place—which I could not do properly with my PC.

**** I have IMAP, too, but it loses too many of my drafts and e-mails.*

3. If you are paranoid about backups like I am, use timeMachine on the Mac and also download and use CrashPlan. It is free and PRETTY easy to use. You can backup offsite to a “friend.” I have a CrashPlan backup portal in my basement that numerous people backup to.

**** If I put an e-mail draft in my Drafts, and 10 minutes later the computer crashes, Time Machine is NOT going to save or recover it.*

Zooming is easy with two fingers. That is a new feature of the new Macbooks.

**** How charming.*

**** I taped a toothpick on the left side of the sensor pad, to prevent interference from fingers.*

I like the Mac but I admit it is NOT perfect. But it boots faster, lasts longer, recovers from Standby, and shuts down faster than any PC I have ever used.

A joke: “I finally found something a PC user can do that a Mac user cannot do... That is SHUT THE F___ UP!”

**** Maybe... Thanks for writing. / rap*

K.V.

**** Hello, Ajit*

Glad to see someone openly challenge the shiek!

Just wanted to let you know that after getting tired of Windows I moved to Linux (specifically, Ubuntu) last year; which is free and very stable (good for me as the admin), has more free games (which my kids like)! My son actually went thru "Ubuntu Hacks" book from O'Reilly and most of the things actually worked!

Wonder if you've tried Linux (or are open to trying it).

**** Hi, Ajit. I have heard that Linux is very nice and simple and friendly (just as people told me about the Mac) and that the document that defines Linux is 8.5" x 11" x 85 inches thick, and that there is no man (or woman) alive that understands all of it. I don't think that's a good system for me. / rap*

Regards, Ajit



What's All This Microsoft Stuff, Anyhow?

A WISE MAN ONCE said, "Insanity is doing the same thing over and over and expecting a different result." If only that were true. I kept asking my old Lenovo laptop to do things, and when I asked again, I often got a different result, which is very annoying.

For many years, my experience with Microsoft was simple. I logged onto MS-DOS-3.06, which was adequate to let me turn on PC Write Lite from Quicksort in Seattle (now gone, alas) and do some 'processing. It never gave me much trouble.



THE PERILS OF WINDOWS

I have never used Microsoft PowerPoint, nor Word, nor Excel, though I have heard bad stories about their gross errors, user hostility, and flakiness. After I had to give up on PC Write Lite, I used a Sun Solaris workstation, which was pretty weird. Then I used Mozilla and Thunderbird for a while. They were pretty good amateurish pieces of software. But when they got buggy, I had to give up on them.

My Thunderbird e-mail program and the whole computer would lock up as "Not Responding" for 52 seconds every five or 10 minutes, making it hard to get work done. At NSC, we had several crackerjack PC repair guys. They would ask if McAfee was causing the computer to lock up, and the computer would reply "no."

But one of the experts was suspicious. When the computer said no, he didn't believe it. He checked, and sure enough, McAfee really was tying it up. We never did find out if it was the PC itself or the Microsoft operating system or the Mozilla or the McAfee to blame. Or maybe it was the allegedly corrupt contents of a file. We couldn't tell.

So, I was hoping that a fresh start in the 21st century would give me some modern and competent software. I got a little suspicious when I learned I was getting Microsoft Office Outlook 2003, but I was assured that it would give me a mature and stable system. So, I tried it.

QUIRKS IN MICROSOFT?

We finally got Outlook working on a Thursday night. It ran okay on Friday and Saturday morning. But then it decided to not let me send myself a spare copy of a memo I was sending. Repeatedly. Then it said that my e-mail address at the time, rap@galaxy.nsc.com, wasn't a valid address. On Sunday, it demanded my password, which it had not asked for previously. And when I gave it, Outlook refused to accept it. I had to wait until Monday to get this fixed. (Rebooting didn't help.)

What else? If I pushed a draft of an e-mail into save and shut the computer down, the draft often couldn't be found in the drafts file.

But it could be found in the sent file. That's not a nice thing, for a computer to send out a draft that isn't properly finished or polished.

When I hit send, the message sometimes got sent, and sometimes it didn't. Sometimes it just sat in the outbox and refused to go anywhere. I had to do a workaround, copying the text into a new e-mail in Thunderbird and sending it from there.

Using a nickname to obtain a valid e-mail address sometimes worked, and sometimes it didn't. Sometimes if I asked for "rap," it would give me rap@galaxy.nsc.com. Other times, it gave me the address for Rapolu, Kavitha with-

out showing that rap@galaxy.nsc.com was a choice. Sometimes starting an address finished up fine, and other times, it went elsewhere. Can "Ctrl k" help you finish an e-mail address? Sometimes yes, but not always.

When I type two spaces between two words, sometimes the word processor gripes because it considers that an error, and sometimes it doesn't. Sometimes when I type a dash, I get an em-dash, and sometimes an en-dash. The stupid software seems to think it can just do what it wants to do, and not what I want it to do. That's why I do most of my typing in Thunderbird, which does not have such random quirks. Outlook also has learned to go "Not Responding."

Recently, the expert at NSC told me I had to shut off various programs in a particular sequence before shutting down the computer. I asked him where it said I had to do so. He typed this advice out for me, so I could see it on paper. But even when I did follow that sequence, the computer would goof up at times.

I looked in several books to learn neat shortcuts, but the ones they showed me weren't useful. The ones I had found that were useful weren't even in the \$80 books or in any cheat sheets.

The Bill and Melinda Gates Foundation is always assuring us that it is "devoted to the idea that every person should fulfill their happiness and their potential." Yeah, but we could reach our potential a lot better if we didn't have to use such lousy, buggy software. A lot of this software is just a t--d in the pitcher of the milk of human kindness. When people ask me if I'd like to have a thousandth of the money that Bill Gates has, I reply that if I had a thousandth as many people cursing me as there are cursing him, I wouldn't consider it a fair deal. [31](#)

Comments invited! czar44@me.com —or:

R.A. Pease, 682 Miramar Avenue
San Francisco, CA 94112-1232

BOB PEASE obtained a BSEE from MIT in 1961 and was a Staff Scientist at National Semiconductor Corp., Santa Clara, Calif.



Mailbox

DEAR BOB,

That *Electronic Design* article (*What's All This Microsoft Stuff, Anyway?* March 11, p. 80) was delightful—brought a big smile to my face. I've been with AOL for 14 years, and have encountered a number of problems in that time, but consider myself lucky in that most were rather trivial. Now, McAfee, that's a different story. I hate the way it sneaks in and overpowers whatever you are doing. (Uh, yeah... /rap)

Yesterday, McAfee turned on while Retrospect was doing its daily backup of my files. Normally when another program interferes, it just slows down the operation. This time, even the time display of hours and minutes was stalled to show the time two hours earlier when the backup turned on. The computer was frozen, immovable, unreachable, and had to be reset to reboot. That kicks Retrospect into a never-start mode, and I had to intervene and "manage my scripts" today to get it onto automatic mode again. But McAfee is free, included with the AOL service, so I guess I'll keep it. ("Free," aha, but not without terrible cost. /rap)

In another room, I have an old 80386 computer running on Widows 3.1, with no connection to the Internet and no need to have an antivirus program. It's so reliable, it's wonderful—boots up in about 30 seconds. It contains two PCL-812 data acquisition cards that I use to run testing on a small consumer electronics product that I designed. It's nice to have something you can depend on. Those cards are twice as long as could be contained in any modern computer. And the computer can even read a 5.25-in. floppy disk!

Speaking of old things, did you ever have any experience with a GEDA analog machine? I can't say computer because it wasn't programmable except through patch cords. It was a Goodyear

Electronic Differential Analyzer, with about 20 high-gain amplifiers that could be configured into very respectable integrators, since they were serviced by a rotary sampling switch that looked at all the amplifiers' input terminals in sequence and fed an amplified correction signal into the rebalancing inputs to make the voltage close to zero at the inputs. It was a rotating chopper-stabilized amplifier system. There were also one or two analog multipliers included with the system for doing nonlinear stuff.

In my first job out of Cornell in 1953, I kept popping into the lab out of curiosity where the GEDA was supposed to be working, but it wasn't. That was at the General Electronics Advanced Electronics Center near the airport in Ithaca, N.Y., which was also a relic of the past. (I never saw, nor worked on, or heard much about the GEDA. /rap)

I got it working and stayed on call in case the lab needed any further assistance. Whenever the system became unstable or went out of limits where the rotary chopper couldn't handle the signals, relays were triggered that acted as some sort of crowbar on the amplifiers to prevent their damage. It sounded just like a room full of mousetraps gone crazy.

I did help them quite a bit when they needed a source of white noise to test a simulated missile guidance system for its response to noise as the missile approached its target. I set up a bank of NE-2 neon bulbs as relaxation oscillators. Some were fed from a positive voltage and the rest from a negative voltage.

The firing times were random, determined by the R-C networks' charging times. The discharge currents fed into a common small resistor for all of them, and the signal across this resistor was the noise signal fed to the amplifiers.

On a more serious note, back at my regular job there, I did obtain U.S. patent #3,899,244, along with Bill Porter for a "Frequency Diversity Radar System" or anti-jamming radar. It was classified Secret for years after issue, and even I couldn't have a copy until it was declassified.

Years after that I learned in the magazine *American Heritage of Invention and Technology* that Hedy Lamarr (the actress) had also obtained an earlier patent for a frequency diversity radio system for submarine torpedo guidance!

J. DAVID PFEIFFER

HELLO, JOHN,

That's an old story, now well known. Thanks for writing. And to hell with McAfee! RAP

Comments invited! czar44@me.com —or:

R.A. Pease, 682 Miramar Avenue
San Francisco, CA 94112-1232

BOB PEASE obtained a BSEE from MIT in 1961 and was a Staff Scientist at National Semiconductor Corp., Santa Clara, Calif.



What's All This Carrot Juice Stuff, Anyhow?

RADAR WAS ONE of the significant advantages the Allies had in World War II. The British and the Yanks made the best developed equipment and made the best use of it. So when the Luftwaffe sent in hundreds of bombers and fighters over England in 1940, they were surprised to find Spitfires and Hurricanes waiting for them. How could the Allies be so clairvoyant as to know where and when the bombers would be coming?

The Germans were often quite reasonable in guessing how the Allies would block them, but they sometimes refused to comprehend that the Allies had their plans largely figured out. Still, the Germans got suspicious that the oddly built structures of the radar sites were a major part of their problem.

THE RADAR PROBLEM

The Germans decided to smash one of these “Chain Home” radar sites, at Ventnor, on the Isle of Wight, just off the south coast of England. The Germans attacked with many bombers and a heavy fighter escort. The RAF could not defend Ventnor, and at the end of the day, it was wrecked.

After the last Germans had fled, the British “boffins” (radio experts) realized they couldn’t get the Ventnor radar up and working for the next day. This was a painful loss as the Ventnor radar was one of the farthest south, with long range, and best able to provide early warnings. The workers started doggedly to repair the wrecked wires and mechanical damage.

A few of the boffins decided to play a desperate joke. They set up one of the radio frequency tubes that had not been busted and set it to oscillating at about the right frequency. Even though it was not working as radar, it was making noise at about the right frequency. They fed it to a piece of antenna.

When the first German reconnaissance planes came over early the next morning, they detected this noise and thought the dratted Brits had gotten the radar back on the air. Nobody could figure out how they did it, but it seemed to be running.

Air Reichsmarshal Goering decided that the huge loss of men and equipment was not justifiable, since they couldn’t knock out the radar. The Germans then began to attack other targets and goals. Eventually this turned into the bombing of the London Docks, which gradually went downhill.

So when the Germans tried to knock out the radar, they really did knock it out. But a small group of British RF engineers got a noise-maker working, and the Germans couldn’t tell they were being spoofed. This may have been a significant turning point in the whole war, when the Germans were fooled by a cheap trick. And they backed away from a strategy that really was working, but those British tricksters wouldn’t admit it.



MORE SPOOFING

Near the end of 1940, when the weather was getting rotten and there were very few hours of daylight, the Luftwaffe had to concede that it could no longer run daylight raids, as it was losing too many bombers. So, the night bombing began. The Luftwaffe figured out several ways to guide its bombers to drop their bombs in about the right place with radio beams and such.

The Brits worked on several ways to fool the German bombers and force them to drop their bombs in a spoofed location. It must have scared the hell out of the cows

in the fields. But the night bombers kept on coming.

Radar technology kept improving. The Allies made several advances in miniaturization to get a simplified (yet improved) radar set small enough to work in a twin-engine “night fighter.” It was not easy, but they got them working.

The ground-based radar would guide the night fighters to within a mile behind a bomber. With a little luck, the on-board radar would then acquire the image and get them close enough to the bomber to see the red-hot exhausts, and then they could shoot the bomber down—even at night, even in clouds.

The Luftwaffe eventually figured out something was going on to cause heavier losses than expected. The Brits decided to play it very cagey. They studied the effects of carotene and carrot juice on night vision. It turned out, a little carotene was good for your night vision, but a lot was bad for night vision.

The RAF sent out some “pilots” in uniform on various wandering trips on the London subways. These guys were not qualified for flying, for various reasons, but they could play the role of fighter pilots. The Brits loaded them up on carrot juice until their skin ran YELLOW and ORANGE. Then these “pilots” would talk furtively with their friends about their new schemes for attacking night bombers. (Of course, radar was never mentioned.) They did this where Nazi spies or sympathizers on the Underground would likely notice something.

By snooping, the spies thought that the British were able to use carrot juice to see the bombers at night. Shortly, the Germans were out in the markets, buying up all the carrots in France and Germany! Eventually, the Germans did figure out about radar-equipped night fighters, but the carrot-juice ploy made sure they were fooled as long as possible. 

Comments invited! czarr44@me.com —or:

R.A. Pease, 682 Miramar Avenue
San Francisco, CA 94112-1232

BOB PEASE obtained a BSEE from MIT in 1961 and was a Staff Scientist at National Semiconductor Corp., Santa Clara, Calif.

Bob Pease to Receive Lifetime Achievement Award at ESC



April 26, 2010 12:00 AM 13
Electronic Design
Staff

Engineering veterans Bob Pease, Martin Giles and Nick Gray will be presented with lifetime achievement awards at an Embedded Systems Conference event hosted by element14, the online global community and U.S. technology store for electronic design engineers. The event is scheduled for April 28, 2010 from 5:30 pm to 8:30 pm. Engineers visiting ESC are invited to meet the honorees at the element14 LIVE event, an “after party” that will bring some of the most popular features of the website to life, such as discussions with industry experts and opportunities to trial new technologies.



(To view a video of an interview with Pease, Giles and Gray at the event, [click here.](#))

“Bob, Martin and Nick have travelled the globe for decades, sharing new product information, application insights and design knowledge with their colleagues around the world,” said Jeff Hamilton, Director of Marketing, element14. “As the leading community website for design engineers to connect, collaborate and acquire products for their designs, element14 is proud to salute them for their years of service.”

Each of the honorees has had a distinguished engineering career. MIT graduate Bob Pease has designed 26 linear ICs, holds 21 patents, has written hundreds of columns for *Electronic Design* magazine and given many lectures around the world. Nick Gray, a 30-year semiconductor veteran has authored numerous published articles about data converters and signal integrity issues and serves as an expert on element14. Martin Giles has travelled the world helping customers to design linear integrated circuits into their products and has also written many application notes and articles.

The honorees all worked together at National Semiconductor. Bob Pease and Martin Giles were part of the company’s Analog Road Show, which was started by Nick Gray and supported by him for more than a decade. This series of educational seminars was presented to customers around the world.

Registration for the event is available at <http://www.element-14.com/community/events/2507>.

Bob Pease

What's All This Absurd Filter Stuff, Anyhow?

THIS MORNING, SOME darned kid engineer (rather bright for a 15-year-old!) asked me if I could show him anywhere he could add a little narrow-band boost or cut to a circuit for an audio signal, perhaps with a Q of 4 or 5. I told him sure, I could find a cookbook circuit in any number of audio handbooks, such as the recent reprint of the old 1976 NSC Audio-Radio handbook, available at www.AudioXpress.com for about \$16.

Then he asked me if he could have this circuit with an adjustable center frequency. I mean, okay, some dynamic equalizers do many things well. But a person might want the center-frequency to be adjustable for a special case.

Oh?

"Cut that out!" I told him. "Nobody has ever seen that or done that as an adjustable-frequency filter! And it's the most silly-assed question I've seen all week!! And it's absurd and impossible..."

Then I pondered this and told him, "But, on the other hand, I just remembered that I do know how to do it. There's probably nobody else in the world who knows how to do it, but I can do it. And changing the center frequency doesn't goof up the gain or the bandwidth."

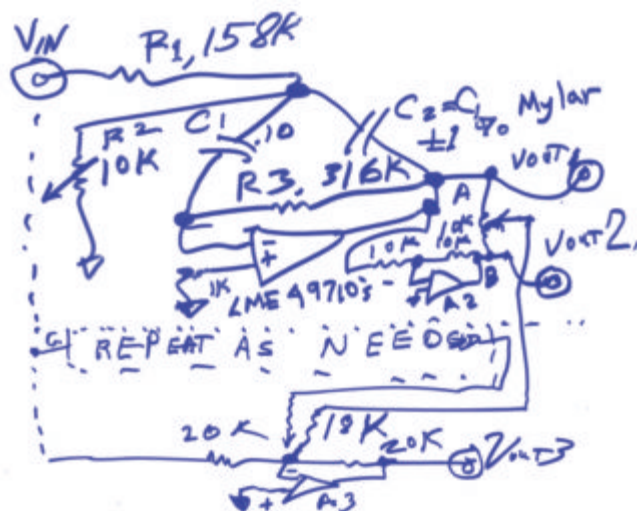

DOING THE ABSURD AND IMPOSSIBLE

Take that bandpass filter on page 237 of my orange-cover book, *Analog Circuits (World Class Designs)*, the one where trimming the F_{Center} does not goof up the gain or BW, per the figure. Set up your desired BW. Get it running. The best thing about this bandpass circuit is that the bandwidth depends only on R3 and the C's: $BW = 1/(\pi \times R3C)$.



The gain depends only on $R3/(2 \times R1)$. If $R3 = R1 \times 2$, the gain is 1. No matter what it looks like, R2 is not a trim on gain. It has no effect on gain or BW. R2 is just a trim on the center frequency. The center frequency depends fairly accurately on $1/[\sqrt{(R2 \times R3) \times (2\pi C)}]$. So, the R2 resistor has sort of a square-root effect on the center frequency. It's not really linear, but it's usable. (You could use a logarithmic pot for this if you want to.)

Note that I did say that the BW is not affected by R2. But if the center frequency changes, and the BW does not, then the Q can change somewhat. If you vary the center frequency a bare half octave, up or down, the change in Q may not be too bad. If that's okay, it's okay. If not, you might use a multipole double-pole double-throw (DPDT) switch to switch some capacitors out and others in. Be my guest. But it's worth a try, I think. It depends on what kind of band-pass filter you are trying to make. Does this circuit do the job okay? Do you need absolute precision? Put in matched polys rather than cheap mylar.

Now, take this filter's output (A) and shove it through a unity-gain inverter (A2) to make (B) = (-A). Run a pot such as 10k from A to B. Send the wiper to a 20k resistor to a summing point of a third amplifier A3. Send a suitable fraction of A through 20 or 18k to the summing point. So now the R2 that goes to ground can tweak the center frequency without goofing up the rest of the filter, maybe over a 2:1 or 3:1 frequency range. And, the new 10k pot can give you boost (+6 dB) or cut (-36 dB or more).

Not bad. I had to save this one to publish as a column. And I first wrote up that basic band-pass filter in 1971, 39 years ago! I still have a good copy of that Philbrick Applications Note, and it had no errors in it. It is still a useful bandpass filter, and it can now help you make a notch filter, which I did not realize at the time.

If you are trying to "add" a little cut (or boost) to some audio circuit frequency response, try it. It might just work well. Are you trying to notch something out? How does it sound? This is such a small, cheap, simple circuit, you could add in two tuned circuits to subtract harmonics for higher resolution.

The values shown are for 50 or 60 Hz. If you want to add a second filter for 120 or 180 Hz, as shown at Fig. C, change the R's or the C's and be my guest. [3d](#)

Comments invited! czarr44@me.com —or:

R.A. Pease, 682 Miramar Avenue
San Francisco, CA 94112-1232

BOB PEASE obtained a BSEE from MIT in 1961 and was a Staff Scientist at National Semiconductor Corp., Santa Clara, Calif.

What's All This Rocket Science Stuff, Anyhow?

SOMETIMES I AGREE that President Obama says reasonable things. But I recognize that politicians sometimes have to say things to please particular audiences, whether they make sense or not. In this case, Obama said that we and the Russians are going to decrease our nuclear warheads by about 3 dB, starting from our 5113 warheads (which had been up as high as 30,000, just several years ago).

I'm pleased the Americans and the Russians won't have so many missiles aimed and ready to fire at each other. I don't think we need that anymore. But I am uncomfortable about how we will do it. I've seen pictures of a big Russian tractor just bashing and crunching a big old missile to make sure it can't be fired. What a waste!

SOME BETTER PAYLOADS

I remember reading, a dozen odd years ago, that NASA was going to test a new rocket by putting a couple tons of sand into orbit. Maybe that was one way to run a test. Maybe they were trying to avoid sloshing. Maybe they anticipated having to throw sand on an icy hill on Mars so their rovers wouldn't skid. But I got a better idea.

To avoid sloshing, they could have sent up ice, or they could have sent up rocket fuel, or oxygen, or K rations—things that may be useful in case of an emergency. Or miscellaneous supplies and tools and equipment. In fact, the old rockets that are going to be decommissioned in the next few years could bring up any and all of those items to some parking orbit.

These payloads could be parked together in rafts so they can be easily found in the future. Park the raft over 10 or 20 miles from the main Space Station, which is not too far to go over and grab some supplies, but far enough that if it springs a leak, it won't foul up the neighborhood.

I know that an ICBM is not necessarily designed to push a heavy load into orbit. It's designed to throw a nuclear bomb as a big hook shot up into low space, at well below orbital speeds, which then comes down near a target. So it might not be able, after its payload and re-entry cone are removed, to carry a lot of weight even into low Earth orbit (LEO).

Some of the smaller rockets probably can't carry up a useful load. But some of the bigger ones can. After all, much of our older rocketry was accomplished by using old ICBMs such as the Saturn IV. Maybe the smaller rockets can just be used for pure science experiments, but the Russians have lots of medium-large rockets that can be used for this heavy lifting. This is a task for real rocket scientists, to plan which rockets can be used for what.

Even after these useful loads are put into LEO, NASA will have to send out a space taxi to drag them to a higher orbit



where they will be stable for years, or a space cowboy with a magnetic lariat to corral them.

NUKES IN SPACE

What are we going to do with the warheads? Oh, I'm sure the experts have plans for that: sell the gyros as surplus and recycle the nuclear material. Except we always hear about plans to send up a nuke to push an asteroid off course if its orbit gets too close to earth. Okay, maybe we can take a dozen of the most reliable assorted warheads, big and little, and hand them over to

the United Nations, and let them supervise putting these atomic bombs into space alongside the raft of useful materials.

Oh, heavens! Somebody is putting atomic weapons into space! Some evil group will be able to rain them down on the Earth! Terrible! What if Al Qaeda snuck up and stole a few?

We don't have to worry about that. These nuclear explosives, up in a high orbit, have no re-entry vehicles or nose cones. They couldn't survive if you sent them toward Earth. They would burn up in the atmosphere. Rather, these "bombs" will just have a light frame to couple them to a simple bare-bones rocket, with no nose cone. In fact, these bombs could be set up to be 100 feet wide in every direction so nobody could ever try to put them in a re-entry vehicle. A bomb that's 100 feet wide could never re-enter the atmosphere.

In space, bulk of that sort would do no harm. A nuclear explosive could be sent out from the raft, with a small rocket motor, at 0.05 g to get close to an asteroid and then, as required, either nudge it off course or blast the heck out of it. If a dangerous asteroid is suddenly found, we might be in a hurry to go out and blast it. Having the rocket and nuclear blaster already up in orbit will save a lot of time and energy compared to launching from Earth.

So, here's a new proposal to turn spears into plowshares. I'm not going to guarantee that I thought of it first, but I haven't seen anybody else talking sense about what to do with old missiles compared to carrying sand into space or crushing them with tractors. I have talked to a few people at NASA, and they agreed, in an offhand way, that some of these ideas might be useful. After some real rocket scientists have studied this, to estimate which old rockets could carry a useful load, we would have time to start to do this right. 

Comments invited! czar44@me.com —or:
R.A. Pease, 682 Miramar Avenue
San Francisco, CA 94112-1232

BOB PEASE obtained a BSEE from MIT in 1961 and was a Staff Scientist at National Semiconductor Corp., Santa Clara, Calif.



What's All This Smart Grid Stuff, Anyhow?



nce upon a time, in the 1940s, there were only rotary telephones. They were very slow and inefficient, using mechanical stepper switches, click-clickity-clack. AT&T recognized the need for an electronic system, so it designed the basic touchtone system we now know and love.

AT&T set up a big press conference and demonstration of the new system. A charming young lady came out to show its advantages. She sat on the stage in front of the cameras and started to give her well-rehearsed lines. She started to punch in a telephone number. She misfired. Now what? She

tried to hang up, but the system wouldn't let her redial. Apparently, nobody had considered the possibility that a person might misdial a number and have to redial.

AT&T shut everything down and apologized. A few weeks later when it had the problem fixed, it ran the press conference again, correctly. So much for smart telephone grids.

Now we have the Smart Grid, and smart meters, for gas and electricity. In California, PG&E (Pacific Gas & Electric, also known as Pigs, Greed & Extortion) has connected up to 3.3 million "smart meters," which are presumably helping people save energy and money. In fact, 99.8% of these meters work fine. Just one *leettle* problem—more than 5400 customers have had terrible problems with bad meters. They read either much too high or too low.

Whichever is the problem, PG&E sends out an estimated bill. Some of these bills are so absurd, the customers are enraged. PG&E apparently did not have any good plans to talk thoughtfully to customers, not any better than AT&T had. So gangs of outraged customers are protesting and marching on PG&E, equipped with pitchforks and torches.* Wouldn't you be grouchy if you went on a month of vacation and came home to find a \$236 bill for electricity, even though you'd turned out all the lights?

Did PG&E have no plans for the possibility that some meters might err? Who designed the meters? Who built the meters? Who ran the quality control on the meters? Who evaluated the meters after they were installed? Who planned the customer relations? Not me! Did these guys all assume that the "smart meters" *had* to work right because they were all-digital?

Do you trust the people who designed and put out these "smart meters" to run a complete "smart" power grid? I can't answer any questions. But I am qualified to ask questions.

I just hope that somebody has set up some stronger, smarter firewalls to keep foreign hackers from going in and mis-programming the grid's computers to wreck all the generators and transformers. If the Department of Defense isn't smart enough to keep all the hackers out, who is? I hope somebody is.

Will we have enough electricity to charge up all the new electric cars and plug-in hybrids at night? You can manage some parts of a shortage, and you can make incentives for people to postpone their charging. But a real shortage is a real shortage. Pretending doesn't fix that.

Since that's the limit of my wisdom on that topic, I'll shut up and sit down.

Twitter? Twitter-BARI!

I keep getting invited to join up with other people in "social" or "professional" "networks" like Linked-In, Twitter, and Facebook. They drive me nuts!

First, their software is often horrible. It won't let you reply, and it's nearly impossible to resign. When I tried to sign up on Linked-In, it refused to believe that my e-mail address is valid. After eight tries, it decided my e-mail was okay. Then it wouldn't let me reply to other people because it said their e-mail addresses weren't valid. It asks dumb questions like "Why don't you have any recommendations from MIT?" Well, I haven't been there for 49 years. Half the guys I knew are dead.

Then I get requests from people who want to sign up as my "friend." These vary from good old friends to people I may or may not have met for a minute, at a conference, years ago. I'll just do none. No more. Sorry.

Recycling?

If I buy wine in a bottle or jug, I take the glass back for recycling. Good. But sometimes I buy box wine. I don't like all box wine, but Almaden's Mountain Chablis is pretty good.

When the wine is gone, what can I do with the packaging? My wife talked me into using 3/4 of a box (lop off a corner) to put magazines in. I have groups of several magazines boxed up thusly. Not too heavy, whereas a photocopy paper box of magazines is much too heavy!

Then I had some covers for photocopy boxes, with a busted (ripped) corner. I took the other quarter of the wine box (a corner) and shoved it around the ripped cardboard, added a couple dabs of glue, and these boxes are better and stronger than new!

Now what to do with the bags? I recycle all my plastic bags. I do rinse out some wine bags and recycle them. But these bags often have excellent toughness. And nice spigots. So I use a couple for storing extra water for my bus.

These bags are rated to hold 5 liters, measure almost 10 by 10 by 4 in., and are a good grade of heavy 0.008-in. plastic (sans spigot). If you wanted to buy a bag as rugged as that, they'd soak you a buck. So, what can we do with the bags? Reuse them? For what?

* Okay, maybe I'm exaggerating about the pitchforks. ☹

Comments invited! czar44@me.com —or:
R.A. Pease, 682 Miramar Avenue
San Francisco, CA 94112-1232

BOB PEASE obtained a BSEE from MIT in 1961 and was a Staff Scientist at National Semiconductor Corp., Santa Clara, Calif.

What's All This Tsarang Stuff, Anyhow?

A FEW YEARS ago, we were trekking in northern Nepal, hiking toward Mhustang¹ and Lo Manthang. We got to the small town of Tsarang, about 30 miles north of Jomsom. In fact, this falls into the category of best afternoon solo hikes!

After we got to this small town and had lunch, I took a very short rest in my tent and then went on an afternoon solo hike to the east. The first mile was a pleasant stroll across shallow farm fields and pastures, and then the trail came to an edge. A small stream flowed down the shallow valley and cascaded down the eroded cliffs.

The trail started down, not at a scary rate, but pretty impressively steep. I thought about it and tentatively started down, and I looked up at cliffs 100 or 200 or 400 or 800 feet above me. These were not solid stone cliffs, but eroded cliffs, nearly vertical, made of stones and dry mud—and puddingstone? Clay and embedded stones. Scary!

I was a little nervous, but I thought, “If this was all going to fall down on my head, why would it choose today to do it?” I recalled a well-researched theory that if you can find rocks perched precariously on little pedestals, earthquakes must be very rare. Also, I thought, “If there had been any earthquake in the last 99 years, this would all have collapsed many years ago, so it’s not likely to happen in the next hour.”

I looked up and down and around and kept descending. There actually was a barely perceptible trail through all the loose rocks on the canyon floor. After an hour or so, as the canyon descended and widened and narrowed, repeatedly, I came out to the mouth of the canyon.

SOME NEW FRIENDS

I angled over to the right, toward the great gorge of the Khamli Gandaki (River). I have hiked and biked many miles along this great river—over 100 miles, over 90 hours. Even up here near its source, this river was impressive and scary. Probably a yard deep, rushing and raring, about 20 mph and 30 yards wide. Could I wade across it? Uh-uh. Even with two walking sticks, I could fall in and die.

Then I met up with three horsemen who had come down that same trail, about 3 p.m. They were headed east and ready to cross that great river. I do not speak much Nepali, and they didn’t exactly speak much English. But they were quite *demonstrative*. After exhausting my Nepali vocabulary, “namaste,” they did some arm-waving, and I tried to understand them.

I figured out that a fourth stray horse had followed them down the trail, and they indicated that they would like me to take it back up to the village of Tsarang (rather than have her follow them any further).² I waved my arms and agreed. Okay!

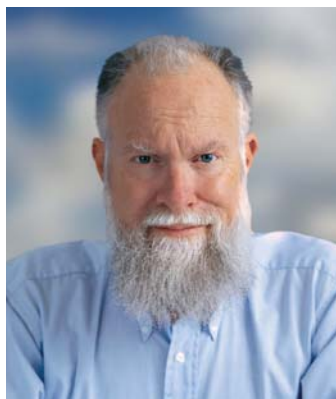

Fun challenge!! The three horsemen went across that river, I assume. (I never saw them cross. I wished I had seen how they did that.) “Ghhoraa! Jaane ukalo a Tsarang!” (“The horse is going up to the town!”)

YOU CAN LEAD A HORSE UP A HILL...

I hooked the buckle of my belt around the horse’s bridle and made a big knot in the tail of my belt for me to hold on to.³ I started to encourage and lead the horse up the hill. I did this for about 200 yards, and when I got tired I stopped pulling the horse’s head, and we stopped. After all, this is up at about 11,500 feet.

And this horse, for a few seconds, would not want to move. She just stood there. She was a fine, big white horse. If I would have gotten into a contest with her, she could have whacked me badly and dragged me back down the hill. But we got along okay. Each time, after about a minute of waiting, I was rested, and I tugged and got the horse moving. After about eight efforts, I got the horse up all the steep rockiest parts, past all the dubious cliffs, and up onto the flat area.

We walked up the last mile of the flat pastures, to Tsarang, with not much struggling. When I got there, I looked up the leader of the town. In some English, I asked this very wise young man, who was a nephew of the King of Mhustang, “What do you want to do with this fine horse that these three guys ‘gave’ me, down at the river?”

He thought for a few moments, smiled, undid the belt, and turned the horse loose. He gave her a little pat, and the horse walked off, no problem. We did not *exactly* define the owner of the horse, but I figured out that the horse would surely find her way to her owner.

Okay, going down the hill, I had a solo hike. But coming back up the hill, I had a friend. What a fine adventure in one sunny afternoon! A learning adventure. **ed**

¹ The name of this kingdom is commonly spelled “Mustang,” but it is pronounced “Mhustang” so I’ll spell it that way, to help you avoid pronouncing it like the car.

² Was the horse was a “mustang” in the way we think of a wild horse in the western U.S.? No. It was a full-sized horse, and not just a Tibetan pony. It had been well trained.

³ And what did I use to keep my pants from falling down? A spare cord from my knapsack

Comments invited! czar44@me.com —or:

R.A. Pease, 682 Miramar Avenue
San Francisco, CA 94112-1232

BOB PEASE obtained a BSEE from MIT in 1961 and was a Staff Scientist at National Semiconductor Corp., Santa Clara, Calif.



What's All This Long-Term Stability Stuff, Anyhow?

A FEW YEARS ago, a guy called up and asked me about a new NSC amplifier: “What data do you have on this op amp for long-term stability?” Without even checking, I told him that we surely did not have any such data. This was just a fairly new version of a garden-variety op amp, and it was not trying to be a technical leader in low offset or drift. So we were fairly safe in not bragging. But the customer was not satisfied.

“Why don’t you have full information on this?” I tried to explain that we can’t afford to gather this data on every little product. We can’t afford to take the data and analyze it. We also can’t afford the delays in our time-to-market. Even if we released it soon and updated the datasheet later, people would look at the first datasheet and ask the same question.

The amount of manpower, engineering power, and technician power that’s needed to do a proper study would be huge. It’s rare to find a customer who has enough serious need for that info to make it worthwhile. Usually, if we have obtained good data on previous circuits using this process, and the changes are minor, such as a minor change of layout or amount of current, or a change of output stage, we assume that the new part will look very much like previous ones.

Now, we *do* perform a little drift testing just to make sure nothing stupid is happening. For example, we’ll load up three boards, each with 30 parts from three different runs, to see if they look as good as expected. We’ll compare the data from before 1000 hours of high-temp operation versus after. We may throw one of those boards back in the ovens to get data at 2000 hours. But usually this gets boring, real fast. And when we are all done, there’s nothing to brag about. Nothing to write a glowing report about. Just “Passed.”

The customer on the phone was still grouchy. “Okay, I’ll just go over and ask some of your competitors what their long-term drifts are,” he said. So I told him, “Be my guest,” and I started to tell him the phone numbers of some of our competitors. I keep them memorized for just such occasions. But then I paused: “But then they are going to tell you the same story. They can’t afford to do precision life tests on every good circuit they bring out.”

WHEN DO WE MAKE A BIG DEAL?

When do we do a lot of testing and data-logging? When we’re using a new process or a new circuit that’s expected to provide superior performance. A new low-drift op amp? For sure. When National’s new chopper-stabilized amplifiers came out a few years ago, we ran all sorts of life tests to make sure there weren’t going to be any bad apples. And when there weren’t any bad ones, how good would the good ones be? It took a lot of nitpicking to analyze enough data to state the typical “0.006 μV per month” such as on the LMP2012.

Oh, yeah? What do you expect to see for a year or two? Our standard rule is “For a time $N \times$ longer than 1000 hours, we

expect the drift to be $n = \sqrt{N} \times$ the 1000-hour figure.” This usually makes the customer happy and/or shuts him up because (a) it is usually true, or close to true; and (b) if he wanted to get data, it’s a lot of work for him! And he doesn’t usually come back quickly. If at all. For example, for two years or 16,000 hours, $\sqrt{16} = 4$.

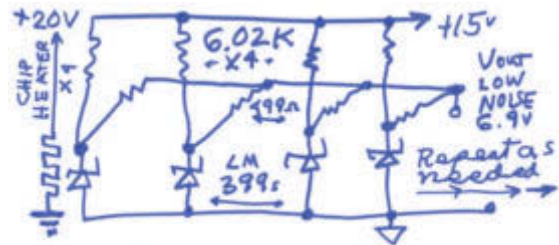

THE LM199AH SUPER-REFERENCE

When the new LM199AH came out about 38 years ago, it was designed as a new circuit using a new process to cancel out all probable causes for long-term drift. Its output tolerance was $\pm 3\%$, but the long-term stability per 1000 hours was 0.0020% typical—and that’s 20 ppm.

We put in lots of preliminary tests to screen out bad ones and then put in comparison circuits so we could use an excellent six-digit digital voltmeter (DVM) to compare several reference sources, such as ovenized standard cells, an ovenized band-gap reference, and several other fairly good zeners.

By using multiple references, we could avoid problems in case all of the devices under test (DUTs) seemed to drift at the same time. Was that caused by all the DUTs drifting? No, because the other references showed the same dip at the same time, meaning that the DVM’s reference was to blame. And that effect could be “deducted,” or at least ignored.

One day I got mad and grabbed a big double handful of these LM199AHs, soldered in a group of four, and averaged their outputs with small resistors (499 Ω). This output seemed quieter and less drift. Well, let’s do it again. Soon I had four groups of four.

I compared the averaged output from eight LM199s to the other set of eight, and that was really good! Some tests showed less than 2 μV p-p for a limited bandwidth (4 Hz?). If I had averaged all 16, the output noise would have been even smaller! Most people don’t need to make such low noise as that, but by averaging several circuits, you can get a square-root advantage. Until you run out of steam, space, and power. **31**

Comments invited! czar44@me.com —or:
R.A. Pease, 682 Miramar Avenue
San Francisco, CA 94112-1232

BOB PEASE obtained a BSEE from MIT in 1961 and was a Staff Scientist at National Semiconductor Corp., Santa Clara, Calif.



What's All This Proofreading Stuff, Anyhow?

I DECLARED MYSELF the Czar of Proofreading about 20 years ago when I found that many people were making absurd typographical errors and not correcting them or even seeing them. The new use of computers and e-mail was making it easier for everybody to type text, but harder to make it correct. Now, there ain't no secretaries, and there ain't no typing pool, and there ain't no word-processing specialists. Everybody's gotta botch up their own typing—and we sure do!

Many people agree that it's hard to do serious, accurate proofreading from a computer screen. Printing the texts on paper helps a lot. Likewise, checking a new schematic versus an old one is pretty hard, and it's nearly impossible if you don't take a pencil and scribble over every item on the old schematic right after you have compared it to the new one. It's easy to think it's right and hard to actually get everything right.

I do know how to spell Czochralski. I have found it spelled right and wrong. Spell-checkers don't even know how to spell it wrong. They certainly don't know how to spell it right. Spell-checkers are mostly a snare and delusion. There are many words that the more you look at them, the more they look right, even if they're wrong, and vice versa. That's when even I need a dictionary. And I don't always trust the dictionary.

PROOFREADING GONE AWRY

This proofreading mania largely started back 38 years ago when I was at Philbrick. Some well-intentioned guy brought in a speed-reading course by Evelyn Wood. A lot of us managers and technical guys were invited to take the course. I survived the course but found that speed-reading a book did not make me happy or educated or enlightened.

Then we took a contract on a fast analog-digital system. We had made these systems before, but there was a new, improved spec. The customer had made an innocuous little change, requiring the bandwidth for measuring noise to change from 1.0 MHz to 10 MHz. The guys who were speed-reading the contracts didn't notice the change of the decimal point.

After we noticed the change, it was too late to ask for any relief. I can assure you, it was a brutal task to get the noise down to the same level, but for a tenfold increase in bandwidth. We wasted a lot of time covering for that dumb proof-reading error. We wasted a lot more time (and money) than we ever saved by speed-reading.

Since that time, I have been reading more slowly, but enjoying it more. I don't speed-read contracts. I'm catching the errors, both typographical and philosophical. I'm catching my errors and the errors of others. My wife says I'm starting to sound like my mother.

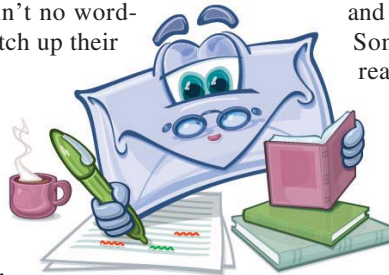

We know that handwritten text can look pretty good, but then when it is typed, certain errors pop up. Then when it is typeset, you can find even more errors! For example, some phrases that used to look okay won't look right once they're in type.

When I write a column, *Electronic Design's* editors catch some of my errors, and I catch some of theirs. After I print out a column and proofread it twice—for enjoyment and feel and for philosophy—I read it again. Sometimes I even catch errors on a fourth reading. Usually, it's a matter of my lousy, dubious word usage, not just typos.

I have proofread several books—and for good money. I proofread a couple of my own books, which is pretty hard, of course, as I'm too familiar with my own material. But I did well. And my columns rarely are published with a typo.

One time I was editing a book that had been typeset in a foreign land. I thought I was going crazy, but I found that some of the "compositors" were inserting sabotage errors into pages that had been good. That really kept me on my toes! I hollered and screamed, and I think we got all the errors out.

I've never taken a proper course on proofreading. But I've graduated from the University of Hard Knocks (UNH), and I'm pretty good at checking things. I know how to do it. I know that when it's really important to get it right, reading a text out loud nice and slowly (in teams of two or three people) can catch errors that aren't findable any other way.

How else do you explain the "Vinegar Bible," where Chapter 20 of Luke was about "The Parable of the Vinegar" rather than the "Vineyard"? Or the "Wicked Bible" where Exodus 20:14 said, "Thou shalt commit adultery"?

I know where there used to be a highway sign, "Equestrinas Prohibited." Now, is an equestrina a guy on a female horse, or a female riding a horse? I also know where to find a sign that says "Pedestrians Porhibited."

Ideally, I should have written about "wireless" topics to go along with this issue's "Wireless Everywhere" theme. I rarely run wireless signals, though I do sometimes chop out wires. One way to run some power or signals up to 100 kV+ is to use a vibrating column of air, with power transducers on the ends. Or, vibrate a teflon rod that can stand off those volts while transmitting mechanical energy.

Comments invited! czar44@me.com —or:
R.A. Pease, 682 Miramar Avenue
San Francisco, CA 94112-1232

BOB PEASE obtained a BSEE from MIT in 1961 and was a Staff Scientist at National Semiconductor Corp., Santa Clara, Calif.



What's All This Components Engineer Stuff, Anyhow?

A LONG TIME ago, about 1968, Teledyne Philbrick merged with Teledyne Nexus. We got to meet

new engineers and managers, and some of them seemed quite bright and helpful and/or thoughtful. But there was one guy who was a new kind of engineer that I hadn't met before: a components engineer. His name was Bob Thibodeau, from Nexus, and he was quiet but thoughtful and helpful.

I got to know him because I could always use a little help in choosing good new components. Also, he could help me avoid making stupid choices of bad components. He could even help me find new components that were cheaper or smaller or better than that would have taken a lot of work to research. My old boss Dave Ludwig had hired Bob for Nexus for just those reasons. And, darn, they were good reasons.

I worked with Bob for about seven years, and he was in the adjacent office. He wasn't helpful every day, after the dust settled. But every week or two, I might have a really serious need for help choosing some components, and Bob was always helpful. Or, if he didn't have an answer already figured out, he could go out and do some evaluations, and in a week or two, he could get me some good advice. Or he might get that result quickly because he knew where to ask around. And Bob said I was often helpful to him, because I had innovative ways to make measurements of components he was interested in. We did a lot of good components engineering together.

MORE RECENTLY

Recently, some guy asked on a net discussion, "How do you find out about new electronic components?" Many people had good ideas, and other engineers warned about bad ideas. If you listen to a sales rep pitch his latest products, he will show you what he is interested in selling. Unless you're interested in them too, you'll just waste your time.

Likewise, there is almost no limit to the amount of time you can waste on the Web looking for components that *are* there—not to mention, things that *aren't* there. I have found that some search engines and "filters" aren't linear. If you ask for some features or specs first, you may get to the part you want. If you ask in a different sequence, it may tell you there's no such thing! No, computers aren't always helpful.

On rare occasions, I'll talk to sales reps about a pretty good old product, and they will ask, "Are you interested in a greatly improved version? We have one coming out soon." I recently wanted info on that very new and improved product, so it was

a good fit. But if you aren't pretty careful, you can waste a lot of time on the guy's new whiz-bang products that you really have no interest in, and won't for years!

But some news releases from manufacturers or distributors tell you they can steer you to the latest, greatest, *newest* products. Yeah, and sometimes they're so new, they don't have good information, decent literature, a fair price, or any reasonable availability.

So, no, I'm generally not interested in "the latest, greatest *newest* products." I'm usually more interested in consistent, available products. Preferably from multiple sources. Note that it's not just software that can act as "vaporware."

Sometimes, a helpful sales engineer won't have what you need, but he can tell you where to look for it. I try to do that, if somebody asks me for a product I don't have. Sometimes, asking a buddy will help you find what you want. Asking

around can sometimes be helpful. However, asking for a selected part with somewhat tighter specs can sometimes get you in trouble, and I like to avoid that. Even if the yield starts out okay, it can degrade and leave you in the lurch.

| Manufacturer | Resistance In Ohms | Power (Watts) | Composition |
|---------------------------|-----------------------|---------------|--|
| AVX Corporation | 0.0 | 0.03W, 1/32W | Carbon Composition Carbon Film Metal Element Metal Film Metal Foil Thick Film Thin Film Wirewound |
| Bourns Inc. | 0.0002 | 0.05W, 1/20W | |
| Caddock Electronics Inc | 0.00025 | 0.063W, 1/16W | |
| CTS Resistor Products | 0.0003 | 0.1W, 1/10W | |
| Ohmite | 0.0005 | 0.125W, 1/8W | |
| Panasonic - ECG | 0.001 | 0.15W | |
| Riedon | 0.0015 | 0.167W, 1/6W | |
| Rohm Semiconductor | 0.002 | 0.2W, 1/5W | |
| Stackpole Electronics Inc | 0.003 | 0.25W, 1/4W | |
| Susumu | 0.00375 | 0.3W | |

NEW PROJECT, NEW NEEDS

I'm working on a new precision power project. I'll tell you more about it in a few months. But while some precision parts cost a good bit of dough, others don't. For example, a Trarlington (as I've already told you, 1.5 x a Darlington) that can pass a few milliamperes with an alpha within 1 ppm of 1.000000 costs a couple dimes. But when a similar transistor circuit has to pass 5 A, it can add up to a few bucks.

I can design some very elegant circuits to provide excellent precision, using mostly components that are 15 or 25 years old. Still, there are a few places where I need some really good parts that I couldn't buy 10 or five years ago. So, I'm doing some careful searching to get good components and to find components with plausible second sources.

Anyhow, if I had access to a few hours of a good component engineer's time, it might save me some worry, time, or grief. But this application is so simple and basic, I think I'm doing okay. More on this later. [31](#)

Comments invited! czar44@me.com —or:
R.A. Pease, 682 Miramar Avenue
San Francisco, CA 94112-1232

BOB PEASE obtained a BSEE from MIT in 1961 and was a Staff Scientist at National Semiconductor Corp., Santa Clara, Calif.



WHAT'S ALL THIS NEUTRALIZATION STUFF, ANYHOW?

HERE'S A LIMERICK FOR you:

There once was a man with a brain
Who decided to visit Fort Wayne.
He sold all the hoods
A complete bill of goods
And never went back there again.

Yeah, 40 years ago, I was called to go to Indiana to help solve a customer's business problem. It turned out to be an easy problem, so we finished up, went to lunch early, and talked about analog stuff. However, the customer did remember that he had another little problem.

The customer had a variable-gain amplifier where the photoresistor changed to provide the right gain (*Fig. 1*). But the inherent capacitance of the photoresistor was hurting the phase shift, especially when the resistance got high, up toward 2 M Ω . There was a built-in 5-pF capacitor that could not be defeated. Now what?

A Lunchtime Solution

I looked it over. Stray, fixed capacitance that is inaccessible can be tricky to cancel or counteract. H'mm. We had some new

T82AH amplifiers from Philbrick, a variation on the Amelco 805BE. Inexpensive. And it could provide flat response out to over 2 MHz.

I proposed adding the circuit of Figure 1A. This is a classical form of neutralization. I forget if we built it and measured it, but after lunch, we convinced ourselves that it would work fine. And I still had more than an hour before I had to flee to the airport.

I sat there and admired this excellent circuit. But why couldn't I get some ac positive feedback without adding a second amplifier? I thought about Figure 1B instead of 1A. I put in a little positive feedback at mid-frequencies to provide the desired phase-shift cancellation. Hey, it worked, too! And, this scheme didn't even need a variable capacitor. It could be easily trimmed with the pot.

The engineer built it up, and it worked perfectly, and it went into production just fine. It just goes to show that there are many good ways to improve the performance of an analog circuit. Some are trickier than others. They aren't all in books. Don't be afraid to experiment.

"And I never went back there again."

Recent Complaints About The "Smart Grid"

Recent gripes about "smart" power meters have centered on the observed fact that some customers' bills have increased greatly. Yes, there have been a few new energy meters that read too high (such as 2x), as if the new meter has an

error. However, if the new meter reads 2x too low (which can also happen), very few customers are complaining!

Finally, PG&E ran some tests using the old electromechanical meter, a standard smart meter, and a precision calibrated smart meter, all stacked up in series (*see "Independent Report Clears Smart Meters, Faults Utility" at www.electronicdesign.com*).

In most cases of error, the old meter was just reading much too low (due to friction?) with big scale errors (by 3x, 5x, or more). So, the customer was accustomed to paying low bills because of an old gain error and is now going to have to start paying more.

Some customers are still bleating that the new smart meters put too much electromagnetic "radiation" into the air, causing them much "danger." They haven't figured out that these new meters broadcast a few seconds per hour. If you sat on top of that meter, you wouldn't get as much "radiation" as you get from your electronic wristwatch. But skeptics are hard to convince. Sigh.

Beast regrds! (sic) / RAP

P.S. More notes on limericks later.

Comments invited! czar44@me.com —or:

R.A. Pease, 682 Miramar Avenue
San Francisco, CA 94112-1232

BOB PEASE obtained a BSEE from MIT in 1961 and was a Staff Scientist at National Semiconductor Corp., Santa Clara, Calif.

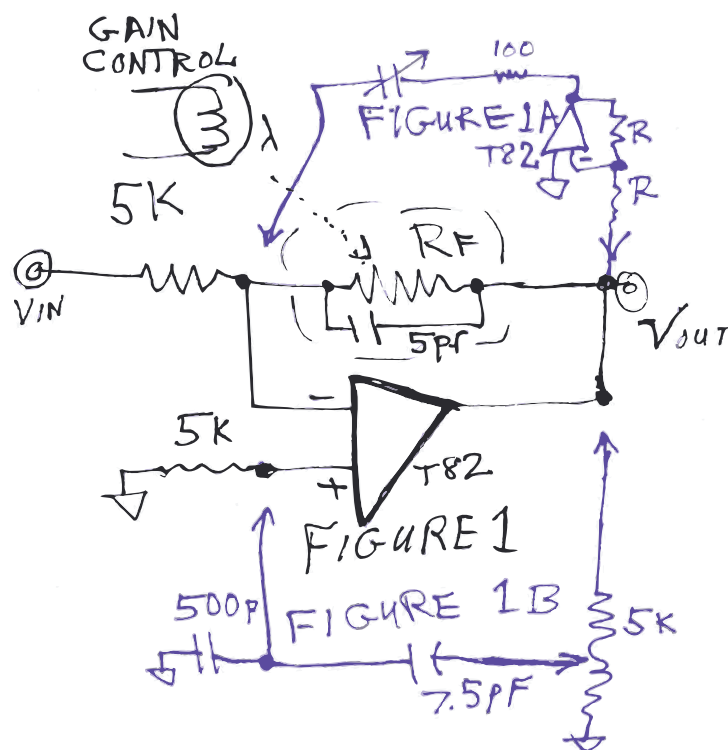



What's All This Limerick Stuff, Anyhow?

AS I RECENTLY THREATENED, here's a fun story about limericks (see "What's All This Neutralization Stuff, Anyhow?" October 7, p. 72). I've tried writing poetry and lyrics for songs, but I'm really no good at it. Part of the problem is my memory for old music from 40, 50, and 60 years ago is so good that I can't do any new music because I remember old stuff too well.

However, I seem to be able to cobble up fun rhymes in the limerick form. I was driving from Denver to Boston, about 40 years ago, and you know how boring I-80 can be. I just happened to see the name of a town that suggested a limerick. So I made up one—and another—and another.

Since towns and exits pop up every five or 10 miles on the interstate, that was just enough spacing for me to concoct a limerick for every town. It was awful silly, but it did help pass the time. **ALL THE WAY TO BOSTON!** My wife wrote down some of the best ones and some of the worst ones. Here's the best one that I still remember:

There was a young man from Chicago
Who went to see *Dr. Zhivago*.
He was such a Prude,
He considered it Lewd,
And decided to call an Embargo.

And if that's one of the better ones, you don't want to see the worse ones.

Back 15 years ago, I was having some debates with the supporters of Fuzzy Logic. Various readers had written some poems about Fuzzy. Finally one night I started to write a whole *string* of about 15 limericks. I typed them up in all caps and faxed them to Fuzzy Logic supporter Camerone Welch. Some of them were pretty good. Here's one:

"On an elevator you may perch;
Only Fuzzy can prevent a lurch?"
—Such egregious claim
May yet Pease inflame,
And for refuge, you'll hide in a Church.

SETTLING IN TO LIMERICK

I was riding in the passenger seat of our rented car as we drove through Limerick, Ireland, last year. As we came up at about 15 mph to a railroad crossing, I looked back on the right to see if anything interesting (such as a train) was on the tracks. Nope.

I immediately snapped my head around to the left to see if anything was coming up (or at least worth looking at). There wasn't much there either. But I was surprised that I had turned my head almost 180° in about a fifth of a second, and it settled

to a stop pretty well, so I could easily see what the tracks looked like. Wow. I didn't know my neck could do that!

I'm not arguing that my head SETTLED perfectly, but it slewed well enough that my eyes could take up the slack and focus on the rails with full resolution. My neck must have settled to well within 2° or 4° so my eyes could take up the rest of the small motion, the fine focus.

Measuring settling time to high precision has been a challenge for many years. I wrote a good research story for *The New Lightning Empiricist* about 40 years ago. Of course, it's a little outdated, but at the time, it was a good start.

I wrote about the general principles of how to avoid stupid errors from overdrive, like how nice little Schottky diodes don't necessarily just turn off when brought to 0 V. They may have tails of current that bleed out at low levels.

Old Tom Edison knew that to make a movie *camera* and a movie *projector*, he needed to get the film to stop and settle very quickly and stably. Of course, he cheated. He didn't just servo the film to a stop, he CLAMPED it to a stop in a few milliseconds. Pretty ingenious.

BACK TO WORK

Settling, and the instrumentation of settling, is a challenging business. How do we prove that it's done right? You need a calibrator or "lie detector" to put in a signal that must be admitted to stop and settle fast. And that's not dead easy. Even mercury-wetted relays aren't perfect. But those are some of the techniques we have to use. What did Jim Williams just write? Two app notes at www.linear.com, AN120 and AN128, describe settling measurements to 0.1% in 2 ns.

Back in 1972, I designed a monolithic bit switch per U.S. Patent 3,995,304. It worked because the bits and current sources were all common-centroid. They rejected all kinds of gradients. And, the PNPs that set up the current sources never turned off, but the currents were just steered to ground, or to a summing point. They didn't have a lot of thermal tails.

I was trying to brag about what a brilliant invention this was, and I realized I had never measured this settling. Was it down below the 14- or 16-bit level? Sure, but how about 18? MAN! I tried to guess how good it was—somewhere south of 16 bits?

If I could find one of these old bit switches, how would I measure its settling and its thermal tails? I soon got discouraged and quit planning that test. But if I had to, I could measure the settling a lot better than my neck did in Limerick. 

Comments invited! czar44@me.com —or:
R.A. Pease, 682 Miramar Avenue
San Francisco, CA 94112-1232

BOB PEASE obtained a BSEE from MIT in 1961 and was a Staff Scientist at National Semiconductor Corp., Santa Clara, Calif.



What's All This Map Stuff, Anyhow?

AFTER THE HORRIFIC gasline explosion in San Bruno, Calif., a newspaper headline said “Maps Needed for First Responders.” Well, there’s an understatement!

Lots of people need maps, not just firemen. I sure do. I save new maps and old maps. When I was a kid, I always let my fingers do the walking through the whole desk drawer full of my father’s maps—some gas-station maps (remember when they were free?) and a bunch of mediocre ALA map books.

These days I have a couple of file cabinets full of highway maps (mostly old) for various states and a couple inches of stacks of United States Geological Survey (USGS) topo sheets—some for the eastern U.S., and some for the west. I love their detail.

When I was about 11, I saved up my pennies to buy a 10-cent quad of my town, Broad Brook, Conn. When it was time to buy, I was crestfallen that the price had gone up to 15 cents. I had to wait and save more pennies. Now the darned price is up to \$8. Maps are better and cheaper than ever, but a dollar bill ain’t worth a lot.

I also love the British “Ordnance Survey Maps.” I have a few dozen, very good for hikers. And I finally got an excellent map of Table Mountain in Capetown, South Africa. That explained why I didn’t exactly get lost when I hiked up there (with no map), but I didn’t exactly get where I wanted to go.

I also have about a desk-drawer’s worth of good road maps for Europe, foreign countries, and cities. And a similar amount of trekking maps for Nepal. When I have a question (what’s the name of the tiny settlement west of Dughla, and what’s its elevation?), they’re handy.

Yes, I love maps. There are so many things you can do with maps, starting with raw inspiration, and continuing on into actual trip planning and guidance. Sometimes you can plan cross-country hikes. Flights of fantasy...

ALL IN THE FAMILY

My son Benjamin is a cartographer. He ain’t going to get rich soon, but he’s breaking even, and his maps are very handsome, such as his four hiking maps for the Marin County/San Francisco/Santa Cruz area. Check them out at Pease Press Maps (www.peasepress.com). His maps have excellent, useful, and educational notes. His maps also make a good friend.

Now, I’m a real fan of real maps. But I must tolerate, and use, some of the Web-access (Mapquest) maps. I don’t like the

way they leave out things they don’t think you need. But they are sometimes useful. Except when they feed you big errors.

I remember walking along MoPac Expressway in Austin, Texas, right where Mapquest told me to find National Instruments. I knew there was some absurd error, and of course, the map was off by more than a mile. Many people tell me that Google Maps also often makes similar foolish errors.

The other problem is that if a computer map tells you to go to the corner of, say, El Camino and Lawrence, it might take 20 minutes to find which of the four corners, and where, really. You almost need GPS for that, to scout your way through four malls. Or phone ahead.

Benjamin showed me an excellent Web site where we can see topo sheets of just about anywhere in the U.S. and zoom in on the details. I love it even though you can’t print them out. You can print out small scraps, using Printscreen. (Details on request.) I haven’t figured out how to pay for a map.

Go to <http://mapper.acme.com> and request a place you know. Then you can zoom out and in and drag the map around. I often just start in Connecticut, and zoom way out, and fly around and zoom in where I want to be. I check out

places where I have gone, many years ago.

“Olim Juvabit Meminisse”—someday it will be pleasant to recall. Well, it is. I have “let my fingers do the walking” from Moffat Tunnel to Grand Junction, Colo., along the Denver & Rio Grande Western Railroad. And from Kennecott to Chitina to Cordova, Alaska, along its 200-mile abandoned railway.

A similar site, www.topo.com, is pretty good. Can it sell me a map? There’s a similar site for the Ordnance Survey Maps in England: <http://leisure.ordnancesurvey.co.uk/>. You can see maps and/or buy maps there.

After I’ve found an area I’m really interested in, I may print a small scrap, and/or I may buy a map from the USGS map store, which stocks most of the far western U.S. at \$8 per map. That is just 1 mile off Bayshore (US 101) at the Willow Road exit. Its address is 345 Middlefield Road, and it’s open from 8:30 a.m. to 4 p.m. ☐

Comments invited! Beast rgrds. czar44@me.com —or:
R.A. Pease, 682 Miramar Avenue
San Francisco, CA 94112-1232

BOB PEASE obtained a BSEE from MIT in 1961 and was a Staff Scientist at National Semiconductor Corp., Santa Clara, Calif.

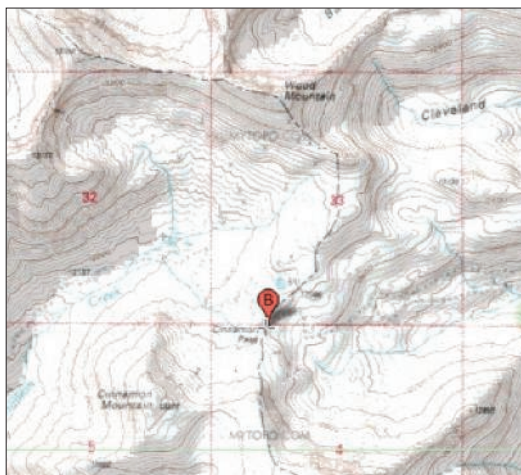

Bob's Mailbox

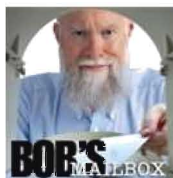

November 18, 2010 10:05 AM
Electronic Design
Bob Pease

Hi Bob,

My friend was asking me about overload recovery in op amps, and all I could tell him was to avoid those older op amps that lock up on overload. **(Yet these are not necessarily useless. The scheme listed below will let one of them work okay. /rap)**. I looked in Herpy **(What or who is Herpy? Never heard of her. /rap)** and I looked at a lot of datasheets, and I never saw any reference to how quickly op amps can recover from the output stage hitting the rail (or the input stage hitting the rail) and what happens when they do. So, I figured I would ask the op-amp guru.

Scott Dorsey

Hi Scott,

I wrote a very good story about this about 30 years ago. It relied mainly on feedback zener bounds. I wonder if I can find a copy. It is very rare for an op amp to be characterized in any way for over-drive recovery. I think ComLinear had one or two, long out of production.

Assuming you have a decent big power supply, like ± 15 V dc, you can put in zener diode clamps to stop the output around 11 V, yet keep full accuracy to ± 9 V. What functions are you trying to do? Fast linear amplifiers? Integrators? There is generally no simple solution with fast performance to please everybody. How fast do you need recovery? I can't make everybody happy.

Here's a hack. Call the summing point a, another point b, another point c, another point d. Put in a 9.1-V zener diode from VOUT to d and another zener opposing from c to d. Put a 2N3904's VBE from c to b and another from b to a. Put another 2N3904's VBE from a to b and another from b to c. And when I say "VBE," I mean base and collector tied together, versus the emitter.

Put 2k from c to ground and 2k from b to ground. When the output is swinging ± 9 V, there will be no leakage. When it hits 12 V, the clamp will begin to work. There are many variations. How's that make you smile? That's what I told you back in 1979. I can't solve every problem, but I can solve almost any one problem.

**Beast regrds,
rap**

Hi Bob,

I had to come up with a simulation of a metal oxide varistor (MOV) for some voltage surge requirements. I design high-power sonar amplifiers, and ship power systems have surge voltages that our amplifiers must withstand.

I have been using MOVs for about 40 years, but I never tried to model their voltage and current relationship. A new +50% voltage surge for 2 seconds spec made me calculate the extra dissipation. I used a ruler to measure and calculate the slope of the voltage-versus-current graph from Panasonic:

www.panasonic.com/industrial/electronic-components/parametric-search.aspx?src=/www-ctlg/ctlg/qAWA0000_AM.html

The fourth page has the V-versus-I graphs. I was amazed at how large the exponent was. I looked at the other MOV curves and decided that the ERZV20D271 had the flattest voltage curve. From 1 mA to 1 A, the voltage increases from 308 V to 360 V. That curve can be described as $I = (V/360)^{48.5}$. The voltage ratio is raised to the 48.5 power! I was only interested in the 1-mA to 1-A region.

(That is a little wild! That is a voltage ratio of 1.17:1. A silicon transistor can easily go from 520 mV of VBE (at 1 mA) to 700mV (at 1 A) , and then when it warms up, to 660 mV. But that is only a voltage ratio of 1.27:1. However, silicon zener diodes can easily have a voltage ratio better than 1.07, for a 1000:1 ratio of currents. So while it's not truly exponential, zeners can have a very sharp knee. When does a knee become an exponential curve? Heck, I dunno. /rap)

I have never seen an exponential power that large. The largest I knew of before was the failure rate of incandescent lamps increasing as the 12th power of the voltage. I should have suspected something unusual from a graph that extends 11 orders of magnitude on the horizontal axis, but only two on the vertical axis. Do you know of any other "big exponent" phenomena?

(Well, every day, silicon transistors do amazing things, but their exponent isn't as high as 48.5. Hey hey! Go to Antarctica. At -55°C , a silicon transistor has improved gm, only 132 mV per three decades. So the instantaneous delta VBE will be 132 mV, and after you allow a little time for warmup, the ratio of VBEs will be very close to 1.17:1. So, a cold transistor has just about the same curve as the MOV you saw. The exponential will be surprisingly close to 48. /rap)

By the way, our MOV easily handled the surge voltage.

Mike Fry

Hi Mike,

Very good. I may be using some MOVs soon. And sorry for the delay. I couldn't reply to your math until I had my slide rule and some paper and pencil.

**Beast regrds,
rap**

Hello,

I hate to bug you, but I am writing this in desperation and as a last resort. I am a relatively new EE student and have purchased *Troubleshooting Analog Circuits* to go along with the troubleshooting class I'm taking. I love the book, but as you know, it no longer comes with the CD. I have searched everywhere for an older edition of the book, but just can't track down a copy with the CD.

(Butterworths only printed about 1000 copies of the book with the CD. When they finally sold out, they decided to print no more with the CD. I don't have a copy of the CD. I never looked at the CD. /rap)

Do you know of any way to get a copy of the CD, or at least access to the sample circuits that it contains?

(I think the sample circuits on that CD are just exactly the circuits in the book. I never looked at them. I know how to analyze any of those circuits without any computer help or Spice. So, I would never think of analyzing them with any computer analysis.

Note that some of the circuits in the book use features of diodes or transistors that do not come supported by any device makers. Look at the 1N4148/1N914s that turn on late. Nobody has a model for that. Most engineers have no idea that that could happen. In fact, if you have a bag of 1N914s, some may remember how to turn on, and some may not. Computer analysis is going to be less than useless for analyzing this. Look at the 4N28 driving a 2N3904.

Look at the 4N28 driving a 2N3904. Can computer models of these match my observed response? Note that the range of 4N28s goes from high gain to LOW- and High speed to LOW-. You'll never see any 4N28's that look like each other, so, how can you ask a computer model to look consistent? /rap)

I guess I should also mention that I am using Multisim 10.0 and 11.0, so I'm not even certain that the CD is even compatible. If not, is that the reason the CD is no longer included? In any event, I would really appreciate any assistance you can offer.

Michael Baseman

Hi Michael,

The CD is no longer available, as near as I can tell. It has been unavailable for the last six or eight years. You're better off without it. There is nothing it can do that you can't do better yourself.

You want help? Very simple. Here is my advice: take any circuit you are interested in, and type it or enter it into your favorite Spice engine. If that is what you want, that is how easy it is to get it.

Let me observe that just in case Spice does not like to do good analysis, well, I never said it did. I never ran any of the electronic simulation studies. That was left as an exercise for the reader. I've always warned you that Spice often tells any kind of untruths about circuits. So whatever Spice tells you, take it with a grain of salt.

**Beast regrds.
rap**

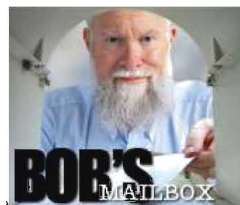

Bob's Mailbox: Negative Voltage, Feeding Dual Channels, And The Mysterious 1N430

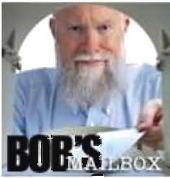

December 09, 2010 08:56 AM
Electronic Design
Bob Pease

Dear Bob,

I remember a discussion you had years ago about a technique to generate a small negative voltage from a transistor. It had to do with something about reverse-biasing one of the junctions and photons were generated and reabsorbed, generating a negative voltage on one of the pins. Do you have information on this?

Damian Bonicatto

Hi Damian,

Yeah, but there ain't much current gain—like about 0.03%. You might do a bit better with a 4N28. If you feed 6 mA through 1k into the emitter of an NPN, which is zenering into the base, which is GROUNDED, the collector will go to -0.3 V or so. But with not much current, maybe a couple microamps? A 4N28 could do better.

**Best wishes.
rap**

Hi Bob,

I would like to feed two channels of an analog-to-digital converter (ADC) with the same signal, but with one channel, say, 20 dB hotter. The input stage should be very quiet and still able to handle line-level signals so I can use low-level microphone signals or line-level signals as source (in other words, a gain-ranging analog-to-digital stage). The problem is that the input stage has to perform a gain, but at the same time must not overload the ADC.

(Oh? It seems to me that you don't care if the larger signal distorts. You just want to ignore it and not look at it. That's much easier than doing analog or digital selectors. Or limiters or clamps or clippers. Some of the statements I have read indicate that you want to look at the larger of two signals, but if it gets too big, you want to look at the smaller one. But it's not nearly as simple as that. /rap)

This has been done before, as there have been quite a few gain-ranging designs on the market for a while. But I think that those designs have always been crossfading between the converter channels, i.e., they have allowed some time for the overdriven stage to recover. I'm wondering whether it is possible to reduce the recovery time to well below a sample (at 192 kHz, that would be some 5 μ s), so I could think about other ways to use the two converter channels.

Stephan Flock

Hello to Stephan,

Okay, if I understood this, I think this would turn into a huge multilevel awareness problem. Let's presume that you have one signal, which may be small or big. It can be buffered and sent to one low-gain preamp and one high-gain preamp.

If the signal is large, the output of the high-gain preamp will get too big and will distort. You don't give a darn if it distorts. You just want to disconnect it. You don't want to look at it. That is a fine theory. But there's still nothing easy about it.

If the signal "gets bigger," you would like to detect that and switch over to the smaller signal. That sounds easy. But you're going to have to invent some criteria to decide what is *big*.

Let's say a nominal audio signal (200 Hz to 5 kHz) is fed to two preamps: one with $G = 2$ and one with $G = 20$. If the volume gradually grows until distortion will soon start, you can shift quickly to the low-gain preamp. But you have to decide what is *too big*.

What if the signal is a 30-Hz or 100-Hz sine wave? For several milliseconds, there seems to be no signal, and then a cycle comes and it becomes a big signal. And what if you have music, where there's a clash of sound, and then a low level of music? How in the name of God are you going to decide what is real?

This is a classical problem that every AVC amplifier in the world, for 90 years, has tried to solve, and everything is a compromise. AVC amplifiers usually have a "fast attack, slow decay." The circuit has to look at typical signals and gradually crank the gain up (or quickly turn the gain down) to avoid excess distortion.

You want to do this quickly and nimbly as you switch between the low-gain preamp and the high-gain one, and you want the ADC's output to be re-scaled ~ very quickly to compensate for the change of analog gain. And no glitches or clicks, eh? Don't bet on it.

So let's say you invent 10 or 100 test signals. You want the detector/gain system to do the right thing, and I can assure you it won't be easy to make a system that does the right thing.

What if one of these test signals is just a family of slowly changing sines? Of various sizes and frequencies? That part is probably easy. What if it's a family of sines whose amplitudes change suddenly? Much harder. What if you have low-frequency sines, where the spaces between half-cycles is like dead time?

Now, turn on your radio. Record samples of 50 kinds of music and 50 kinds of plain speech, like news reporters and talk shows. They're notoriously hard to handle because the dead space between phrases varies all over the place.

Can you find any system that will do what you want for most of these samples? Make the controller as easy as possible for you to manipulate. You'll need all the help you can get. I think that even starting to define "do what you want" is going to be brutally difficult.

What if you had 10 modes of operation? One mode could be symphonic music, where the volume usually changes in believable ways. But there will still be cymbal clashes and loud transients.

Sound engineers have not gone out of work and starved to death because AVC systems do so well. The good ones are in demand because there's no such thing as a really good AVC system. Am I wrong? Good sound engineers are wise enough to anticipate things coming.

If you're thinking of doing audio recording, you can record both channels and decide later what is "big." But if you want to do this in real time, it's not easy at all.

One of the modes could be "talk-show mode" so the spaces between phrases can be tolerated without the gain growing or leaping to high values. That's easy to wish for, but not easy to do well. Can you imagine a "record-the-rock-band" mode? A mode that would be agreeable to more than half the rock bands in the world? And would sound ~ good? I can't.

If I understand your wish, then changing the analog gain and simultaneously changing the digital gain is the easiest part of problem. Deciding what you wish, and detecting signals that can be detected to see if they fit "what you wish" sounds like, is at least a half a lifetime's work—or many years of frustration until you give up! Which will you do?

Best wishes.
rap

Dear Bob,

I have been following your *Electronic Design* columns for decades now and hope you have some information on an obsolete device. Recently, I found several 1N430 and 1N430A devices: temperature-compensated zener diodes in a large metal package (comparable to a 6AK5 tube in size).

The only data I can find online is the basic spec: 8.4 V at 10 mA, with different temperature coefficients per suffix. Can you suggest a source for further information on these quaint devices?

I believe they were developed for critical military applications, but I vaguely remember a column of yours about Dr. Julie where he had suspicions about the stability of references used in inertial navigation computers.

Thanking you in advance for any information,

Timothy R. Fox

Hello, Tim Fox,

One company wanted to sell 'em for \$77 to \$90. 4-STAR Electronics claims it has 1100 of them, so maybe they aren't quite as rare and valuable as \$77 would indicate. I am sure they were medium-crappy for things like hysteresis and long-term stability. You could aim for Minsk and hit Pinsk. I agree, the datasheet info is very thin. I can't find a decent one, either. Sorry, they were before my time. I have no source of info.

Best wishes.
rap

Dear Bob,

Thanks for your quick response. In graduate school (mid-1970's), I scrounged a Julie zener-diode module (1-inch ice cube with nine-pin tube base) with matching resistor that we put in a small temperature chamber and had excellent results (monitored by a Fluke differential voltmeter). **(Well, I know a lot of circuits that give excellent results if you put them in a (constant) temp chamber! /rap)** I only paid a few dollars each from Alltronics, who are now out of stock.

Tim

Hi Tim,

Yeah, that's how it goes. I pulled a good ref-grade zener out of a Minuteman II, something like a selected 1N825. I ran it for months and it never held 50 ppm worth CRAP. There goes Pinsk.

rap

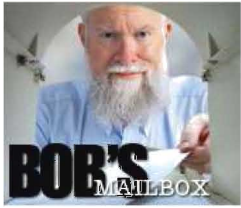



What's All This Midway Stuff, Anyhow?

THE JAPANESE NAVY'S Dec. 7, 1941, sneak attack on Pearl Harbor sank or wrecked a big fraction of

the U.S. Navy. But it failed in two significant areas.

First, it didn't sink or damage any of the American aircraft carriers. And second, it didn't flame up the large gasoline and oil reserves in Hawaii. Japan neglected to set fire to the big oil tanks up on the hillsides over Pearl Harbor. H'mmm.

In early 1942, the Japanese Navy was on a roll, after Pearl Harbor and many other strong successes. It was headed for Midway to smash it, and we were headed there to foil Japan, not having much of an idea what we'd actually do.

But we *had* broken the Japanese JN-25 naval codes, and we knew almost as much about their battle plans as they did—and they had no idea what we were doing. Or where we were. (We were tiptoeing in from the direction of Pearl Harbor.)

As the battle began to engage, our three carriers were preparing to attack Japan's four carriers. Our long-range scouts started to make contact. The Japanese carriers sent in, from the northwest, some heavy raids on the ground forces in Midway and went back to re-arm for a second attack. No surprise.

We sent in some torpedo bombers and bracketed the Japanese carriers, using bombers similar to the one that G.H.W. Bush flew, except all of our bombers were shot down, and the one last torpedo failed to detonate. Scratch *that* attack. Ouch.

Japan was getting ready to smash the U.S. carriers. Everything was ready, but the planes that were being re-armed to attack the island had to re-re-arm to attack the U.S. carriers.

And then? It was like the cavalry to the rescue. In came a dozen Dauntless dive bombers, and they attacked and lit Japanese carriers on fire, gas and bombs on their decks, burning and exploding everywhere. This story is well known. Some of the carriers took hours to sink, or scuttle, but there was no question of the result. Japan lost a *lot*. Almost everything.

What is not well known? The Japanese carriers did have radar, but it wasn't much good. The Imperial Navy knew how to do many things well, though, with or without radar.

But the Japanese forgot to put up close, medium, and wide patrol planes. They coulda, and they shoulda, but they didn't. And that was their doom. When our SBD-3 dive-bombers showed up, unmolested, with no warning, they had a clean shot, and they took their shots, and the carriers went up in flames—and then, down—and the admirals with them.

And also many of their pretty good planes, and their better pilots, and many skilled seamen—enough to man four aircraft carriers. The Imperial Navy had to quarantine the survivors to prevent this horrible story from getting back to Japan.

Who screwed up and forgot to send out the patrol planes—the pickets? Was it bad planning? I don't know, but it was a serious error, and it hastened the end of the war by at least a year. I'd hate to be the Japanese officer who neglected to send

out patrol planes. Was his attempt to send out those scout planes overruled by officers who wanted to just get the next attack going? Who knows? They're all dead.

As for Admiral Isoroku Yamamoto, the architect of the attack on Pearl Harbor, did he go down with the carriers? Nope. He was back on his battleship Yamato, miles away. Very unhappy. Fit to be tied.

GET YAMAMOTO!

In early 1943, the U.S. Navy decoded a message that Yamamoto was going to make a ceremonial visit to an air base on Ballalae near Bougainville. Now this was at the extreme range of our longest-legged planes, P-38s with wing tanks.

But we knew that the admiral was very punctual, so we set up a rendezvous with his planes. The P-38s showed up. Two Bettys came along and were attacked, and Yamamoto went down in flames, April 18, 1943. The U.S. Navy ran P-38 patrols out there for many days so the Japanese would not likely guess we had broken their codes.

LUCKY LINDY TO THE RESCUE

How did we know those P-38's could get there and back with no losses? Captain Charles Lindbergh took a P-38 on a routine four-hour patrol, early in the war. When he didn't come back after four and a half hours, everybody was scared that we'd lost him. After five hours, they gave him up for dead.

At $t = 5:40$, Lindbergh came in to land, coughing and with a dead stick. He had figured out how to lean out the engines and increase the pitch and stretch out the P-38's cruise capability. H'mmm. Valuable Mr. Lindbergh.

MANZANAR

In early 1942, President Roosevelt's administration sent 110,000 loyal Japanese-American citizens to detention camps at Manzanar and other very difficult inland places far from the Pacific Ocean. Why? Because we thought they were disloyal? Well, it was a rotten thing we did to them.

But as we had broken the Japanese Naval Code and their diplomatic codes, we knew there was a small number of Japanese working as spies or agents of Japan. If we would have arrested *only* the bad guys, the Japanese would have changed their codes, and this would have severely harmed our war effort. So, the U.S. military took extreme efforts to avoid any clue that we'd broken the codes. Got the picture? [3d](#)

Comments invited! Beast regrds. czar44@me.com —or:
R.A. Pease, 682 Miramar Avenue
San Francisco, CA 94112-1232

BOB PEASE obtained a BSEE from MIT in 1961 and was a Staff Scientist at National Semiconductor Corp., Santa Clara, Calif.

More Midway Stuff



December 28, 2010 10:54 AM
Electronic Design
Bob Pease

After my column on the Battle of Midway, one of my readers questioned my implication that Charles Lindbergh's very good experiments were applicable to helping the P-38 long-range attack on Admiral M. Yamamoto. I was wrong. He was correct. Lindbergh's service in the Pacific started many months after the Yamamoto interception. Thanks for correcting my fluff!

Note that any plane trying to achieve maximum range will use slightly different mixtures and pitch than for maximum patrol time. To attack Yamamoto, the P-38s flew at wave-top height. This also helped them avoid detection. But any plane flying at such low levels cannot do a proper patrol and watch for enemy danger in the far distance.

rap

Dear RAP,

I enjoyed reading your column about Midway. I am a history buff, and I am always looking for the unusual situations that make victory or defeat in a battle. **(Well, there certainly were enough of those at Midway! /rap)** I have a few questions relating to this famous battle. Admiral Spuance sent in the torpedo bombers first, which were wiped out. Only one of our pilots survived.

A very short while later, our dive bombers arrived and had no opposition from the Japanese zeroes, because they were down near the surface to drive off the torpedo bombers. Did Admiral Spruance consciously send in the torpedo bombers first, just to open up the way for the dive bombers?

(I don't recall ever reading about that, yes or no. You'll have to read better books than I have. I think there are a couple full-detail books. But while the Japanese usually did a lot of things right, it was poor discipline and bad planning to not keep some of the Zeroes held back, up high... even for watching! /rap)

Why did the Japanese commander order a rearming of his planes? **(The Japanese wanted to make their attack perfect and well-coordinated. This you can read even on Wikipedia. /rap)** They could have gone off to attack the American carriers with the anti-ground bombs they were carrying .

(True, but the Japanese admirals liked to have a perfectly organized attack. "The Perfect is the enemy of the Good." I have read that, several times, when we discovered a Japanese fleet, we hit them with what we could to get the best early surprise. Our guys often decided to *not* wait until their attack was perfect. "Hit 'em with what you got, and don't wait for a perfectly coordinated attack. Hit 'em early and knock them off balance." /rap)

They still could have done a lot of damage even with less than optimum ordnance. **(Yup. Those Japanese pilots (in those days) were very good attackers. But by screwing up, they soon ran out of their best pilots. /rap)** Thank God the Japanese made that grave error.

Regards,
John S.

Hi John S.,

Uh, yes! If they had made any proper attack on our carriers, that would have been just one hell of a fight.

Continue on next page

I also heard that some of the Zeroes were roughly prepared to take off from the carriers, with the engines revving over. But the engines on the Zeroes were supposed to warm up for 10 minutes. Apparently for best reliability? So they were idling and warming up. Again, "perfect is the enemy of very good." It was very lucky that we hit them right in that 10 minutes.

Thanks for writing.

rap

Good afternoon, RAP:

Your Yamamoto story was interesting, though the part on Lindbergh might be a bit short on detail accuracy. Lindbergh wasn't a captain. He was a civilian under contract with United Aircraft and later with Chance Vought. His charge was to improve range on the aircraft in the field for improvements on later versions of those planes, particularly the F4U. He held a reserve commission as a colonel earlier, but he resigned that in 1940.

Beast rgrds,
Ken Merrill

Hi Bob,
A couple of trivia associated with your column on Midway: Pearl Harbor wasn't intended to be a sneak attack, but the Embassy couldn't let low-level clerks see the highly classified message and had to translate and transcribe the message by hand. And our staff had most of the information in hand before the actual attack, but the military communications were down and they didn't put a high priority on the Western Union message (source: PBS *Codebreakers* show).

JL (Larry) McClellan

**Hi, Larry,
We also know that President Roosevelt suppressed many warnings that could have gone to warn our forces on Hawaii to watch out for trouble. Warnings were sent to every commander in the Pacific, but not to Admiral Husband Kimmel in Hawaii. Kimmel was made the scapegoat. He knew he'd been screwed.**

**Beast regrds,
rap**

Hi Bob,
I'm not sure how well we know that. Part of this is based on stories that are still labeled "Top Secret" even after 68 years. But the documentation is pretty firm. Roosevelt and his buddies really were in a conspiracy. There can be no doubt that it was the intent of the U.S. to push Japan into initiating the war, but as to foreknowledge of the actual 12/7 attack, the evidence really doesn't seem to be there.

(As I said, a lot of these secrets are still tied up, but I have no doubt they are real. The evidence is still blocked and hidden. The book about Kimmel is quite convincing. /rap)

I have read that all **(All except Pearl Harbor. /rap)** of our Pacific bases had been placed on high alert in November, but that no one had anticipated the kind and scale of attack that far east. The general expectation seems to have been that the attack would be aimed at the Philippines, where the U.S. forces were under orders to be ready to abandon the islands. The scale of the attack was such that very few of them had that option.

The alert status at Pearl was why the aircraft were parked cheek-by-jowl. The intent was to make them easier to guard against sabotage. **(That's still pretty stupid. This was long after 1939, and many people know that you space out the aircraft in revetments. /rap)**

The effect, of course, was to make them much more vulnerable to air attack, but virtually no one at that time believed that that scale of air attack could be mounted against Hawaii. **(I guess underestimating your enemy's capabilities can cause problems. /rap)** Yamamoto was simply a better tactician than anyone we had trying to outguess him. **(Yeah, up until Midway, i.e., seven months. /rap).**

The alert status was also the reason that the carriers were at sea, with them spending only minimum time in port, and then only one at a time. That seems to be the result of the planning and efforts of Halsey and Nimitz. **(And the battleships were chopped liver? /rap)**

There can be no doubt that Kimmell and Hart were scapegoated. The intention to throw them under the bus to get the public to buy into the war may well have been made in advance, but that seems to have been more after the fact than before it. The cost of Pearl Harbor was much higher than would have been considered acceptable. But then again the raid was much larger than virtually anyone in the West at the time believed could be mounted by a seaborne striking force. Perceptions changed over the next four years and most of the postwar analyses have been filtered through that hindsight. **(Fair enough. /rap)**

As to the internment camps (I forgot to mention it on the first note), *60 Minutes* (not the most reliable source, but entertaining) did a story some 20 years ago detailing how the roundup idea originated in the offices of the Presidio, supposedly at the behest of some large landowners in the Sacramento Delta area who coveted the extensive lands owned there by Japanese-Americans.

(No doubt. Along those lines, I was just reading yesterday that the Chinatowns and Chinese slums in every damn town up and down California and the rest of the West Coast just happened to burn down. Was that 1908? Such a coincidence... /rap)

Thanks for the reply. I know how big your fan club is and how much a timesink this kind of correspondence can be. Be well, and happy trekking.

Larry McClellan

**Hi Larry,
Yeah, but it's darned educational. Thanks for writing.
Beast regrds.
rap**

Hi Bob,

The Japanese lost the war before it started. The naval flight school accepted 120 cadets three times a year and failed out half of them. **(Did that not change after 1941? My God, that's stupid. (See below). We know that the Japanese (fortunately for us) did run out of good pilots pretty fast. Like, starting at Midway. Wow. That reminds me of the U.S. Senator who said "Aeroplanes? We've got one, haven't we?" But that was 1908. See below. /rap)** Read *Samurai*, the biography of Saburo Sato, Japan's leading ace.

The admiral who made the decisions at Midway was Admiral Genda, according to the biography *Yamamoto*. Admiral Genda had other black stars both before and after Midway. In 1937, war with America was discussed but put down by Yamamoto, et al, with the question, "How do you plan to conquer Washington, D.C.?" **(Even the Republicans are finding this a problem! /rap)**

The political scene changed and turkeys took over (same source). Japan lacked transport ships when the war started, a mistake they magnified by having transport ships give their estimated position in a broken code. (I don't remember the crypto book.) If Japan had taken Midway, the supply losses would have been devastating.

What mystifies me is why Japan didn't change sides in the fall of 1941. The Japanese fleet and the U.S. Pacific fleet would have ensured England, and free access to Vladivostok would have greatly aided the Russians when they were in doubt so they could have gotten one hell of a deal. **(Well, that is a good question. But supplying Stalingrad by way of Vladivostok would have been a beast! /rap)**

As a result of one of the NSC talks you gave, I invented a non-dissipating back-terminated line driver for both analog and digital application.

Ernie Richards

Hi Ernie,

There are many ways to back-terminate a line, though I'm not an expert.

About 1940, the Brits realized they had to greatly expand their navy and signed contracts for many destroyers and ships. Then they realized that each ship would need a navigator. At that time, a gentleman could enter a four-year school and emerge as a navigator—about the time the war was over. They decided to institute some good crash schools to educate navigators in six months, and when the ships started coming out, the navigators were ready.

Thanks for writing.

rap

Bob,

I don't remember seeing anything about the Japanese Internment of 1942 being due to decrypted messages, but it does sound plausible. **(I heard that just fairly recently. It is sorta believable. /rap)** The Brits let Coventry get bombed because they didn't want the Luftwaffe knowing that they had decrypted Luftwaffe communications. **(Exactly. /rap)**

As for the battle of Midway, the best book I've read is *Shattered Sword*, which goes into detail about the operations of the Imperial Japanese Navy. In particular there was an explanation for *why* the IJN planes were sitting on the deck when the SBDs attacked. It had to do with the Japanese engines needing 10 minutes warm-up time before takeoff. The authors also went into great detail about why the IJN carriers burned as much as they did when hit by the dive bombers.

(Because there were gasoline hoses and bombs all over the place! They were in the middle of refueling. They could neaten things up later, after the attack was launched. But did he comment on why there were no pickets? /rap)

On a more somber note, the book mentioned that several USN flyers were picked up by the IJN early in the course of the battle. They were tortured for information, and after the battle, their legs were tied to pails and they were tossed overboard. **(Yeah, I heard that. Did the Japanese military ever figure out that the torture and the mistreatment and execution of POWs was not a good idea? I guess not. /rap)**

One other surprising detail about the intelligence work prior to Midway was from Eddie Layton's book on his experiences as Nimitz's flag intelligence officer. He claimed that the ruse regarding the condenser on Midway was to convince Washington that Midway was "AF." The crew in Hawaii was already convinced.

Take care,
Erik Magnuson

Hi Erik,

It's important to get confirmation on things like that, when it is possible, without excessive risk.

I searched into several reasonably good and complete-looking stories about the Zero, and none of them mentioned this 10-minute delay. I guess the book you cited had done good research.

However, if the pickets had said "Dive bombers are here!" some of the Zeroes might have been able to take off and to hell with the 10-minute delay. The perfect is the enemy of the good.

Beast regrds.
rap

Hi Bob:

I enjoyed your article on Midway. Having flown out of there on patrol missions during the Cold War, I am familiar with the real estate.

G. David Germeyer

Hi G. David,

Wasn't it Midway where the pilots had to worry about the gooney birds on take-off? One B-24 was taking off, fully (over)loaded. It got a few yards off the runway, just barely above ground effect, and 200 yards ahead, the pilot was looking at a bird—and the bird was looking at him.

The pilot knew he had a problem, so he was hoping the bird would get smart and descend. Closer and closer. Finally, the pilot chickened out and descended a few yards. So did the bird! The bird had no better choice. The bird went through all the Plexiglass, and the bomber had to drop its bombs and fuel, but no GIs were killed.

Should the pilot have put in a 1/4-degree bank so the bird would hit the engine or wing? Not a big advantage! Anyway, don't assume the bird is smart enough to get out of the way. For sure, it's not smart enough to do anything else!

rap

Dear Bob,

Thanks for the interesting article on Midway. While the U.S. had broken the Japanese code, the code word for "Midway" was still unknown. So knowing that the Japanese were aware that the Navy had only two water purification plants on Midway, they started a series of messages in the clear indicating trouble with one of the plants. Soon, Japanese intelligence started discussing the implications of a water supply failure, conveniently using the code word for Midway. I no longer have a copy of Kahn's book, *The Codebreakers*, but I think that's where I came across this story.

Best regards,
Ralph Gaze

Hi, Ralph G.,

Yeah, I heard that story too. Good story! Needless to say, there were many games to be played, like this, with codes sorta broken.

Thanks.

rap

Bob,

Terrific story. I'm very interested to know if the Japanese did or did not explode a prototype nuclear bomb in Korea just before giving up. Those who dismiss this without a sober response to the alleged evidence do not convince me.

Michael Wright

Hi Mike,

I have never heard any claim about the Japanese doing significant nuclear research. If you've searched, and couldn't find anything, I doubt if I could find anything. I went over to Wikipedia at en.wikipedia.org/wiki/Japanese_nuclear_weapon_program, but the statements there indicate that hardly anybody believed anything about those claims. Have you read that? Have you asked Snopes.com?

I certainly believe the Japanese could have built a dirty bomb. However, considering how little the whole U.S. and Manhattan Project knew, almost nobody knew the long-term effects of low-level nuclear radiation. If the Japanese would have blown up a dirty bomb in front of a big U.S. invasion of Honshu, it wouldn't have slowed down the Marines one darn bit! And if they stormed ahead and got quickly through the nuclear crud, it probably wouldn't do them a lot of harm. Worry about dirty bombs is a modern concern. I bet the whole invasion force wouldn't even have one geiger counter!

I quit.

rap

What's All This DAC Stuff, Anyhow?

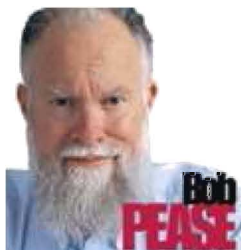

January 06, 2011 09:33 AM
Electronic Design
Bob Pease

Back 40 years ago, I decided I could design and produce a DAC—a digital-to-analog converter. But I was not going to fool around at 8 or 10 or 12 bits. I was going to design my first DAC at 16 bits (*see the figure*). At Philbrick we had a customer for a DAC at 13 bits plus sign, and I figured I could easily do that. So, I'd start at 16 and then back up.

The second bit was easy to design with a 10-k Ω high-stability (low-tempco) wire-wound resistor with a 20- Ω trim resistor in series, fed to the emitter of a PNP that fed the current to some more (well-matched, high-beta) PNPs, which were driven nicely by the sign bit. The second layer of transistors steered the current either to an inverting op amp (sigma') or to the main summing point (sigma) or to ground (OFF).

The reference bit was the same as the second bit and was servoed to a precision, very stable, 1.00-mA current-reference from a 6.200k wire-wound resistor from a stable 6.200-V reference from some 1N825s, etc. Details later.

The most significant bit (MSB) was the same as Bit 2, but with 5.00k and a 10- Ω trim, and it had two emitters in parallel. Bit 3 was the same but with 20k and 60- Ω trim and one emitter, etc. It's true that the VBE for Bit 3 was ~18 mV off from the earlier bits, but this causes barely 0.7 ppm/ $^{\circ}$ C of degradation.

These resistors' mismatches could have hurt the gain, but we specified that each set of them was wound with wire from the same spool. The feedback resistors (2.5k) were "Type HS" for fast settling.

We bought a lot of high-beta PNP transistors in those days, so we just graded them into 1/2-dB bins for beta and 1/2-mV for VBE match. We put nicely matched PNPs into blocks of eight wide and groups for high accuracy, all potted nicely into epoxy blocks to be within much less than 1/20 $^{\circ}$ C. It's true that we had to trim and pad a lot of the resistors to get everything matched well, but what kind of work would you do to make a product to earn \$800 in 1970 dollars?

Kicking The Tires

The customer plugged in our first demo and turned on the +5 V dc, the -15 V, and the +15 V, and he reached for the switch for the -60 V dc. But the DAC was already running nicely. It didn't need any -60 V. What the HEY? The customer was greatly impressed with our DAC's improved stability

and accuracy. It ran cool and efficiently.

We also included a de-glitcher (not shown) to disconnect the main amplifier while the bits were changing. After the bits had settled, the switch (~3N128) turned back on to let the output settle to the new level. This deglitcher ran at 4 MHz, and the customer loved it. This old machine is described on page 12 of the "New Lightning Empiricist" of 1971.

When I was leaving Philbrick in 1976, I found this first DAC, and it was still holding full 16-bit linearity. So I did know something about designing DACs. Good transistors are good transistors. Good resistors are good resistors. These days I'm using some nice slow 16-bit DACs, with a whole lot less effort. But I sure had a lot fun back in 1970.

Comments invited! Beast rgrds. czar44@me.com —or:
R.A. Pease, 682 Miramar Avenue
San Francisco, CA 94112-1232

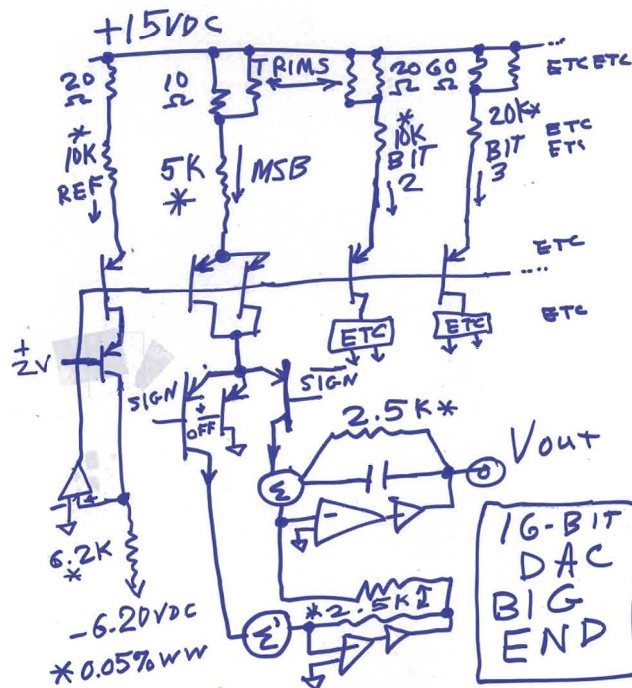

Readers Respond To Unintended Acceleration



January 10, 2011 10:51 AM
Electronic Design
Bob Pease

Greetings Bob;

I applaud your dispersal of this data (*see "What's All This Unintended Acceleration Stuff, Anyhow?"*) **(Thank you. I'm glad I did it. The recent disclosure of Toyota's payment of \$10 million to the family of four who died in a Lexus with a bad floor mat at 120 mph does remind us that this is a serious business. The driver was a policeman. Too bad he didn't know how to turn off the key. /rap)**

I learned this in my driving instruction from my father, many years back. **(Good man. /rap)** Back then, the older vehicles on the farm were prone to sticky throttles and such effects. The idea of rubbing a guardrail or other objects on the side of the road was more for downhill skidding on snow or ice but it holds true here. And turning off the key is, as stated, the last resort. **(Not at all. Driving into guardrails and rocks is the last resort! /rap)**

Care is required to not lock the steering, especially in a near-panic situation. **(If you reach for the key and turn it off right away, you can avoid the panic. /rap)** Your suggestion to practice this is very appropriate. **(Check. If you have a newer car, do you know what it feels like with the engine off? I'm sure you can guess. It's heavy! /rap)**

I am reminded to go over these practices with my wife and daughter, who are not good at driving in snowy weather. And no one knows when unintended acceleration will strike. **(If you don't practice it, that is when it will strike. If you do, it won't. /rap)**

As for the note on road hogs, Colorado also has a law. If a vehicle has five or more others behind it, it must pull over at the first available safe stopping point. And it is enforced. I have seen a ticket issued when the patrol car was the fifth car.

Russell Purkey

Hi Russell,

I am delighted! When that guy gets ticketed, somebody should make sure it hits the newspapers! There's a lot of two-lane roads in Colorado, and this can make them much safer. Thanks for writing!

Beast regards.

rap

Hi Bob,

I just read your column regarding unintended acceleration. Regarding the Audi UA events, I believe those were traced to EPROMs that were not programmed with enough charge on the floating gates for the logic states to be permanent. There used to be a "development" programming algorithm that would make it faster to erase the devices and make them last longer. The downside was that the programming wasn't "permanent" and bits could start to flip, and they apparently did. Another case of the digital world really being analog, as you have often pointed out over the years!

(One guy told me that the fuel-injected versions of the Audis that came to the States had a screw-up in the venting to the duct-work and manifolds, but the carburetted one that stayed in Germany had no such UA problem. /rap)

Regarding the UA in some of the hybrid Toyotas and similar cars, I never understood how people could be so confused and not do something obvious like turning off the ignition (without locking up the steering wheel) as you pointed out, until I drove a Prius hybrid as a rental car. The user interface is horrible with respect to the "key," which is really just an RFID fob, and the complicated sequence to power the car up and more importantly power it down.

I found the sequence totally counterintuitive given my 31 or so years of driving cars with conventional user interfaces. The required sequence doesn't match what most drivers today are used to with a mechanical key and a switch that controls the engine. After driving a car with such a miserable user interface, I can understand how people under stress, such as a UA event, could become flummoxed and make bad decisions that have tragic implications.

Best regards,
Gavin M. Monson

Hi Gavin,

Several people told me about this horrible interface. They asked me, "What am I supposed to do to defeat UA? If I need to turn off the engine, I have to push the power ON/OFF button for at least 3 seconds." I told them to beat on the Toyota dealer until they get a story they like.

Beast regards.

rap

Bob,

I just read your column about what to do if the engine won't slow down when you take your foot off the gas. I was surprised you didn't mention the easiest thing to do, which is to brake hard. The brakes on a car or light truck will safely dissipate energy at about 10 times the rate the engine will generate it.

(Yeah, but only for a short time, and only if they are in good shape. Using brakes may be jolly fine. But at the first hint that they aren't working, you have to turn off the key, or shift into neutral, real fast! Faded brakes are something I rarely bump into, but I know it's really serious. If you are going to just tromp on the brakes, don't screw around. Get the car to a stop very promptly. Putting on the brakes *real hard* at 0 mph wastes *zero* energy. At any other speed, most cars can't handle those kilowatts. /rap)

This is easy to prove by timing your 0-60 acceleration time **(Yes, I have a calendar. /rap)** and then your 60-0 deceleration time. In the 60-0 test, you're limited by tire friction, not by brake energy absorption. But in stopping a car with a runaway engine, tire friction doesn't enter into it and you can put even more energy into the brakes. Yes, if a timid driver rides the brakes with the engine racing, the brakes will overheat and fade. But if they brake hard, the brakes will slow the engine and kill it before the brakes overheat, even at full throttle. **(I think you are correct. But turning off the key can do even better. /rap)**

This is doubly important since turning off the ignition will not necessarily stop the engine **(That concept is unclear to me. /rap)** if it's running fast enough, **(Okay, what does that mean? I never heard of that. We are really talking about engines that keep running without the ignition on? I never run an engine that hot. /rap)** unless it's one of the newer ones with a fuel solenoid wired to the ignition switch. **(Which I do have on my Beetle. It's a newer, modern Beetle—1969. /rap)**

My father had this experience years ago after a pack rat built a nest on the exhaust manifold of a little-used car. At freeway speed the pack rat nest caught fire, heated the throttle cable, and melted the plastic lining in the end of it. After the fire went out, the cable was stuck in the wide-open position by the then-congealed plastic. As my father exited the freeway, he realized the throttle was stuck. He turned off the ignition, but it kept running either on compression or glowing carbon. **(Really! Then I guess he has to remember the next stage: shift into neutral, and let it blow! /rap)**

The brakes were sufficient, however, to slow the car to the point where the engine stopped. If he had panicked, he would have collided at 70 mph with a full four-way four-lane intersection full of stopped cars. I think it would be good to mention braking hard **(Not just "braking hard" but "braking seriously hard" to get the car stopped before the brakes die (fade). /rap)** because that's something even a panicky person is likely to be able to remember to do.

And by the way, I have no use for the drive-by-wire throttle controls. There are just too many things that can go wrong, and by the time you add all the safety interlocks needed to make it fail-safe, it would have been simpler and cheaper to run a mechanical linkage with a stout spring located right at the throttle plate, like all vehicles used to have.

David Sherman

Hi David,

Yeah, man, I'm with you. It seems that my advice has two prongs: one for stick-shift drivers, and a completely different one for slush-box drivers. The advice that is most natural for slush-box drivers (just shift into neutral!) is different from the advice for stick-shift drivers (turn off the key quick and it will slow down).

Yesterday, I was driving my wife's RAV4, and I turned off the key, and it just slowed down, and I still had power steering, and I still had power brakes, and I still had engine braking (which would be useful on a downhill). Slush-box drivers cannot imagine this!

Conversely, if I were on a flat road, as soon as the engine died, I'd shift into neutral and see how far it would roll (unless I was on a tough downgrade). Most slush-box drivers don't even think about engine braking, unless they had already downshifted into second or lo.

Beast regrds.

rap

Hi rap,

My first and only UA was in a beater 1980 VW diesel Rabbit with bad rings. I had used it only for city driving, 35 mph max, and except for a little smoke at that speed I considered the hundred bucks I had paid a bargain. That was until I drove on the interstate. At about 50 mph it took off and flatlined at about 85 without any accelerator pedal at all, no key either. **(I dunno, how do you convince a diesel to quit? /rap)**

This was accompanied by white smoke that was so thick it totally obscured the dozens of cars I had flown past during the run up. Foot brake, hand brake, shoulder, exit in that order, then park until the shaking stops. To parts store for rings, gasket set, etc. Nothing in the owner's manual or service manual. This was before the Internet and Google. My pulse rate jumped up just writing this. I haven't read anything about this anywhere since.

M. Keith

Hi M.,

Didn't the VW agency have any advice on how to shut off the engine? They Betta! Thanks for writing.

Beast regrds.

rap

Bob,

Like you, I prefer Volkswagens, although I happen to like their TDI diesels. I was at first astonished to see that they use a potentiometer as their throttle position sensor. **(I know a guy who put an AB type J on the control for the throttle on an F-86. These pots are very reliable. /rap)** Why would they use a wear-prone mechanical component like that, and not a sealed optical encoder of some sort? Then I got to thinking about the UA problem and how much easier it would be for the ECU to detect a faulty pot. A missing bit or two from the encoder could ruin your whole day. **(Uh, yeah.... /rap)**

Since VW/Audi was one of the first companies to get dinged for UA, this is not a surprising approach. The pots do wear out, though. One other UA mode peculiar to turbodiesels is turbo bearing failure. If engine oil starts spraying into the intake manifold, the engine will actually run on its own lubricant—for a short while, anyway. Turning the ignition off doesn't help. Best bet for those of us with stick shifts is to put the car in fifth gear and stall the engine with brakes before it self-destructs.

I don't know how you'd pull that off with an automatic. Pull over and stuff a rag into the air intake? **(Yeah, put a sock in it. /rap)** Yet another reason to buy a car with a manual trans.

Best,
Jon Wesenberg

**Hi Jon,
I sure agree.**

**Beast regrds.
rap**

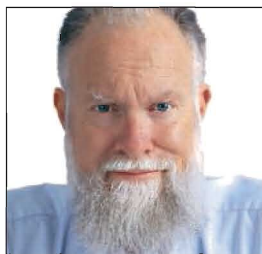

What's All This Unintended Acceleration Stuff, Anyhow?

I REMEMBER WHEN Audi cars were accused of unintended acceleration (U/A) several years ago. The experts forced Audi to lock out the shift lever if drivers didn't have their foot on the brakes. Drivers had to know where the brake pedal was before the car would let them shift into Drive. (Hey, I must say, that's not a bad idea.) Well, the cases of U/A decreased a lot. But I don't think they went to zero.

Now it's happening again. Some Toyotas are accused of U/A. Unlike older cars with mechanical linkages, most new cars have their throttle controlled by an electrical signal on a wire. If the (digital) computer decides to do something stupid, it may be hard to defeat it. But, sometimes, a black box can detect what went wrong. The jury is still out on that. The IEEE has been working on a new standard for black boxes for car systems. That's a good direction to work.

In my book* on pages 53-54, I explain quite clearly what to do in case of U/A. The first thing is to tap or jiggle the gas pedal, then hit the brakes hard, and if that's not working well, turn off the key! But don't turn it very far. Just far enough to turn off the ignition. And make sure you practice doing this, so you know what your car feels like when you turn off the key.

The steering may get heavy, and the brakes may not work so well until you tromp on them hard. But they will work, and you should make sure you know what will happen when you turn off the ignition. Practice in an empty parking lot.

My friend Les Sipkema said that these instructions should be in the owner's manual. I replied that nobody reads the driver's manual these days, except me and him and maybe eight other people in the U.S. So, I volunteered to write this to remind everybody that you have to know what to do in case of an engine that goes wild.

According to the book *Sudden Acceleration* by J. Cashelli, et al, it's not just old Audis or new Toyotas that go berserk. Many other cars do, or did: Fords and GMCs, and almost every other car. The car companies were pretty good at covering up such cases. They don't need a lot of publicity.

For many years, the car companies just blamed it on "driver error," as if the dumb driver hit the gas by mistake. And the National Highway Traffic Safety Administration let the car companies get away with it. But the actual rate for a surprised driver to hit the gas, in error, is down below 1%.

Finally, many car makers redesigned their cruise control modules and some of their engine controls, and the rate of U/A gradually decreased. After all, why in 1984 did Ford apply for U.S. Patent 4,472,777, a cruise control that was designed to avoid unwanted or unexpected vehicle acceleration?

Similarly, on pages 23-25 of my book, I provide comprehensive instructions for what to do in case your brakes fade or fail. These procedures are similar. You might downshift, or turn off the key, and use the handbrake. Scrub your fenders against a

guardrail—or even some rocks. It depends on if you are on a steep downhill or whatever.

Anyhow, a lot of you readers, as thoughtful engineers, already know how to do this. But does your spouse? Or your kid? They should know this.

TERRIBLE CASE HISTORY

There was a guy driving a Camry in Minneapolis. His engine surged in U/A, and he didn't know these procedures to slow down the car or scrub off the speed against a guardrail. The car shot up an exit ramp and whacked into the tail of a car there. Three people were killed.

Apparently his "defense attorney" was foolish and lazy and didn't defend him properly. The guy was sentenced to eight years on the basis of bad evidence and no defense. The defense tried to introduce evidence that the brake-light filaments had burned out, but this was considered inconclusive. One air bag had inflated, but the other didn't—again, inconclusive, but not presented to judge nor jury.

The insurance company said the crash damage was consistent with a speed "over 30 mph," but the defense attorney kept saying his client was doing 85 mph! Fortunately, my friend Les was able to get him some proper defense, and the district attorney let the guy out. Anyhow, if you're ever involved in a case of U/A, now you know what to do. Dive for the key! Don't just *hold on tight* and *hope* that the car slows down.

ROAD HOGS ON HILLS

Recently, we were reminded of hogs who go up a hill—or down a hill—on two-lane roads, very slowly and cautiously. They're often drivers of RVs. There's no safe way to pass them. And, these inconsiderate bastards fail to pull over and let people pass them, even if there is a wide place or turn-out for exactly that.

In California, we have had a law in effect for more than 40 years, Vehicle Code Para. 21656, "Turning out of slow-moving vehicles." If you have a tail of five or more cars behind you, you are required to pull over and let them pass, even if you are doing the speed limit! If you are so inconsiderate as to get ticketed for this, I will stand there and cheer on the cop! **ad**

**How To Drive Into ACCIDENTS—And How NOT To*, R. A. Pease, 1998; 488 pages; \$21.95; send check to Robert A. Pease, 682 Miramar Avenue, San Francisco, Calif. 94112

Comments invited! czar44@me.com —or:
R.A. Pease, 682 Miramar Avenue
San Francisco, CA 94112-1232

BOB PEASE obtained a BSEE from MIT in 1961 and was a Staff Scientist at National Semiconductor Corp., Santa Clara, Calif.

What's All This Small Hiker Stuff, Anyhow?



February 01, 2011 12:56 PM
Electronic Design
Bob Pease

Many readers ask me why I write so much about not-technical stuff. I reply that thinking about people and solving people problems can be quite challenging, and they may help us solve real technical problems—and then help us learn. Thus:

When our kids were 3 and 5, we decided to get them out for some serious hiking. We hiked them up Mt. Cardigan in New Hampshire, and they really seemed to enjoy it. We shortly promised them, “You keep hiking like that, and next April we’ll take you down to the Grand Canyon,” which is some of the best hiking in the U.S.

They kept hiking, and they were good sports. (Education comprises so many things you never can learn in schools.) We also had to be careful to not wear them out or get them too miserable.

We took them backpacking to the Grand Canyon, hiking down the South Kaibab Trail from the south rim. When we came to some big dropoffs, hundreds of feet below the trail, at first we held little Jonathan’s hand—because he was not even 4 years old!

Very shortly we decided that this little mule was an extremely surefooted hiker, and we bade him a “Hike along!” and for sure he was very careful. (We already knew that.) After a while we saw him, about 15 minutes ahead of us, 300 feet below us, waiting at the mouth of the tunnel to the bridge over the Colorado River. It was quite dark, as the tunnel had a bend, so he waited for us. We did eventually catch up with him.

(No, we never saw Jonathan trip or fall. And who did turn his ankle? Me. I absentmindedly bent the hell out of my ankle, turned it, while carrying a 70-lb pack full of equipment and water, but it did no harm. I had no trouble keeping going.)

[More Hikes With Kids](#)

When our granddaughter Amelia was about 4, we went on a hike along a nice woodsy stream in Mill Valley, Calif. It was a good trail, and she was obviously a good hiker. But when the trail ambled up to 10 and 15 feet vertical above the stream bed, I got a bit nervous.

Now, a really nervous Nellie could have screamed, “Be careful, Amelia!” But I realized that easily could have had the exactly wrong effect. So, I kept my mouth shut. I didn’t say boo. I wasn’t really nervous, but I was hiking behind her, and watching, and she continued to be a very competent, careful hiker. Even beside a little dropoff. No problems.

When Jonathan was about 12, we went for a walk on Candlestick Hill, which overlooks Candlestick Park in San Francisco. We circled around and followed a narrow trail, about 55 feet up. It circled along an old quarry, overlooking the ballpark. I’d never been there before. I was getting nervous.

Continue on next page

The trail got down to an inch or two wide, and I decided that, 55 feet above the ground, we would be better off to keep going than to try to turn around. I had confidence that he could follow me okay. And we made it. And it’s a good thing, because if I would have tried to hold his hand, and one of us would have fallen, we would both would have gotten wrecked. I don’t want to go back there, not even with a rope. Or two ropes.

A couple years ago, we took a four-hour day hike up above Reno. On the long, hot, slow hike back down, Amelia exclaimed, in a well-feigned sigh, “Oh, this so bad, I can’t walk any more... (sigh).” And then she ran down the trail a couple hundred yards. I like that kind of attitude!

[Memories Of Nepal](#)

Back in 1997, we were ascending above Sekethom toward Ghunsa in Eastern Nepal, to get to Pangpema, the 16,000-foot base camp for Kangchenjunga. The trail was high and steep, with big dropoffs.

We came up near the tiny village of Amjillasa. There was a gravel-slide slope with some parts of a trail across it. For 100 yards above us, gravel was trying to slide down, and for 60 yards below us, the gravel slid down to a dropoff we could not see, but it was many hundreds of feet above the Ghunsa Khola.

We had to hike along a narrow trail out to where the trail ended, take one long step, take another long step, and resume the trail. Ahem. I don't usually like that.

My wife took her two walking sticks, eased along nice and slow, and with the hand of one sherpa ahead, and one porter behind, she walked over just fine. I just hiked carefully, with my one walking stick, and got across just fine.

But one of the young (slight) women on this trek was pretty uncomfortable with this. (I don't blame her. I was, too.) So one of the tough strong porters threw her over his shoulder and carried her across! So there's another advantage of being young and not hefty. No, I did not get this on my camcorder. Sigh.

Hiking is good exercise for young people, but we have to be careful to not overdo it, nor wear them out excessively and discourage them. Just like other projects in life.

Comments invited! Beast rgrds. czar44@me.com —or:
R.A. Pease, 682 Miramar Avenue
San Francisco, CA 94112-1232



Figure 2: "That's a WTF" (Jonathan Pease, 1970)

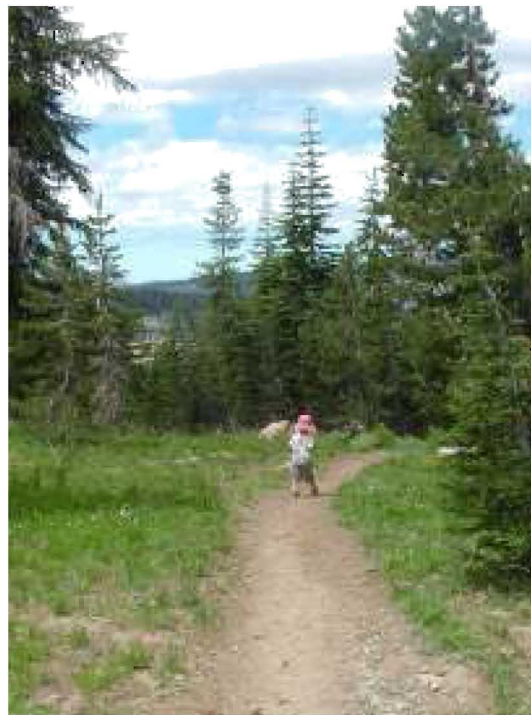
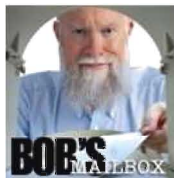

Figure 1: "I hope, hope, hope I don't lose the trail..." (Solomon Pease, 2008)
1. "I hope, hope, hope I don't lose the trail..." (Solomon Pease, 2008)

Bob's Mailbox: Audio Power Amps, DAC Stuff, Spice Suggestions, And Lunar Engineering



February 25, 2011 09:34 AM
Electronic Design
Bob Pease

Hello Mr. Pease:

Glad to see my EE hero is still around in semi-retirement. In fact you are so much appreciated by me, I posted your autographed pic on my Facebook business page. I wish you lived in Fresno and could have been my mentor. I would have preferred that over college. **(Next time you drive into San Francisco, we could get together for a bull session and beer. /rap)**

We have met and have spoken before, but not for several years. I kind of need some rudimentary advice for a problem that seems to be getting worse as professional power amplifier designs get more complex. Any advice you could provide would be very much appreciated.

Besides design, which I haven't done for several years now, my little company services pro-audio equipment, which is kind of lucrative and rivals profit margin against manufacturing. In my pro-audio service division, I service all sorts of professional audio equipment. You can see the details on my Facebook page if you are interested. Search "Dynastar Electronics" and then click "Like." **(I understand that the audio equipment may need some special repairs. /rap)**

I have a longwinded technical question that your *Troubleshooting* book doesn't really address, so perhaps you might have an article on the subject or can shed some light.

Commercial power amplifiers have become quite sophisticated: Class G, H, etc. They are not always worth servicing if it takes more than four hours to repair. I think other "repair shops" tend to just replace a channel PCB, stick a large bill to the customer, and be done with it. I think the truth is a lack of knowledge about repairing.

Since even AB-type amps nowadays can provide so much power (1 to 2.5 kW), they utilize a lot of paralleled power output transistors that become very difficult to find shorts on due to inherent low resistances in the circuit by design. I recently purchased a Tek DMM4050, so I do have the six digits I need to look for extra-low resistances, but PCB traces interfere with this technique of looking for shorts. **(At least five digits is a huge help. /rap)**

I often cannot use a variac effectively, or the ole light-bulb shunt on the ac line to bring up the voltage and dig around due to other complications, especially on more advanced amplifier classes. Often manufacturers are not much help, because they just replace PCBs and don't want to hassle with repairing them. They can afford to do that. **(I do understand that getting a number of "paralleled" transistors to test out can be grueling, but necessary... /rap)**

So here is what I end up doing to find shorted output transistors: I desolder B and E, then painstakingly go through each device with the diode test function and look for shorted devices while isolated. Occasionally, I must remove the devices to fully isolate it from PCB traces, then re-apply grease, mica washer, etc.

By not doing a repair in this tedious manner, I take a risk of re-assembling the amp with a shorted device remaining, risking re-damage, or having to dismantle the unit again for re-diagnosis. I don't always have access to lifting emitter resistors and associated support parts with dense integration these days. It takes a long time to this, and there is a point where I have to start eating my time, otherwise the end customer could just purchase a new power amplifier. Some of the brands I work with are Peavey, QSC, Crown, Carver, and others.

Continue on next page

(Maybe you should warn all these makers that they are risking a lot of customer dissatisfaction if they don't make better layouts that can be tested and troubleshot. It's a bit late, but start straightening them out. /rap)

Given the dozens of paralleled output transistors on a typical unit, what is the best and/or most efficient way to find a shorted device(s) amongst the group? **(Wow, I think you are doing about the best you can. /rap)** What am I missing here? Many times I have had to let the repair go, because I passed the estimate, so I took a loss. **(Sometimes you have to keep on investing a little more time to find out what is really wrong. Maybe that can help teach you what to do next time. /rap)** I'd like to change my ways, mentality, or whatever it takes. I have been doing this method for years. Any help you can advise me with would be very much appreciated.

Aram Tokatian
Dynastar Electronics

Hi Aram,

I'm afraid you are using some of the best T/S approaches you can. These equipment makers are not helping you. They really are paralleling the devices? Bastards! I'm putting five PNPs (TIP-42s) in ~ parallel, but they each have a base and an emitter resistor. I used to work on 12-packs of 2N4860 FETs that were paralleled, but it was easy to swap them out as a 1- by 0.8-in. submodule. No bolts needed.

Beast wishes.

/rap

Hi Bob,

Your digital-to-analog converter (DAC) article really started me browsing and travelling down memory lane (see "What's All This DAC Stuff, Anyhow?"). At one time I had acquired a Philbrick applications manual. **(Yeah, the big 1966 one. If you go to the Analog Devices Web site, you can find the whole book, 140+ pages. Of course, it will take you some time and paper to print it out. But ADI did a nice service. If you can't find it, philbrickarchive.org should help. If not, holler to me. /rap)**

At one point I used information from it to build a linearizing network for a voltage-controlled crystal oscillator (VCXO) I needed for a test. Shortly after that I loaned it to someone and never got it back. It was a great manual and I have missed it ever since. **(Now you're in luck! Now, everybody has a printing press! /rap)**

I also clicked on one of the links in your article, which took me to the Philbrick archive site. That prompted me to go to the garage and check my junk box. I found six PP55 modules. I don't remember where or how I got them. They look like pulls. I probably should power one up and see if it still works. **(The PP55s are 99.9% likely to be good. Good old machines. Comparable to a '741. /rap)**

Ditto for the CK722 that is in the same box. My dad got me some for Christmas when they first came out. I think he paid \$9 bucks a pop for them! **(I don't know that much about the CK722, but it's a good historical artifact, even if it just barely wiggles. Those old pieces of germanium were not hermetically sealed, nor planar passivated. If you wanted to use it to build a one-device radio, your chances are about 50%? /rap)**

Continue on next page

Just for laughs, you can see my first computer at www.retrotechnology.com/aux/swtp6800.html. I also have www.bmblack.org (mostly personal) and www.bmblack.com (consulting business). I was laid off 4/15/2010, so I am trying to get the consulting moving again.

B.J. Black

Hi Bruce,

Will view later. Thanks for writing. Lunch time. Beast regrds.

/rap

Hi Bob,

Okay, Bob, kiddie Spice is for the rest of us. But surely the smart analog designers now have special CAD that models all the thermal coupling on the die. **(Largely not. Relying on symmetry and 'centroid usually works much better. /rap)** Or is all that symmetrical/diamond layout stuff still just guesswork ?

(A mix-master that can run Spice and do thermal analysis at hundreds of thousands of points, on and in one die, is a slow machine—and I have seen machines these days make the most horrible errors. Have you ever run OP-07s? Sometimes I do, and sometimes I don't. Most of the guys who can run a computer that big, complex, and powerful have no idea what the results mean, especially if the output involves a stupid error. A little thermal analysis may be done well. But why bother to use a digital computer to show you how to find an orgasm, when you still have to know how to urinate? Do you need a computer to teach you that? /rap)

I am sending you a nice, simple low-dropout regulator (LDO) cct with a -90-dB V power-supply rejection ratio (PSRR). **(I'll look for it. But be careful of its weaknesses. I'll assume you'll tell me what you think it's good for. Then I'll have to tell you what it's bad for, if anything. /rap)** Since you know the most about the LM317, would you please point me to the best Spice model you know of?

JCP

Hi Julian,

I still use Pease-Spice, which is, "Back-Of-Envelope Spice." I don't know anybody who has a good model for the LM317. Many of its errors and imperfections are thermal and not easy to model.

Beast wishes.

/rap

Dear Bob,

I just read an article claiming that “signals from seismic sensors left on the lunar surface by Apollo astronauts in 1971 have revealed that the Moon has a liquid core similar to Earth’s.... The Apollo Passive Seismic Experiment consisted of four seismometers deployed between 1969 and 1972, which recorded continuous lunar seismic activity until late 1977.”

When I read this, I recalled your article on “What’s All This 2401BG Stuff, Anyhow?” and I’ve got to believe this is all part of your handiwork. You can read the very interesting article on the data collected from the seismic sensors.

Kind Regards,

Arlie Stonestreet II

Hello, Arlie,

Yeah, I heard that yesterday on NPR. Thanks for hollering. I’ll check it out.

When we originally acquired those data, we found some interesting info. But now we have much better computing capability, so we are starting to find out new nuances about the internal structure of the moon. Solid core, liquid core, too?

Yes, I’m sure all those data came from 2401BGs.

Thanks for writing.

/rap

Bob's Mailbox: Advice To A Young Engineer, Julie Resistors, Key-Less Acceleration, And Hiking with Kids



March 07, 2011 10:24 AM
Electronic Design
Bob Pease

Dear Bob,

I am Ronald. I am from India. I came to know about you while I was searching on Google for the history of op amps. I have read all your articles that are available at the following link: <http://www.national.com/rap/Story/Index/0,1563,0,00.html>. **(Most of these are good ideas to study for analog applications. /rap)** I have a bachelor's degree in electronics and communication, and I am presently working at Mindtree Ltd. as a software application engineer. **(Software applications are probably not very much at all like analog design. But since I've never written any software, I'm no expert. /rap)**

I am looking for a job at National Semiconductor (NSC) as a digital/analog design engineer in the United States. **(First of all, NSC is not doing much hiring. Lots of companies are not doing much hiring. You've probably noticed that. So have I. /rap)** I have gone through the National Semiconductor job search site. All the positions there ask for experience.

(All design engineer jobs at any company demand experience—preferably lots of experience. This is not new. So, what kind of experience do you have designing or building anything? Have you built little applications circuits that work? That is where you have to get your feet wet. After you have built something, you have to make it work. Have you built lots of small circuits and systems, some analog, some digital-and-analog, some digital? /rap)

I don't have experience in digital/analog design at a commercial setting, though I have an educational degree in it. I only have software experience. **(If you have only software experience, you are very far from doing analog or digital circuit design. /rap)**

Is there any way I can get a job as a digital/analog design engineer at NSC without any experience? **(Absolutely not. /rap)**

In the article "What's All This Mentoring Stuff, Anyhow?" you talked about mentoring (*see <http://electronicdesign.com/article/articles/what-s-all-this-mentoring-stuff-anyhow-6148.aspx>*). I am a quick learner and with proper guidance and mentoring I will be up to date with all the required skills to design innovative products and bring value to NSC.

Thanks and Regards,

Ronald

Hi Ronald,

If you don't have six to eight semesters of studying analog systems and circuits, you are nowhere near having "all the required skills." If you build lots of little circuits and start to design your own circuits and systems for at least five years, you may be getting close. Do you know how to design using voltage regulators and op amps? These are very important.

After you have done the six to eight semesters, or equivalent, and have built lots of circuits that work, you would be close to having enough experience to apply for a job as a linear applications engineer in discrete circuits (not for an IC company). That's what I did about 50 years ago.

After five years of such work, you may show your ability to design detailed circuits using ICs, transistors, resistors, and capacitors. That may take another five years. I did that from 1960 to 1966. I helped many engineers to solve their problems. I used transistors and linear ICs to make little modules with precise characteristics.

You also have to know a lot about measuring analog signals, ac and dc. You should study a lot about audio amplifiers, audio circuits, DVMS, and oscilloscopes. When you know every part inside of a scope or DVM and why it was put there, you'll be in good shape. (I put in five more years doing that.)

Five more years of serious design work will get you to where you could apply for a job as an applications engineer at an IC company. That's about what I did.

Five more years as an apps engineer, and then you can start designing (and revising and studying) existing ICs. Maybe by then you can start learning the techniques of designing ICs enough to be helpful as an assistant.

If anybody says he knows any shortcuts, he's probably full of crap. If anybody says he knows of a school that can teach you how to do it with less time and higher confidence, he is very likely full of crap. Oh, yeah, if you want to be a good circuits engineer, you have to learn as much as possible about how to analyze circuits without using Spice. But nobody learns that these days. Nobody teaches that.

I apologize for being slow to reply, but I answer easier questions quickly, and the harder ones take more time. Got the picture?

If you are reasonably good at software, then a comparable course of study may be a little easier for you. But what tasks have you gotten done with software? What systems have you designed with software? Did they work well?

My advice on software is substantially worthless, as I've never written any. So my path to be a software engineer would be almost as slow as your path to be an analog design engineer.

If you want to be an analog engineer, you must also have the right kind of aptitudes. If you don't have them, you'd be wasting your time and spinning your wheels. Obviously, I have no idea where your aptitudes lie. Let me find some ideas on this soon.

I apologize for being so brutally honest, but anything less than reality would be doing you a disservice. You should go in the direction your experience and your aptitudes are taking you. See "What's All This Aptitude Stuff, Anyhow?" at <http://electronicdesign.com/article/articles/what-s-all-this-aptitude-stuff-anyhow-6109.aspx>.

Best wishes.

/rap

Bob,

I enjoyed your story about the digital-to-analog converter (DAC) at Philbrick Researches in the 1960s and your mention of the high-stability wire-wound resistors (see "What's All This DAC Stuff, Anyhow?" at <http://electronicdesign.com/article/analog-and-mixed-signal/What-s-All-This-DAC-Stuff-Anyhow-.aspx>.) I was wondering if the manufacturer was Julie Research. **(We used Julie resistors to make 1 Ω , 10, 100, and 1k, about as big as a baby's fist, for various precision projects. But in the DAC, Julie Research Laboratories (JRL) was not competitive. What we bought was 1/4 by 1/2 in. long. /rap)**

Around 1964 or 1965 I worked for Julie Research, which made hand-wound-wire resistors made out of Evenohm **(That is Evanohm, I believe. /rap)** from Wilber Driver wire, potted in black epoxy cement, in their building on W 62 St. in Manhattan. **(I've been there. /rap)** Loebe (Loebe Julie of Julie Research Labs) mentioned he had worked at Philbrick before founding JRL. **(I am indeed told he worked with George Philbrick, but I never knew what their business arrangements were. I'm sure I was 2 or 12 years old at that time. /rap)**

If you are interested, I could recount my first real engineering job as a 19-year-old undergraduate at CCNY's engineering school. **(I'd be delighted to hear your story. My March 30 column will be about George. /rap)**

Regards,

Al Schwartz

Hello Al,

I do not have custody of one of those DACs, but I recall plainly the wire-wound resistors from RCL. RCL knew how to wind sets of resistors from one spool and how to wind them for Type HS. Not all the R makers did. Did you ever see Loebe winding up resistors for type HS?

Thanks for writing. Beast regrds.

/rap

Hi Bob,

I read your article "What's All This Unintended Acceleration Stuff..." (see <http://electronicdesign.com/article/analog-and-mixed-signal/What-s-All-This-Unintended-Acceleration-Stuff-Anyhow-.aspx>). You missed a very important point: Today's cars don't have an ignition key; they have "key-less" systems instead. **(Cars have keys. Crap computers have "paddles" and push-buttons and "Mother may I?" power systems. I'm not buying any of them. I hope you aren't, either. Fornicate "today's cars." I know how to rip out the batteries from my computers. I don't need permission to do that. /rap)**

You have a "pad" that you put in a square hole in the dashboard, or in some cases, a pad you only need to have close to the car (remote sensing). **(Fornicate that! Can I shut it off or can't I? If I can't, I won't drive it. I won't buy it. /rap)** The pad gets locked in and then you push a start/stop button. This button is deactivated when you drive (I guess so you don't accidentally stop the engine while driving).

(Toyota and Lexus say you don't have to "stop the engine when you drive," even if the gas pedal is stuck with the throttle open, or even if that causes me to go 125 mph... No. My wife has a good old Toyota, and it has a key. She knows how to turn it on and how to turn it off. I do, too. I know how to find them in the dark. /rap)

You take the pad out by pushing on it, but this is also deactivated while the engine is on. The only way to stop the engine while you are driving is to push and hold the start/stop button for more than two seconds (in most cars, but it is not stated anywhere in the car manual, at least I have not found it in my BMW manual).

(You have my permission to beat up the Bimmer guys and put the fear of God into them. Demand a good (emergency) solution!! Even they have to learn to take the customers seriously. Tell them you already have a \$50 million lawsuit, with

all of the names of their employees, typed out and ready to file if you don't like their answers. /rap)

Sorry that the 911 dispatcher didn't know that when four people were killed in the famous Toyota crash in California. **(I'm very sad that the agency gave them a loaner car with no warning and with an oversized floor mat. But there are a lot more than four people who died. /rap)**

I would like if you could write about this soon in your column, as I don't know how many people know about this. **(I've covered this. See my follow-up to the column in "Bob's Mailbox: Readers Respond To Unintended Acceleration" at <http://electronicdesign.com/article/analog-and-mixed-signal/Readers-Respond-To-Unintended-Acceleration.aspx>. /rap)**

Regards,

Hans Hammarquist

PS: The verdict is out and they found nothing wrong with the Toyota software controlling the throttle. How surprising! Did anyone with software experience really think they could find this "bug?" If you could find a bug in that short amount of time, Microsoft would not have to update its software every Tuesday.

(Maybe Toyota has better software than Microsoft. I tend to believe that. My documentation of criticizing and despising Microsoft has been posted (see http://electronicdesign.com/article/embedded/what_s_all_this_microsoft_stuff_anyhow.aspx). I had a lot of trouble when I got this MacBook, but it's running pretty well these days, after months of struggling (see http://electronicdesign.com/article/pease-porridge/what_s_all_this_mac_complaint_stuff_anyhow_.aspx). /rap)

I still believe there is a bug that caused this accident and many (but not all) of the other accidents.

Hans

Dear Hans,

It used to be 1% of unintended acceleration that was caused by tangle-foot drivers. But most cars got better, so now it may be 90%. Several readers told me that in case of unintended acceleration, they thought shifting into neutral was better than turning off the key. Unfortunately, most cars with the engine screaming and the throttle stuck wide open can lose their power brakes, due to low manifold pressure, so turning off the key is usually still safer.

Beast regrds.

/rap)

Bob,
I always feel nervous with my kids and grandkids on steep trails (See <http://electronicdesign.com/article/analog-and-mixed-signal/What-s-All-This-Small-Hiker-Stuff-Anyhow-.aspx>). A long time ago, a member of our church gave a talk about going to Niagara Falls with his grandson, who ran ahead of him. When he got to the end of the trail, a cliff over the falls, there was a big crowd gathered. His grandson had gone over the edge of the cliff, but had not fallen in the falls so he was able to be rescued. Ever since I heard that story 30+ years ago (and I am not sure now who told it!), I get nervous with children around cliffs!

Good article!

M.

Hi M.,

Kids who have shown good judgment are likely to continue to do so. Kids who don't know how to stop when they come to a fence need to be restrained somehow. Maybe a leash? I used a harness and leash on my kids when they were small. My parents used a harness and leash on me when I was small. Sometimes it's the right thing to do to keep them from leaping out into dangerous places, like highways, where they are not good at understanding the danger.

/rap

What's All This George A. Philbrick Stuff, Anyway?



March 21, 2011 12:00 AM
Electronic Design
Bob Pease

When I joined George A. Philbrick Researches in 1961, I did some technical writing for the R-300 power-supply family. Then I worked on some analog computer components and advanced vacuum-tube amplifiers like the SK2-V.

Just as I was finishing off those projects, George Philbrick (founder and head of the company) grabbed me to work on some advanced technical stuff. I was designated as VP for Development, and I was cooking up lots of projects—and reporting directly to George. Silicon transistors were coming along, and I sure did start learning a lot.

About this time, Tim Noble and Al Pearlman left Philbrick, so I worked on some hot amplifier projects. For example, see “Design of a Modern High-Performance Operational Amplifier” at www.philbrickarchive.org/1966-07_v14_n01&2_the_lightning_empiricist_01.htm (the P85A, p. 6) and “New Products” at www.philbrickarchive.org/1965-07_n01&2_the_lightning_empiricist.htm (the P25A, p. 2).

I had a lot of fun, and wild challenges, for many years. George was not a simple person. He was often quite a visionary. But I got along with him well, and we had a weekly one-hour meeting on interesting learnings from the projects I was working on—and odd ideas.

The Saw-Mill

One day, about 1963, George told me about a sawmill he had invented several years previously—maybe 10 or 20. Unlike most sawmills, which run at a constant nominal speed but slow down a bit when you feed them a lot of logs and work, his sawmill would run at a barely fast idle. And when you fed it boards or logs or work, it would speed up to its best cutting speed.

I had studied analog computers enough to know that, despite the problems of closing a loop around a lag, this loop was feasible. Specifically, if you put a little more flywheel on the saw blade, you could compensate for this lag, using a suitable differentiator (or lead) inserted in the control loop. This loading would be perfectly distinguishable from a similar amount of friction, and a loop could (in concept) do this just fine. Over the next four or five years, George mentioned this to me a couple more times. I agreed it would work well.

In 2010, I started wondering what the other expert engineers at Philbrick remembered about it. I called up Dan Sheingold (apps manager) and Peter Hansen (manager of analog computation). What did they recall about George’s sawmill? To my great surprise, neither of them had any memory of GAP talking about it.

Why did George challenge only me, and not the others? Well, I was the youngest kid engineer in the company. Maybe he was just testing me. But I didn’t get mad or confused. I knew he could make that sawmill, and I knew I could do it, too, using George’s standard analog computing techniques.

But did GAP ever publish this concept? Did he ever demonstrate it? Or did he just talk about it to impress people? That is hard to say. None of us could figure that out. Maybe George just simulated this loop and proved its feasibility. Maybe.

But I did realize that in the 1940s, the cost of energy (steam or gasoline) was pretty small, hardly worth saving a few seconds of the cost of energy between a fast idle versus a slow idle. I had done a lot of helping my father saw up old logs and branches. He never let me do any sawing, but I really did know a lot about sawing stuff. So George didn’t fool me at all.

I also knew that a fast blade can blast through some small or medium-sized sticks, very quickly, and if you had to wait for the slow idle to come up to fast, just to cut a few small limbs, productivity would be hurt.

5-MHz Power?

Also at those weekly one-hour meetings, George told me how he wanted to improve the world by getting away from 60-Hz power and its heavy, bulky power transformers. He had done a lot of work with 5-MHz sines and square waves, so he was reasonably knowledgeable. Thus when he proposed that we all ought to do away with 60-Hz power transformers, I was impressed. He listed the advantages: it would be cheap, using small, cheap transformers; power filtering would be easy, etc.

I immediately began to suspect that he was playing devil's advocate. But I was not quite quick enough or strong enough to rebut him. I tried to figure out how he wanted me to reply. In retrospect, it's pretty certain that he wanted me to rebut this proposal.

First, the noise sprayed into the air would be excessive, and the local noise would be horrendous. Further, the power losses (by radiation or conduction) for 10 W, for a few meters of route, would be horrible—not to mention a mile. The whole scheme would clutter up the whole electromagnetic spectrum in the neighborhood just something awful.

Again, George proposed this scheme to me three or four times, and I never balked or protested. Maybe I was reticent to criticize an old senior engineer who happened to be my boss. But I do think George was just testing me. Did George fool me? Probably.

I'd love to tell you about George's P7, but that will have to wait for another day.



What's All This Hydraulic Ram Stuff, Anyway?



March 23, 2011 08:40 AM
Electronic Design
Bob Pease

When I was a kid, I was impressed with a lot of things you could buy from the Sears & Roebuck catalog. One was a “Hydraulic Ram.” If you had a small stream on your land, you could buy a hydraulic ram to take in a lot of low-pressure water and pump a little of the water to a higher level, such as up to your house.

It wasn't very efficient. It was LITERALLY clunky. The water would flow past a small chamber, building up inertia and momentum. Then a clack-valve would close, converting the momentum to pressure. The pressure would cause a small amount of water to squirt up with enough pressure to get the water up to where you needed it.

The oscillator was obviously “self-starting.” This is one of the first places where we could be exposed to a “switch-mode converter.” It worked that way back in 1940, and surely for 60 or 80 years before that. It was not a “switching regulator,” as no regulation was involved. But it was a kind of magic! Enough to get a nascent engineer thinking. Isn't it funny that a current flowing in your stream has the same name as the current in a wire or inductor? With various analogous properties.

Around The House

Back in 1957, I was shovelling a little snow, about 3 inches of wet snow from a sidewalk. I would scoop up a medium shovel-full and throw it over a small hedge. But if I did not quite get the snow above the hedge, some of the snow would hit the edge of the hedge and push it over a couple inches.

As most of the snow fell away, the hedge would spring back and throw a small amount of snow back onto the clean sidewalk. Maybe just a tablespoon or two, but enough to notice! I had to go back and clean up these dribs and drabs of snow. I remember this clearly.

Recently, my wife began complaining that I was leaving our range-top kind of messy. How so? When I make coffee, I get the coffee cup half full of coffee and then pour in about an eighth of a cup of cream (half-and-half) from a pint carton.

When the cream hits the coffee, it disturbs the surface of the coffee, which then throws one little drop of cream up and out and over the edge of the cup and onto the stovetop. This is a lift of a full 1.5 inches. It's another example of a switcher—very informal, but not made by human hands. I've even watched as a small stream of milk caused a drop of the milk to leap 3 inches above a half-full cup of tea, over the edge of the cup, and onto the stovetop.

Does water make a splash like the cream does? Milk? Heavy cream? I haven't run any tests yet, but yeah, the cream does tend to splash up more than water does.

My father had a 1941 Ford sedan, and it had a radio. I did not know it, but the “whine” we heard from the radio was a vibrator making a switching converter, taking in a lot of power at 6 V and putting out a few milliamps at 90 V to run the plates of the radio tubes. At that time, I was not repairing or taking apart car radios, but I bet some of you guys were. Comments?

More Fluid Dynamics

The ability to store energy in a slow flow of water can lead to a crude pump that can raise water above “ground level.” The hydraulic engineers back in the 1870s were pretty ingenious!

The money from gold mining made a lot of experiments and engineering possible. The ability to store energy in an inductor, and suddenly “break” or “switch” that path, led to the whole switching regulator industry we see today. Step-up and step-down.

What does this mean to those of us who do not use “switchers”? The other day, I had to pour some water into my car battery. Watching closely, I saw that as the water blooped into the battery, a tiny drop of liquid came out.

I didn't have any pH strips, but I bet it was pretty strong acid, not just water. To avoid holes in my shirt, I'd better stay away from these little drops! Comments?

Dirty Dealing? By my Rich and Wise Uncle Sam?

Recently I got a refund check on my state taxes. When my wife asked, “Do we have to pay taxes on this income?” I replied, “Oh, yes...”

Then I realized that when I earned the money, I had to pay federal and state income taxes on it, and the state taxes may not be exempt

from federal tax. So I have to pay tax on the taxes. Then, because my income was so hard to estimate, I overpaid my state taxes—and I have to pay more tax on the tax on the tax.

Tax experts tell you that if you overpay your taxes, it's no big deal. You just have to wait until you get your refund. But nobody (except rap) is telling you that you may also have to pay taxes on top of the taxes. And even on top of the refund.

So it is worth some effort to pay up near your tax due and not overpay it, because your refund may get screwed. The last time I looked, the IRS tax rate was up near 43%, and at that rate, double taxation is painful!

So, do as I say, not as I did.

Bob's Mailbox: PLL Circuits, Hiking Experiences, And More Reader Reactions



April 04, 2011 10:52 AM
Electronic Design
Bob Pease

Hello Bob,

It has been quite a long time since we communicated. I was reminded of this as I was cleaning out old e-mails. Mostly it has been my fault, as I have been quite intensely busy searching for a job and attempting to get my dad's house ready to sell. He passed away last April 15, at 90 years old and still living by himself, and mostly taking care of himself. But now it is some big task to get the house into a condition in which some younger person would want to buy it. After all, I don't think that there are many really old people looking to purchase a larger house.

Aside from that, I have been sort of interested in the new LF band frequency that may be given to radio amateurs. It is in the 162-kHz range, I think, although there may also be an allotment in the 462-kHz area. My thinking has run toward direct conversion, image-cancelling receivers using the "Tayloe" circuit, which seems to be the CMOS equivalent of the diode-ring mixer, but using an analog switch IC and running into both inputs of an op amp.

These frequencies should be much less dependent on circuit layout than the VHF circuits, and possibly less demanding on IC high frequency performance as well. I don't know if you have investigated the Tayloe detector, but there has been a fair amount of stuff about it written. **(Of which I have seen or read nothing. Where'd you get the idea I know anything about radio? I'm dumber than three boards. /rap)**

The nice part is that getting the required 90° phase shift is quite simple using cheap digital logic, at these lower frequencies. Relative to that, I wonder if you have done much experimenting or developing with phase-locked-loop (PLL) circuits. A PLL system is mostly analog. Even the digital part is really analog, after all.

William Ketel

Hello Bill Ketel,

Yeah, old people and old big houses do cause interesting problems.

I was on the distribution list for a PLL study group 28 years ago. One day, a guy asked me if I could help him a little on a low frequency PLL. I said, "I can take a look at it.

What's your frequency?" He said, "20 MHz." I stopped and thought. I told him, "Where

I come from, a low-frequency PLL is 20 Hz. No kidding."

See at AN-210, which I wrote 32 years ago (www.national.com/an/AN/AN-210.pdf). Yes, I did once make a good PLL at 200 MHz, but that was a stretch for me! I was using a couple 1N914s for varactors!

Best regards.

/rap

Bob,

I, for one, enjoy reading about your exploits—everything from Philbrick to Nepal. Please keep up the flow of information from one who is a wise soul to us many neophytes (and some say Neanderthals). **(I do plan to keep writing. /rap)**

Reading in the latest *Electronic Design* about hiking with the wee ones made me reflect back on an incident my wife and I had while on a short day hike in Australia back in 2003 (see "[What's All This Small Hiker Stuff, Anyhow?](http://electronicdesign.com/article/analog-and-mixed-signal/What-s-All-This-Small-Hiker-Stuff-Anyhow-.aspx)" <http://electronicdesign.com/article/analog-and-mixed-signal/What-s-All-This-Small-Hiker-Stuff-Anyhow-.aspx>). It was early March and we were in the New South Wales village of Tenterfield, which is a fantastic town with a marvelous

past. Bald Rock National Park is located a few kilometers outside of town. Bald Rock is the largest piece of granite in the Southern Hemisphere and we were assured by many that it was a very easy hike to the top.

Indeed it was, after parking our hire car (as “they” call rentals) we began the very pleasant 2.5-km hike to the summit. Most of the journey was through savannahs and mossy forest. The path was well worn and well marked. (Oh, and something you should know—I left my handheld Garmin in the car, and this was the days before smart phones. I had a Motorola Flip with me.)

As we began the ascent to the summit, which was not all that difficult, the trail markings became fewer and fewer. **(Oh, that’s a caution! /rap)**

I guess the park service reasoned that up is up, so why bother marking which way is up?! We did notice that at places we were to turn, someone had placed small drops of white paint, usually three at a time to show the way. **(How charming! /rap)** In a short while, there we were enjoying the summit and the commanding view of the valleys below. There was a survey marker as well as a guest book to sign. We were about the eighth party to visit that day.

As quickly as you can say “down under,” the weather turned from slightly cloudy to insanely intense thunder and rain. It wasn’t a matter of “Oh, a storm’s coming,” it was “Oh my God! Let’s get out of here!” (We had no rain gear). **(Nobody has any lightning-proofing! Nobody volunteered to act as a lightning rod for the group? /rap)**

Hurriedly we dropped down from the summit only to realize that everywhere we looked, it looked the same: a sloping granite block leading to the forest. The white paint drops weren’t visible anymore as the glare from the sky coupled with the rain made them have little to no contrast. **(Check. So you should complain to the rangers! Even now! Insist that they add small, tasteful but noticeable arrows... /rap)**

We dropped from one ledge to another, only to make it into a forest patch ending in a 40-foot drop. A retreat led us to an escarpment and a very precarious situation. **(Uh, yeah. And there were no landmarks or markers of any sort to guide you to the trail. Trouble! /rap)** We looked left, right, and even to the other end of the rock and could not find the path back to the trailhead.

I was just about to dial “000” on the cell, which is Australia’s equivalent of 911—the signal reception was phenomenal—when we heard someone yell up “Hello!” It was a party of Americans much better equipped than we, as they had rain garments and warm clothing. They were on the way up when the rain hit and decided to hunker down. As the rain let up (it lasted for, say, 10 minutes) they resumed their hike. We were still in a panic to get out of there because we were soaking wet and very cold. **(Exposure to cold rain can be very serious. You recognized that. /rap)**

We explained what happened to us and asked if they knew the way back. They pointed out the trail to us: “Look towards the right of those two trees down there,” and sure enough, it was a short sprint back to the car. **(Yeah, but it was still not obvious! /rap)** Yes, we were ill-equipped but this was a short hike in a public park on a marked trail. **(No, on an almost marked trail. Man, what a difference. /rap)** The weather was sunny when we started. **(I don’t know the weather “down south.” But I know there are a lot of places where the weather can change fast. I guess that’s a good reminder to always bring a parka or poncho. /rap)**

What would you have done to ensure that you never got in this mess?

I’m kicking myself to this day for not bringing my GPS to mark the trail, but would it have been all that helpful? **(Oh, yes, a GPS might have been useful, but you’d have to remember to mark a few waypoints on the way up. /rap)**

Karl Strauss

Valencia California

Dear Karl,

A lobster goes out for a walk on a fine day. He finds an appealing entrance to a nice lunch, but can’t find the exit. Soon he is somebody else’s lunch. You have to plan your exit strategy! If you can’t plan your way back, it may not be safe.

I don’t ever recall being caught in (or near) such a fine lobster trap as yours. But you have to get suspicious when there are no proper landmarks or permanent signs. In some Japanese cities, where you want to be is not obvious, not to mention Sao Paulo or Los Angeles. But I’m careful to buy a good map.

I’m with you: there are some places that are inherently dangerous in the wrong conditions. You have to recognize them before you get too far in.

Comments invited.

/ rap

Bob (if I may),

I have just read your column in the 3/10/11 issue of *Electronic Design* and I want to add my voice in strong support of the diverse nature of your subjects, including the current piece on hiking (see “What’s All This Small Hiker Stuff, Anyhow?” <http://electronicdesign.com/article/analog-and-mixed-signal/What-s-All-This-Small-Hiker-Stuff-Anyhow.aspx>.) I fully share your belief that it takes much more than an engineering focus and background to make a strong, creative, and worthwhile contribution to the development of modern electronic technology and systems. **(Fair enough. /rap)**

Personally, I have experienced this path throughout my own career. I am trained as a physicist (teaches one “how to think”) **(I was in Course VIII Physics at MIT for three-and-a-half years before transferring into EE (Course VI). /rap)**, and I obtained my “engineering” expertise and background beginning from age 13 in 1955 with my experiences as a ham and continuing to this day (I never took a single engineering course), and I have used these skills to manage large, sophisticated engineering teams and companies, especially in satellite telecommunications.

(Wow. Without going to an accredited engineering school, you seem to have figured out a lot of good engineering. I guess the UNH (College of Hard Knocks) still works well. Some of the best engineers I know didn’t go a full year at good engineering schools. /rap)

Of course, I appreciate and benefit from the common sense technical advice offered by your column, but I find your columns on non-engineering matters to be equally valuable as they illustrate successful and diverse living, a trait I believe necessary for success in the engineering business.

So here’s a vote for more columns like the one on 3/10/11. Keep it up. Your column is the first thing I read in every issue of the magazine.

Best regards,

James “Buzz” Beitchman

PS: Of course, I’ve been a *Trains Magazine* subscriber since 1961.

Dear James,

Thank you.

It takes quite a bit of planning and engineering to plan good hiking and camping for kids. It’s very educational for parents to do this planning.

Thanks for the kind words.

Beast regrds.

/ rap

Hi Bob,

We’ve communicated and met several times through the years. I’ve always enjoyed your responses, tutorials, and columns. This time you really outdid yourself. I am sitting here at my screen, literally laughing out loud. Not just because of the humor and your colorful expressions (“Fornicate that!” indeed!), but some of the things you say are exactly what I have said in the past. (I’m happy to see that *Electronic Design* was brave enough to publish your words.) **(Thanks for your words of support! Better that we should fornicate bad cars before they fornicate us! /rap)**

I thoroughly enjoyed your response to the young analog designer wannabe from India (see “Bob’s Mailbox: Advice To A Young Engineer, Julie Resistors, Key-Less Acceleration, And Hiking with Kids” <http://electronicdesign.com/article/analog-and-mixed-signal/Bob-s-Mailbox-Advice-To-A-Young-Engineer-Julie-Resistors-Key-Less-Acceleration-And-Hiking-with-Kids.aspx>). I somehow doubt he will ever make the grade and will end up staying in the software world. If he didn’t already have analog design in his blood, or just by tinkering in it since he was a young pup, then I doubt he ever will.

(I told him the best way for him to become a real analog man was to go back on a time machine and buy 10 Heathkits (and I told him what types), build them, and get them running right, and to meet all the people you meet when you build radios, tuners, amplifiers, voltmeters, etc. Since Heathkits and time

machines are almost equally hard to find, obviously I was just saying he had taken the wrong fork in the road, and was also born too late, and maybe in the wrong neighborhood.

Can you imagine a farmer's kid in India 30 or 40 years ago trying to save up enough rupees to buy a kit for a Heathkit tuner? My first Knightkit cost me \$26 in 1957, and I still use parts of it. (And my father was a farmer, and not a rich one. But he did have a car, an old pick-up truck, and a tractor...) /rap)

Perhaps even as much, I loved your comments on the unintended acceleration (UA). I too am of the old school of automotive control. As I now have hit Social Security (if it still exists anymore) age, I can proudly admit I have never owned a car with an automatic transmission or one of those silly push start/stop buttons. I want to have control over the machine that can readily mean life or death for myself and others around me. Even my brand new Subaru Outback has a real key and a manual transmission. I had to wait months for this to come in, as perhaps only a few percent have the manual! From the beginning of the push-button "ignition key" design, I thought it to be a bad idea. Why a push-button? Is it so difficult for a user to operate a key or perhaps even a simple toggle switch?

Unnecessary technology—bah, humbug!

Rick

Hello Rick,

Amen! I'm with you on all that. I agree, life-or-death decisions will be made by me, and not by some damn computer the car maker dumps on us. My wife went out and specifically bought a RAV4 with a stick-shift, which she prefers for all those reasons. And it's a pretty darned good car.

Beast regrds.

/rap

P.S. The number of people who (in the case of UA) just want to shift into neutral and let it rev is amazing. They don't want to turn off the key. They don't even understand that if your engine is screaming with wide-open throttle, your wish for power brakes may fail as there's no manifold vacuum. Damn fool idiots... Where did they go to school? The University of Namby Pamby?

What's All This Floobydust Stuff, Anyway? (Part 15)



April 19, 2011 03:52 PM
Electronic Design
Bob Pease

I needed some drills smaller than 1/16 in. diameter, such as #66 at 0.033 in. diameter, for 1/4-W resistor leads. These are defined at sizes of #1 to #80, per http://en.wikipedia.org/wiki/Drill_bit_sizes. Even the best hardware stores said, "WHAT?" I tried 10 hardware stores and found none. This was annoying because I needed several.

Finally I got smart and went down to my neighborhood hobby store, Franciscan Hobbies at 1920 Ocean Avenue, San Francisco, Calif. 94127. The store had them at a price of \$1.50, including tax. It would be silly to buy fewer than five or 10. These little guys can break. So send a SASE with 88 cents postage, and they'll be happy to sell and send you some.

Sizes range from just slightly smaller than 1/16 in. to #66 at 0.033 in. to #80 at 0.0135 in. diameter. Drill sizes between #1 and #52 are roughly covered by ordinary fractional-inch drill sizes from 1/16 in. to 1/4 in. But as there are 52 drill sizes, there may be better fits for your needs.

Nuclear "Dangers"

I have been studying this nuclear radiation confusion. Some stories show a wide range between eating a banana and getting badly hurt by radiation but neglect to point out that this range represents a factor of hundreds of thousands in ratio.

It seems they're preaching to people who cannot understand four or five orders of magnitude. They can't comprehend a log scale. Then we hear of radiation detected by very sensitive instruments, even thousands of miles away. These amounts can be another factor of 10,000 further down. Bring me some of that radioactive spinach from northern Japan. I'd love to buy and eat some!

Dirty Dishes, Daddy Do?

A few months ago, I noticed that my dishes weren't coming out washed clean from my fairly new KitchenAid dishwasher. I called the company's service branch, which sent out a repairman. He did some nominal cleaning and sold me a couple bottles of snake oil to rinse it out with. There was no real improvement. Ahem?

It turns out, many soap-makers have recently reformulated their soap to cut out the phosphates. We don't know for sure what they put in instead, but the dishes don't wash clean. If you like to wash all your dishes by hand, so they are clean when you put them in the dishwasher, be my guest.

It's true that if your local grey water winds up in lakes or rivers, it is a good idea to cut down on phosphates, which can gum up the environment. My grey water flows into the ocean, and I don't give a hoot! But don't waste \$150 on a "service call" that will do you no good, because nobody else (except rap) is talking about the real problem—the inferior soap. Let me know if you find some good soap.

Soldering to SOT-23s... Wicked Wires

I had to solder up a small surface-mount IC and didn't have the best of tools. I tried for a half hour to connect to the five leads of an SOT-23, and the wires didn't want to wick the solder properly, no matter what wire I tried.

Finally I took some #22 stranded wire, stripped off 1/3 in., and cut off all the strands but three. To my surprise, these three strands wicked up the solder beautifully, and it took only a couple minutes to solder to the SOT-23-5.

Steering Locks Up?

Has anybody actually seen any car where the steering locks up when you just turn the key left (CCW)? Make, model, year? Test for this in an empty parking lot. Nobody yet has told me of any car that locks the steering if you don't pull the key out.

Unintended DEceleration

Some people are afraid of turning off the key when they are driving, because their car would be hard to steer or brake without power brakes. Well, what if a hose falls off, or a wire, and the engine dies? What if they run out of gas? They really ought to check out how it feels to drive on a road in this condition.

What if you're on a highway and run out of gas in the fast lane? You'll start slowing down gradually. What if the driver behind you doesn't notice this? Reach over and blink your taillights ON and OFF to wake up the guy behind you.

As mentioned recently, just shifting into neutral to cut off unintended acceleration may not work well, as a wide-open throttle may cause loss of manifold vacuum and loss of power brakes. Turning off the key still works better.

Airport Thieves

I had some Valuable blue pills stolen out of my checked baggage recently. Apparently they light up like a Christmas tree when X-rayed. Some thieves have been caught at various airports, but not all. Carry your Valuable pills in your carry-on baggage to minimize the risk of losing them.

How to Change Your Audio Amplifier Distortion

Recently I heard of some \$85 modules that are supposed to improve your amplifier's distortion and lower its input noise too. A guy tested out a couple and found the distortion was changed. It got worse, and the noise, too. Don't be fooled by absurd claims.



Bob's Mailbox: Hydraulic Rams, Old Car Radios, And 5-MHz Power



May 05, 2011 02:56 PM
Electronic Design
Bob Pease

Hello Robert,

On the stuff below (see *"What's All This Hydraulic Ram Stuff, Anyhow?"*), I see a lot of reference to switching, oscillating, etc.

A few times over the past 40+ years, I have had to get involved with customers who have had their applications slowly fade into the sunset (gradually reduced dynamic performance) and eventually quit working. The period of time involved was typically several days to several months after operating and meeting full dynamic expectations within their applications. When I got back the parts involved, their HFEs, particularly on the left side of beta peak, always had HFE-vrs-IC slopes that were three to eight times steeper than they should be in that region.

Thus, if they were using the parts queued up at a significantly lower average than where the peak HFE occurs (common in some switching power-supply and in most oscillator and other class-C operations), the HFE had "degraded" to the point (with the slope change involved) where the transistor would not queue up at the originally intended operating point any longer. This often becomes a problem first noticeable in relatively cold operating environments because that "much poorer slope" on the left side of HFE peak also flops around in the breeze more than normal vrs T_a (and/or T_j).

The problem always came back to being caused by very short but repetitive duration (usually at the working frequency or, occasionally, at the third upper harmonic if RF was involved) barely exceeding the actual BVEBO threshold of the transistor involved during the transistor-off portion of the full-cycle operating time period. In these instances, when passive component value changes were made around the part to ensure these short duration peak voltages were kept below the device BVEBO, the functions never encountered the problem again.

I don't know if this is what is causing the problems being outlined or not, but it wouldn't surprise me if I'm understanding and interpreting the circumstances being described correctly.

Until recently, I ran into this problem most often in RF multiplier applications, but I am seeing it more often now in some of the bipolars used as drivers in higher-speed (PWM rate) MOSFET power-supply/converter applications. I am also encountering more recently in bipolars used as outputs, particularly in low voltage (<10- to 15-V dc inputs), in power supplies/converters as designers try to reduce system and component costs or reduce space by taking the transistors closer to "the edge" than in the past and milking them for everything they're supposedly capable of. The problem is that people can look for this situation and/or limitation (violation?) as part of a design evaluation, but instrumentation used can load down the applicable feedback loop equations such that the loop intensity then momentarily decreases enough that everything looks okay across the emitter-base junction during the "off" portion of the device operation. And the higher the frequency goes, the more apt that the potential problem will be missed.

The BVEBO ranges of devices with similar FTs and intended to be used in similar function segments and/or families will also tend to have similar BVEBO ranges. I've run into a few exceptions but they are not common, so it probably wouldn't much matter whose device was involved if this is what is going on.

Regards,

Gus

Hello Gus,

Here's a pretty good technical answer.

If you had asked me how to degrade beta, I'd have said, "Zenering the Vbes." Well, my old friend Gus had already put two and two together. Here's what he said: He never distinguished between NPNs and PNPs, so you ought to protect your PNPs, too. In my LM331 circuit, the leakages at room temp were negligible, but a PNP junction that leaks a few pA at room temp could leak many nA when hot. I put in a diode to clamp that current and not let it zener the NPN. It seems (33 years later) to have worked well. But when the datasheet says "Do not exceed absolute max ratings," such as V_{be} , I guess they really do mean it!

/rap

Dear Mr. Pease:

Your essay on the hydraulic ram brought back a memory. During the summer of 1950, between my freshman and sophomore years in college, I took a job at a steel mill, with the bricklayer gang on the open-hearth floor. Molten pig iron from the blast furnaces would come to the floor in huge ladles. It would be poured into the open-hearth furnaces to be converted into steel. I would watch the glowing particles of molten iron that fountained up, like fireworks, from whatever the iron was being poured into. The particles would shoot up higher than the ladle. I always figured it was some surface-tension effect, but never really investigated it. I hadn't thought about the phenomenon in years until your article triggered the recollection.

(I expect that any moisture could cause what you saw. Obviously, those molds that the hot iron was poured into, even with a 0.1% amount of residual moisture, could make enough expanding steam to cause what you saw. If you had a mold for pig iron, and you baked it even at 240°C, that might cut down the fountain of sparks, because the moisture would be baked out. But most of the time, nobody cares. Even if it weren't water, it could be any other substance that could expand when highly heated. If these were molds made of sand and they worked okay, nobody would ever worry about this. Do you have any idea how these molds were made? Who made them? What was the formula for the sand that went into them? /rap)

I always enjoy your essays in *Electronic Design*. They are one of the first things I turn to, before I dig into the technical articles.

Joseph P. Martino

Hello, Joseph M.,

Thanks for writing. Good question!

Beast regards.

/rap

Bob,

I really appreciated your article about hydraulic rams. As a kid, the first experience was magic, but after a few minutes it was clear how it worked. It was also clear that the noise and leaks were not efficient and the process could be better. I have probably been borderline obsessive about efficiency ever since. **(I'm in favor of efficiency—if it doesn't drive me nuts!! /rap)**

This led to engineering school, small hydroelectric (2 MW) projects in the Sierras, and generators and power application engineering of many kinds. Now my son is also a power systems engineer. He was infected early on.

In case you missed this interesting article in *Machine Design*: <http://beta.machinedesign.com/article/more-efficient-pressure-regulator-cuts-operating-costs-1117>

(Are you sure this idea is going to work? I have got to say, I am skeptical. An electronic switcher doesn't just have two terminals. It normally has three. If you want to put out 1 A into a 5-V output, you can put in an average of 0.5 A at 11 V, and the other half-amp comes from ground. This guy's switch really doesn't look like he can do that. It will take me a while, but I think this guy Alfred Perz's idea is bogus. I have got to study this some more. I'll be back. Hey, ask your son if this will work. /rap)

We deal with natural gas compressors that consume huge amounts of power. Often it is possible to greatly reduce the power consumption by changing process strategy. I have been looking for an application of this guy's strategy for a year. Someday I will find one.

I look forward to your columns.

John Carroll

Hello, John Carroll,

I think it won't work. If he built it and measured the input power, and the output, and he thinks it is efficient, I think his measurements are wrong!

If you put in 10 lb of air at 100 psi and draw out 10 lb of air at 40 psi, you still have to put in a lot of energy. He is a bit overwhelmed by the thought of dealing with millions of cubic feet per day, instead of the workstation rate of consumption he discusses. I don't think this will work for small or large applications.

If you run a turbine off the 60-psi pressure difference and use that energy to pump more air, you can get 10 lb of air out at 40 psi, with perhaps 6 lb of air at 100 psi, because the pump can compress 4 lb of air from the atmosphere. That is how a switcher works, and not like Perz says. His will still waste power.

Beast regrds.

/rap

Dear Mr. Pease,

I have been reading your column for years and enjoy it immensely. My first paying job in electronics was at Thompson Radio & Television Service in San Antonio, Texas.

In 1968, my junior year in high school, Mr. Thompson put me to work after school and on weekends fixing car radios. They had about five to seven tubes and a vibrator for the plate voltage. Tuning was mechanical: a gear and worm moved ferrite rods in/out of coils for each channel assigned to a key. Then you pulled the key out, tuned the desired channel, and then pushed the key back in to set the frequency. A trimmer cap adjacent to the antenna connector was adjusted for best overall band response (matching). **(That sounds about right, even though I never fooled around with them. /rap)**

I have been privileged to work on a few of these lately for antique car buffs. When the vibrators quit, you can buy a solid-state replacement but that's no fun. I like to fix the old ones. I cut notches around the bottom edge of the can with a pair of sharp side cutters, peel the edge back to remove the vibrator, and then polish the contacts with 600-grit wet/dry sandpaper and Caig De-Oxit. I then bend the edge back over and coat the seam with RTV. It's more original that way.

Often there is no visible sign of pitting or burning on the contacts. They just develop a high resistance. My friend the chemist tells me that the rubber used to wrap the inside of the can out-gasses over time and leaves an invisible insulating film on the points. I'll just have to take his word for it. I miss the "good old days" when a technician knew how to sweep an IF.

Best Regards,

Your Obedient Servant In This and All Things

Tom Treadway

GT Communications

Hello Tom T.,

Since this radio takes so much work to open up and get inside, I think the solid-state version would sound good to me, if I just want a radio that runs. However, I do understand "old-car buffs" who like to have everything as original and authentic as possible, no matter what the trouble or expense. But, I am in favor of rehabilitating the old ones. In general, I do like to repair old things, not just junk them.

Thanks for explaining how you do it. I really do like to take old things apart to see how they worked, see how they failed, and see if they can be repaired. I'm sure if I had one of those old vibrators, I'd pull it apart. But I never got into this old radio stuff. I'm sure there are things that are not easy to repair.

I have an old Harman-Kardon Stereo Festival 5000 and I had to replace its caps when I bought it. I may have to do it again.

Hey, old Sidney Harman just died at ~ 94? And you can even "google" him up.

Beast regrds.

/rap

Hi Bob,

I enjoyed your column in the March 24, 2011 issue of *Electronic Design* on "What's All This George A. Philbrick Stuff, Anyhow?".

A hundred years ago there was considerable discussion about what frequency to use for electrical power. Edison preferred dc because it made some things simple, although it required MG sets where we now use transformers. **(Uh, yeah. /rap)** Fortunately, most people saw the advantages of ac **(Well, it took old Nick Tesla to invent good ac motors. /rap)** and it was only a question of what frequency.

Higher frequencies meant smaller transformers (less iron), but greater problems due to line inductance. Lower frequencies meant not only bigger transformers but bigger motors and generators, for a given power, because of an inherent speed limit on machines since power is torque times speed. For example, at 25 Hz the maximum speed of a synchronous machine (or near synchronous induction motor) is 1500 rpm. At 60 Hz it's 3600 rpm. **(Yeah, but 25 Hz is still used for some trains... /rap)**

At high frequencies, in addition to the problems you mentioned, I would think one of the biggest problems would be transmission stability. Even at 60 Hz, transmission stability runs into problems when the line length starts being a significant fraction of a wavelength. For a 1000-km line, the line end phase difference due to this effect alone is 72° , which is a problem right there unless it's properly handled. At 60 kHz the same issues would apply at only 1 km, and at 5 MHz they'd be horrendous. **(Not to mention skin effect. /rap)**

I could see going to radio frequencies, at least in principle, for short-haul situations like downtown areas, but you'd need frequency converters (to 60 Hz, say, or even dc) when transmitting for anything like a kilometer or more. **(I think George was just playing games. /rap)**

Taking into account all the pros and cons, most of the world quickly settled on 50 to 60 Hz as the best compromise, although there are pockets such as Toronto, where I live, where 25 Hz and even dc persisted until around the 1950s. **(In some parts of Boston, some old dc power continued into the 60's. /rap)**

Cheers

Tony Griffin, P. Eng.

Tony,

Have you heard about the fiasco in Japan? Most of the east coast is on a 50-Hz grid and the west is on a 60-Hz grid, and as F-converters are so expensive, there are very few of them. So now the east is power-starved and cannot borrow much from the west! My goodness!

/rap



What's All This Pre-Diabetes Stuff, Anyhow? (Self-Doctoring, Part 6)



May 16, 2011 09:12 AM
Electronic Design
Bob Pease

About 16 years ago, my doctor told me I ought to cut back on sugar, because my blood sugar was getting up a little high. So I did. However, after a few years, I became diabetic anyhow. I was always curious what I could have done to avoid getting diabetes. I mean, even though diabetes is not the worst disease you could ever have, it's still not fun.

Recently I heard a radio program where the lecturer had a very heavy accent. But by listening very closely, I figured out that "pre-diabetic" people had some choices to make to avoid becoming diabetic. But that's not exactly what my doctors told me 16 years ago. I'm still trying to research what people should do—and what I should have done.

First of all, the old term my doctor used was "insufficient glucose tolerance." This is not exactly helpful to most people who are not skilled at "doctor-speak." So the medical community has dropped this phrase in favor of "pre-diabetic," which is much clearer to the patient. This is especially important because there are so many overweight people who are pre-diabetic. (If your family history or genetics has diabetes, you could become diabetic without being overweight, but the smart money is on fat people to become pre-diabetic.)

Good Advice

If I would have had the full advantage of a modern pre-diabetic program, I would have been taught a complete program of what to do to avoid becoming fully diabetic. I was just warned to cut down on sugar consumption—fine—but was not taught any of the other parts. This would really be quite similar to what diabetic patients are told: to minimize the chances for getting diabetes, follow the advice for people who are diabetic. You might be able to back away from the problem:

- Lose weight. Weight is a big part of the problem.
- Get more exercise, most days a week. Don't just sit down most of the day.
- Cut down on all carbohydrates: sugar, starch, bread, rice, potatoes, pasta, etc. Avoid overeating.
- Take it easy on the milk and yogurt and sweet fruit.

At that time I was slightly overweight, but I had good, strong (heavy) legs for strong hiking. I got good exercise with one hike each weekend, but not much during the week. This is not as good as keeping active all day, but most of us ain't farmers, and that's not easy. And I sure did like eating a lot of rice, potatoes, and seven kinds of pasta. These foods can push up your blood sugar just like sugar, except eating a lot of rice or pasta is not normally associated with a bad diet.

So I didn't do a very good job of keeping my blood-sugar level down. And that made my "glucose tolerance" even worse, and my insulin output even worse, and there I went down the slippery slope. I have been taking various drugs to keep my blood-sugar level a little lower, and it is coming down.

If you are overweight, you may not exactly have to ask your doctor "Am I pre-diabetic?" You may be able to figure it out for yourself. Does your doctor ever screen you for blood sugar? Even if your blood sugar is not terribly high, you should consider this as a caution or a warning to avoid a diet that just pushes the blood sugar higher until you get in trouble. Is frequent urination or unexplained tiredness a problem?

Testing And Planning

There's another test that most non-diabetic people don't know about—the "A1c" test. It works like a three-month running-average blood-sugar test. If you ate very little starch or carbohydrates or sugar, six days a week, but binged on them one day of the week, you might pass a spot test, but your A1c would take the average of all those readings. So this test might give you a better warning. It's the average that's bad for you, and the A1c does respond to this average.

If you are told that you may be pre-diabetic, you should probably start on a diet very much like a diabetic person. This is not really any extreme diet, but a good, healthful balanced diet, with not too much carbohydrates (starches). That means not just cutting down on sugar, but also cutting back on large amounts of other carbohydrates such as potatoes, rice, bread, pasta, and other kinds of starch. Eat more veggies, etc.

You certainly don't need to cut out carbs. That would be wrong. Just stop pigging out. (That's a technical term that my doctor never used on me.) And cutting down on the carbs will also help you get your weight down, which is the other important thing. And, exercise a lot, as much as you can.

Then you might discuss this with your doctor, or with the nutritionist your doctor works with or recommends. You might also bring in your spouse to get the idea of what kind of cooking and diet will help you the most. Starving yourself for one meal and binging on the next meal is probably a bad idea.

My doctor did (16 years ago) warn me about cutting down on sugar, but not about the other carbohydrates. I don't think he talked about the weight loss or the exercise.

So I'm smarter than I used to be. And my doctor is smarter than he used to be. And so are you! You have to help your doctors to process the raw data (how you feel good, or lousy). You may be the best observer of this data—and the best person to interpret it so your doctor can help you do the right thing.

What's All This 4-To-20 mA Stuff, Anyway?



June 09, 2011 08:42 AM 6/23/2011
Electronic Design
Bob Pease

About 30 years ago, some guy told me he had a 4-to-20 mA current source. He wished he could tell if the current was out of range—or if the wire was broken! But nobody could tell him how to detect this. Well, if you want to wave a red flag in front of a bull, just tell me that there's an analog function and nobody knows how to do it. So I began to figure. How can we tell if a 4.0-mA current shifts down to 3.70 mA or less? If we could tell that, that would be an illegal condition.

I decided to use Bob Widlar's new LM10, which incorporates a voltage reference and an op amp. Surely I could invent a trick circuit to detect and transmit the error when the current gets too small. I sketched and fiddled and invented a circuit that worked. The customer agreed that it worked.

I also submitted this as a sort of "Idea for Design" to one of the instrument and industrial magazines, because we knew its readers always used a lot of "4-to-20 mA." So the magazine published that circuit. About three months later, we got a nice letter in AWE, because the reader response to this little circuit had drawn more interest than the magazine had ever seen before. Well, I guess so.

These days, the LM10 is still made and sold, but at \$2.30, it's a little more expensive than you really need for such a simple function. When we brought out the inexpensive (37 cents in quantity) LM4041-ADJ, I figured, "That ought to be able to do it, too." The LM4041-ADJ has a little gain stage and a 1.2-V reference, so it will perform those functions (see the figure).

Key Specs

The 4N28 has fairly mediocre gain (0.1 to 0.3), but it's adequate to put out a little flag that can be detected down near "ground." The LM4041-ADJ detects the 4.0-mA current through the 332 Ω and turns on the 4N28. If that current drops below 3.7 mA, the LM4041 turns the opto off. Even a simple circuit can perform a very useful function. You don't have to try to find a 30-year-old magazine.

If you want to check the actual level at which this circuit trips and detects, you'll want a little triangle-wave tester to put in calibrated currents both above and below 3.7 mA. If the output duty cycle is exactly 50%, you'll know that the threshold is correct. You could trim if you wanted better than 2% accuracy.

I used to work for Teledyne, and if you know your Greek, you'll know it means "distance and force." Well, this circuit puts out a small force even isolated hundreds of volts distant, above or below ground. No galvanic connections. So, isolation does not mean poor accuracy or great expense.

Dirty Dishes, Daddy Do? Part 2

My recent column on dirty dishes (May 5, p. 104) prompted a lot of mail from readers with similar complaints, including my brother-in-law Alan Tausch, who had figured out the problem pretty well:

Hi Bob,

I just read your column, and I was very interested in your section about dishwasher soap. Your column is so far the only place where I have seen this issue brought out in print. I went through the same frustration recently. The dishwasher that worked fine for years suddenly no longer gets the dishes clean. Besides that, the glasses are starting to come out with a white haze on them, which cannot be removed with any solvent I've found so far. The only solution has been to throw out the glasses and buy new ones. We even bought a new dishwasher, thinking the old one was not working right any more—and got no improvement with the new one.

Then I learned about phosphates being banned from dishwasher soap. And frankly, I'm livid. It's a prime example of overreaching government intrusion. But what's worse, they apparently decided to do it without publicizing it. Yes, if you do a search on the Internet, you will find articles saying that phosphates were banned. But I do not remember ever seeing anything in the news that it had been decided and was about to happen. Was this a liberal/government/media/conspiracy? Well it sure does look like it.

Anyway, here is the solution. Go to your hardware store and buy a box of tri-sodium phosphate (TSP), the same stuff you'd use for cleaning your deck or other tough outside cleaning jobs. Put a teaspoon of the TSP into the little soap compartment of the dishwasher, along with the soap gel for each load.

And, by the way, if you go to the appliance store and say your dishwasher doesn't seem to be working well and you want to buy a new one, they will be happy to sell you one, but they don't mention that the reason your dishes aren't coming clean is the phosphates. Do even the appliance sales people not know? Or do they just want the commission on the sale?

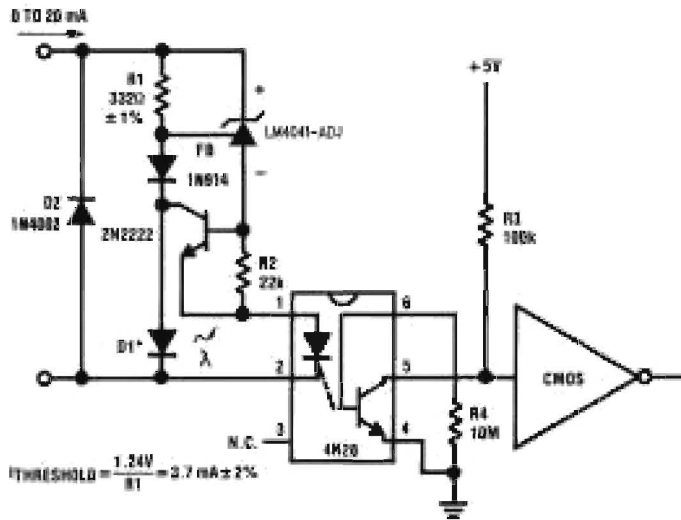

What's All This Solo Hiking Stuff, Anyway?



June 16, 2011 10:53 AM 7/7/2011
Electronic Design
Bob Pease

I got an e-mail the other day from a friend in a hiking group: "Bob, what do you think of this?" As I read it, I immediately saw red, or at least orange.

The writer observed that "You should always hike in a minimum group of four: if one person gets hurt, one person can stay with him, and two can go for help." Well, it is true that this a fairly safe way to do it. In the winter, it's definitely a safer, recommended way to go. And usually a group of four can be nice and sociable.

But that tends to discount the joys of solo hiking. Admittedly, going for a duo hike with a (girl) (boy) friend isn't as safe as when you bring others along. (Well, duh.) However, always going in the safest possible way can get pretty boring, concentrating on "safety first" first and enjoying the hike last.

Sometimes not going on a hike at all can be safer than going out in a group of two, three, four, five, n... as we will recall from some hikes. And sometimes it took a group of three or four just to go safely to the john.

Some Solo Tips

If you're going to do solo hiking, you have to hike pretty carefully, in a responsible way. You have to be pretty careful to not screw up or fall. Don't trip or goof off, much.

Let people know where you are going. If you are leaving your car for a few days of solo backpacking or several hours of solo hiking, tell a good friend (or family member) when and where you are going and where you are leaving your car—and tell them after you get out!

Of course, if you are going to do solo hiking, there are many possible problems. If you get hurt, it might be many hours before your friends (or family) even start looking for you. How cold will you be by then? How worried will your friends be?!

One of my friends says he tells his family, "If I'm not home on time, don't send a search party out for me at night and search around like idiots and get hurt. Wait until morning." Smart cookie. Thoughtful cookie.

Duo hiking is fun. I have done a lot of hiking with my wife. We have done many hours and miles, duo hiking and backpacking. Many miles from the nearest road or civilization. Many hundreds of hours. Maybe 2000? Maybe more (see "What's All This Small Hiker Stuff, Anyway?" March 10, p. 80).

But if one person gets hurt, a duo hike can turn into a solo hike, when one person goes for help. I've never had to do that, but of course I have to be prepared to, and so does my wife!

But solo hiking can be a real adventure. You don't know what you'll find. That's one of the nice things of a random solo "day hike," which can be different from a well-planned day hike, which can be fun, too. You can also tackle routes that would be too hard for another person. Or too easy, or too boring, or too slow, or too fast....

Bring water. Bring water purifying pills. A little food. Enough warm clothes (and a sleeping bag in winter). Bring a whistle. And, bring a watch.

Now, why would you want to bring a watch and spoil the unplanned, un-organized fun of a spontaneous hike? One serious reason: So you know when to turn around! You need to plan when to turn around and not fudge this time very much.

Normally, you want to leave as much time for returning as going out, because you may be tired coming back. But when I hiked west of Dughla, I presumed I could safely come down 1.2 times faster than going up, because at 16,000 feet, you know you'll be slowed down on the uphill, so you can descend on a good trail faster, yet without hurrying. Hurrying is the thing to avoid. Or getting tired.

Take A Hike!

Here are some of the good reasons to go solo hiking:

- For fun, or for daring, or at least the feeling of daring.
- For solitude.
- To get away from the group. Get away from “group-think” and the overwhelming rut of “safety first,” even though you have to be more careful than usual when hiking solo. (Kinda backwards, ain’t it?!)
- To get snow for ice cream—or Jello. Warm Jello can be fun, but cold Jello on a summer camping trip is festive! You don’t need two people to get a bucket of snow. I’ve done this several times.
- Find: what? One nice thing of solo hiking is that you often get to find something you didn’t know was there. A nice little surprise?
- Find a nice lookout on a ridge? Valley? Follow a stream? Random cross-country hiking? See wild animals?
- One of the best things is not really knowing where you are going. Maybe there’s no trail. Serendipity.

RAP’s Favorite Hikes

I’ve been on my share of some good, interesting solo hikes.

When we went to the Khumbu (Everest) region in 2000, simply getting from one camp to the next, from Lukla to Namche to Gorak Shep, required 29,000 feet of rise and fall in 33 days. In addition to this, I went on day hikes most every afternoon, and they added up to another 29,000 feet of rise and fall in 30 days, too.

One of these day hikes was from Dughla west. Dughla is a few miles south of Gorak Shep. I went up a few thousand feet on a rarely used trail, past Dzhong La and toward the high pass at Tsho La. And I got back in time for supper. I think I saw three people, all afternoon (see “What’s All This Trust Stuff, Anyhow?” at www.electronicdesign.com).

Mostly, I did not go on this hike solo. But it did feel like it was solo, because SalaamSing let me lead, as if I knew what I was doing! And he left me solo the last hour. We didn’t see other people for five hours. Only seven yaks. Is that close to solitude?

Two days earlier, I hiked returning from Everest Base Camp (EBC). Going up to EBC, I went with Puri Rai, a pleasant young Nepali porter. But on the way back, he trusted me to hike on my own for about six miles and three hours, all the way back to Gorak Shep and Lobuche. I got to Lobuche in time for early soup, as the sun was setting.

Then, there are the Falls of the Little Bighorn stream. When I was seven years old, I went off for a few hours, following the local brook that started behind my house, down to the Falls and to the Scantic River. I was never more than a third of a mile from roads. I studied the map later.

I also traced out Creamery Brook, near my house, up to its source. But for some odd reason I never traced out much of Broad Brook stream. Neither above, below, nor beside our village. Not sure why not.

Lassen Park has some good hiking. I went up to get snow, a mile off the trails. I waved my arm, “Nancy, I’m going to go up—there!” I came back with snow, in a couple hours, just fine. No hurrying.

I had another good hike with Joan B. above Crown Lake above Bridgeport, Calif. Duo, not solo, but this hike had all the other features.

We had no idea if the route would go through. There was definitely no sign of a trail. We hiked up a cleft and clambered over easy slabs. We were really very doubtful that it would go through, so we had to be prepared to wend our way back on a couple miles of tortuous route. And our buddies had no idea where we were. Holy cow, we had no idea where we were! But a mile later, we saw that it would go through to an easy descent. No hurrying.

Aliwal West? Barkley North? In South Africa, I hiked for a few miles along old abandoned railroad tracks. I saw no wild animals. I don’t know what I would have done if I had.

I took a train up to Mysore, west of Bangalore, India. Would Mysore be like Crawford Notch, with steep mountains above? Not at all. It’s a broad, shallow valley. I hiked through the small city of Mysore, past the Sultan’s Palace, and a couple miles on country roads, and then up a big hill with 1070 steps. I think all day, I saw four people and one elephant. But at the top there were hundreds of people—pilgrims.

Nancy and I hiked the Mahoosucs, which is northeast of Gorham, N.H., opposite from Mt. Washington, which is southwest of Gorham. We hiked duo all day for five days and didn’t see two people. Yes, we were on a trail, but nobody else was. This was back in 1962, when hiking was not so busy. This was the through Appalachian Trail, and there was still nobody out there.

Malcolm and I tried to do the Mahoosucs duo in 1966: 24 miles in one day, starting at 4 a.m. We started out on a schedule okay, averaging 2.5 mph, up and down Old Spec. We then slowed down for Mahoosuc Notch and never were able to get up to speed again.

This trail had well over 10,000 feet of ascent and descent for one day. We really did try to get in shape for it, but as we saw that we were falling off our schedule, we crumpled out after 12 miles and went out eight miles on an easy side trail. We had one small pack, and one of us carried it uphill, and one down. We never saw anybody all day.

At Mt. Pickering in winter, Nancy was impaled by a snag, more than two miles from the road. This is the kind of near-emergency that you want to avoid by hiking in groups of four. But she didn't bleed much, and we walked out okay.

Del Valle near Livermore, Calif., was a solo hike, 5500 feet up and down, up to Joaquin Murieta Falls. It would have been less of (ascent + descent) if I'd kept going the whole 24 miles to Sunol, but I had no car over there! So I went back to my car. No people that day. The waterfall was nice. It only flows on rainy days. A permit is required.

So I hope all you good hikers will have some fun with solo hiking, because if you are careful and responsible, you can do some wonderful hiking.

Footnote: "SPOT"

A friend of mine who does a LOT of Solo Hiking recommends:

Bob, Here's a link for the SPOT satellite messaging system

<http://www.findmespot.com/en/>

For \$100/year it's worth the peace of mind when you're out –solo or not. It works great: I can check in with an "I'm OK" message every night, get family assistance, or SAR (Search and Rescue) if I really need it. Their new system allows you to send text messages when paired with a cellphone. I'd rather not drag along a cell phone so I just set up smart pre-determined messages to send out.

Cheers, / Alan S.



Bob Pease Remembered For Pease Porridge And A Whole Lot More

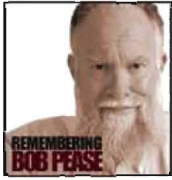

June 20, 2011 04:33 AM 7/7/2011
Electronic Design
Joseph Desposito

It was late on Father's Day, around 11:55 p.m., when I finally got around to writing my editorial for this issue, which was due the next day. I had some ideas of what I wanted to write about and was busy gathering information. One piece of information I needed was in an e-mail I had received a couple of weeks ago, so I launched Microsoft Outlook.

Rather than going straight to the e-mail I needed, I started skimming the e-mails that had come in over the weekend. The first one I came across was a notice that my niece had wished me a happy Father's Day in a Facebook post. I clicked on the link, got on Facebook, and sent a reply. Then I went back to Outlook and continued skimming the e-mails. One subject line stopped me cold. It said, "Bob Pease Killed in Car Crash." I read it in stunned disbelief. I looked at the sender: Paul Rako, the analog editor from *EDN*. It must be true, I thought. Horrible news, but true.

In part, Paul said that Bob was killed when his car left the road as he drove from Jim Williams' memorial service yesterday. It's doubly unfortunate that two of the greatest analog minds in the business passed in the same week. As it was earlier on the West Coast, Don Tuite was online and sending e-mails to our staff. He sent a link to a *San Jose Mercury News* article: "Driver, 70, Dies in Saratoga Crash."

The short article stated all the facts: A 70-year-old San Francisco man was killed after his car hit a tree in Saratoga on Saturday evening, according to the California Highway Patrol. The man was traveling eastbound on Pierce Road at an unknown speed when he failed to negotiate a curve to the left at about 5:45 p.m. The driver's 1969 Volkswagen Beetle veered to the right off of the roadway and crashed into a large tree on the right shoulder. The man was not wearing his seatbelt and it appears he was killed instantly.

Everyone who reads Pease Porridge knows that Bob drove a 1969 Beetle. Bob brought it up many times over the years and just recently in a popular column about unintended acceleration. Everyone knew this because Bob was unrivaled as a columnist in this industry. Though he was certainly an analog guru who could write about the nuances of a very difficult subject area, he also talked about everyday (and not so everyday) life situations.

Bob told me many times that his column was about thinking. Whenever he tackled a topic, he essentially welcomed readers into a dialogue about how to properly think about that topic, at least from Bob's point of view. But, if you wrote to him, he would always consider your point of view as well and tell you what he thought.

Bob was greatly saddened by the death of Jim Williams. As you may know, Jim died recently after a massive stroke. During the following days, Bob corresponded with me about Jim. In one e-mail, which I think says a lot about the way Bob thought and lived, he said: "Jim did write more huge SYMPHONIES of big Apps. Systems. I wrote more small ones. We always had very similar ideas on helping Users with Analog problems: We never turned down a request for Analog help. We agreed on that." Then, Bob said: "I am very SCRUPULOUS about taking my 5 or 7.5 mg of Coumadin every day. I don't know if Jim was on Coumadin. Coumadin = Warfarin = Rat Poison, good for preventing Strokes."

Bob also asked me to reprint part of a column on doctoring that he had written years ago about how to tell if someone was having a stroke. This particular column, "What's All This Floobydust, Anyhow? (Part 14)," contains a section called DOCTORING STUFF, PART 4C—STROKE DIAGNOSIS.

In Bob's grief about Jim, his first thought was to let the readers of this magazine know how to tell if someone is having a stroke. He starts off the section of this column by writing: "Many people know that in case of a heart attack or stroke, it is very important to get the victim to medical care very quickly, within much less than an hour. But what do we know about diagnosing such an unhappy person?" And he goes on from there to impart his knowledge on this topic and hopefully help someone save a life someday.

Unfortunately, we now have to say goodbye to Bob and all the wisdom he so generously shared over so many years writing for *Electronic Design*. He was a tremendous talent and we will miss him greatly. You can find his latest column in our July 7 issue.

You won't be surprised to learn that he had the drafts for number of future columns in the works in addition to his popular "Bob's Mailbox" collection of correspondence. We will work with his family on bringing those columns to you in the future. We think he would have wanted you to read them. And finally, wherever he may be right now, I'm sure he's thinking about writing, "What's All This Car Crash Stuff, Anyhow?"



Remembering Bob Pease The Writer



June 20, 2011 01:14 PM
Electronic Design
Don Tuite

I will let other people tell you about Bob Pease the analog designer. He was one of the legends of Silicon Valley. But I knew him more as Bob Pease the compulsive writer. He started his column for *Electronic Design* more than 20 years ago, and even when he was out of the country, trekking in the Himalayas, more often than not, all by himself, or accompanied by a Sherpa guide, his columns appeared in every issue. They were, hands-down the most popular feature in the book.

The column's subject matter was eclectic. Bob could talk about his diabetes as easily as he could talk about current sources or ancient vacuum-tube operational amplifiers. He was strongly opinionated, but he could communicate with a wry sense of humor that endeared him to readers whether they agreed with him or not.

People, especially people involved in technology, wanted to get to know him better. For example, one day, back before I began working for the magazine, my wife came home from work to tell me that she was sure she had bumped into Bob at a filling station. She was as thrilled as if she had met a movie star. (Later, she would get to give Bob a test ride in the Tesla Roadster while I shot the video of the event for Engineering TV.

Bob had that kind of star quality that few people have. I think that's what made his columns so popular. He projected enthusiasm. When you read a Pease column, you could tell that this was a guy who was passionate about whatever had tickled his fancy this time and who wanted to transfer that passion to every one of his readers.

Last Saturday, Bob went to a memorial service for another legendary analog designer, Jim Williams, who had died the previous weekend. It was held at a place called the Mountain Winery, an outdoor concert venue with a restaurant and tasting rooms high on the ridge that forms the backbone of the San Francisco Peninsula. You reach it by the way of a narrow, twisty road that runs off another narrow, twisty road in the forested hills above the tony town of Saratoga.

Those roads were Bob's undoing. On Sunday morning, the Mercury News carried a short item that said a 70-year-old man driving a 1969 Volkswagen had died when he missed a sharp left turn and ran into a tree. The Highway Patrol had not identified the victim to the reporter. At about the same time, I received an e-mail from my friend, and Bob's friend, Paul Rako, who covers the same beat I do for *Electronic Design's* competitor, *EDN*, telling me that the man was Bob.

There is some irony there. I said that Bob was a compulsive writer. Perhaps I should have said obsessive. The irony arises because, besides the columns, Bob wrote and self-published a 470-page book called *How to Drive Into Accidents, and How Not To*, which I'm looking at now. It's like a very, very long version of one of his columns. It contains everything he could think of about automobile accidents, including a section about "Driving On Curvy Roads," along with a list of every traffic accident ever had, along with what he had learned from each.

I don't know what conclusions to draw from that. Life and death don't arrange themselves into tidy patterns the way they do in fiction. But the coincidence is the kind of thing that Bob would have latched onto in one of his columns. It helps fill in the picture, even if it does not offer resolution.

You can't take Bob Pease and fit him into a single category. He was a pioneer in analog IC design. He was literally and figuratively peripatetic. He was intense. He was opinionated. His brain never stopped making connections. And he wanted to teach the world about everything.



An English Major Remembers An Analog Giant



June 21, 2011 06:37 AM
Electronic Design
Richard Gawel

It was late 1998, and I had just joined the *Electronic Design* staff as a copy editor. We were having our weekly editorial production meeting, going around the table and bringing up different concerns. After just a few weeks on the job, I had noticed a pattern and thought to bring it to management's attention.

"This issue's Bob Pease column uses the headline, 'What's All This Manic Stuff, Anyhow?'" I said.

The other editors around the table nodded.

"Before that, he had 'Recipe Engineering Stuff' and 'Circuits In Your Car Stuff.'"

More nodding.

"And next issue, it's 'Prediction Stuff.'"

My manager politely asked me to get to the point.

"Isn't that repetitive? Once or even twice may be funny, but every issue? Isn't the joke old by now?"

The veteran editors, all of whom had worked with Bob before, simply laughed.

"You could try to change it," one of them said. "But I don't think he'll like it."

I didn't know that Bob's headlines were a tradition dating back about a decade and would continue well into today. I've had the privilege, the pleasure, and the education of copy editing nearly all of his columns since then, and it's been a wild ride. It took some getting used to, and we've had our share of disagreements along the way. But readers have always been enthusiastic whenever a new column hits their mailbox or computer screen.

An Unusual Workflow

Bob wasn't a typical contributor. He didn't use Microsoft Word or any kind of desktop publishing system. Instead, he would write his columns directly into the body of his e-mail and send them in. And while most writers go by word count to judge the length of their work, Bob would use byte size.

"Here's the first draft of my next column," he'd typically write. "It's about 3767 bytes. Could you tell me if it's too long?"

Sadly, Word doesn't have a byte-to-word conversion formula. It could be too long, too short, or just right. But I would have no idea until I copied and pasted it into the template that we use to make his column each issue, where I could more accurately eyeball things.

Sometimes we'd need some cuts or fills, but generally we were close to the mark. It was unconventional. And no matter how many times I would suggest it, he never used Word for composing his columns (something about refusing to give Bill Gates even more money). Somehow, it worked. It must have been that engineering insight.

That insight propelled him to come up with an alternative solution for determining column length. Last year, he tried printing his columns out and putting the paper on a scale. He kept track of how much they weighed, thinking more words would equal more ink and therefore more weight, but he didn't find a precise enough correlation to use it as a consistent judge of how long his columns turned out to be.

And that was just the beginning of the process. Bob had a colorful way with words, and smoothing his columns out to match general grammatical style while preserving his unique voice was always a challenge. Bob was fond of using capital letters, italics, punctuation, and irregular spacing for emphasis, employing them the way an artist would use the different colors on his palette.

Even if they weren't always *grammatically* correct, such choices always *felt* right to Bob. For example, last year he accidentally typed "Beast regrds" instead of "Best regards" at the end of an e-mail to a reader. He liked the way it looked,

though, so he decided to incorporate it into his closing in each column. Like all that “stuff” in the headline, it stuck, and we’ve been using it ever since.

We had a running debate on these matters of style versus form. He would say that these choices are part of his style and why readers responded so strongly to his columns. I would say that readers were responding to his ideas, not to his choice of an em-dash over a comma. Or, he would want to capitalize a word like “BIG” to make it clear that he meant something really big. I would suggest a synonym like huge or gigantic if “big” wasn’t, well, big enough a word.

We had a lively give and take on many of these issues, and we’d both have to swallow our pride and make some compromises. Is it the end of the world if we use the word “exactly” three times in the same paragraph? I guess not. And sometimes, he would admit a word like “boring” gets the job done without being in bold print. Of course, revisions were plentiful, mistakes would make their way into the column, and I’m happy to take the blame for them.

Reader Correspondence

Bob loved hearing from readers. He enjoyed answering tricky technical questions, sharing a memory of a long-ago place or part, or simply picking a fight with someone who disagreed with him. “Bob’s Mailbox” has always been one of our most popular features, and it probably was his favorite part of writing for *Electronic Design*. Fortunately for me, but perhaps not for our e-mail server, I was cc’d on every single e-mail between him and his readers. Every. Single. One.

Assembling these Mailbox items could be a chore, too. Bob wouldn’t read a reader’s e-mail and then respond in full. He would insert his replies to individual points the reader would make within the copied body of the reader’s e-mail. This works well in the actual exchange, but reproducing it for print or online was a typographical nightmare. On more than one occasion, one of his comments would be attributed to the reader, or vice versa, and Bob’s sharp eyes would always catch the error.

Bob never pulled his punches either. There were times when exchanges would escalate. Discussion would get heated. Competence would be questioned (and, in a couple of rare instances, so would parentage). Capital letters and exclamation points would be deployed in a shock and awe strategy until, sooner or later, the reader would simply agree to disagree.

Bob rarely admitted defeat. In fact, as recently as this year, he was celebrating his own victory over the proponents of Fuzzy Logic, a debate he said he settled back in the 1990s. That’s no surprise, as Bob’s memory when it came to his own columns was astounding. He could cite points that he made last year, five years ago, or even 20 years ago. Of course, he would say. It’s all clear if you remember his column on amplifiers from 1997, isn’t it?

The Storyteller

I frequently had to scratch my head when Bob would submit his columns. Sometimes I would expect a treatise on getting a better signal out of an analog-to-digital converter, and instead I’d get something on organizational systems for your refrigerator. As an armchair history buff, I always enjoyed his forays into World War II. And then there were the countless hiking stories.

Bob had been around the globe, climbing titanic peaks and exploring deep wilderness. They were impressive tales of physically demanding treks in some of the world’s most exotic locations. While I’ve always enjoyed hiking myself, my adventures have been limited to some of the finer county and state parks in New Jersey, which can be nice in the fall but don’t compare to the glaciers of Nepal.

That dichotomy is part of what made Bob so appealing. He could direct his attention with laser-like focus on anything that interested him, from the cerebral science behind analog engineering to the visceral thrill of ascending to Everest’s Base Camp. One time, when we met for lunch, he used the video camera he happened to have to film his French onion soup since it was particularly cheesy and good.

That was Bob. He knew how to find delight in the moment, whatever it was. He recognized that each experience has something to give us, whether it’s the pure joy it offers, insight into a problem that needs to be solved, or a nugget of wisdom that could be shared with his family, his friends, and his fans. Godspeed, Bob. We will miss you. And best regards.



Our Readers Pay Tribute To A Beloved Columnist



June 24, 2011 05:30 AM
Electronic Design
Staff

We want to thank our readers for the incredible amount of heartfelt and touching condolences and memories you have shared with us this week, in regards to the sudden loss of our friend and colleague, Bob Pease. Twitter and Facebook have also been ablaze with users expressing their shock and sadness, and posting anecdotes about Bob and his work. Many have pointed out the sad coincidence of two of the analog industry's legends passing away within such a short time frame, referring to the very recent death of analog design great Jim Williams.

As we continue to mourn Bob and pay tribute to his contribution to our magazine and our industry on electronicdesign.com, we would like to share some of the sentiments from readers, as posted on our site and Facebook page.

“Such a sad loss of a good person and an outstanding analog engineer. With all his knowledge and worldly wisdom, he was still a down-to-earth man. I had the privilege of exchanging some emails with Bob a month back, regarding an analog circuit someone published in *EDN*. He was very sharp, quick to point out the mistakes I made in analyzing the circuit, while at the same time offering corrections and further help. He was quick in scribbling a circuit, scan it and email it back right away. Other than reading his columns, I did not know him nor did he know me. But I will always appreciate his offer of unconditional help if I needed something in the analog circuits. He was sincerely interested in increasing knowledge and expertise of analog design in engineers and ready to invest his valuable time to do it. People like Bob are hard to come by. He left a big vacuum that is hard to fill. May Bob rest in peace.”

Anoop Hegde on electronicdesign.com

“I knew both Jim Williams and Bob Pease. Personally signed copies of both their books on analog design. Bob showed up at my office one evening, scared the heck out of my wife, yelling "is Bob Landman here?" (he was wearing his backpack and with that beard of his...). He brought the books to me on his way home to SF. Spent time with me, getting to know me, what I was doing. He wrote in his book the following: "Best wishes to Bob Landman - may all your troubles be middlesized: so you can find 'em!" RAP 18xii91... I just can't believe it - "RAP" is dead! I just re-read a hand penned letter to me (he preferred his scrawl to e-mail) on traveling to India. I knew he was the sage trekker to contact for advice on what to bring, what to see, etc.. ...Whenever I needed help... Bob provided it, and with his unique sense of humor. The industry won't be the same without these unique characters. My condolences to both the Williams and Pease families. I'm hearing from many of my friends who are grieving as I am.”

Bob Landman on electronicdesign.com

“Always read his incredible column. Met him at a seminar in Orlando, Fl. a few years back. Corresponded with him via email ... he always answered. I consider him a true servant of engineers around the world! RIP, RAP!”

Ken Whiteleather on electronicdesign.com

“Dang, I had a couple of questions I was meaning to ask Bob. Bob and I had a very interesting e-mail exchange on PID loops (I like the chemical industry version). He will very much be missed.”

M. Simon on electronicdesign.com

“I was shocked to learn that we've just lost two of our iconic spokesmen for the deep nuances of analog circuit design. Both were eloquent with words to describe their thought process for successful circuit design. I regret not having communicated with either after having had the opportunity for more than forty years as I learned from their articles.”

Don Lipke on electronicdesign.com

“This is a truly monumental loss to the engineering profession in general. Bob's observations of the world and the way it works were extraordinary. I always turned to his column before reading anything else in the magazine because I felt that here was this wonderful mixture of compassion, insight and plain old common sense. Although I never met him, my life will be emptier with his passing “.

Peter Ryan on electronicdesign.com

“Truly sad, but we are left better for the great contributions from both men. I only recently began following some of Bob's writings. Bringing clarity to some of the arcanity of design was his great gift and always appreciated his personal insights and observations.”

Michael Violette on electronicdesign.com

"I met up with Bob's writing as a Failure Analyst when I came across "Troubleshooting Analog Circuits". I have followed him through his books and articles ever since. I learned a lot, both about technical and non-technical subjects. And having been diagnosed with Type II Diabetes 5 years ago, I was blessed by his article on his own diagnosis. For someone I never had the pleasure to meet in person, I will miss him an awful lot."

John Melillo on electronicdesign.com

"What sad news! I was working with Bob on a current project and was waiting for a reply. I suspect, from the description, that Bob may have had something go wrong with him before his accident. He had seemed a bit 'tired' to me lately. I will miss our e-mails, inside jokes, analog work and tech talks about vacuum tubes. Our condolences to his family from mine. I remember my first encounter with Bob back in the '70s, when I was a young engineer, in Denver at one of his seminars. His columns were always the first thing I read."

Edwin Pettis on electronicdesign.com

"I was shocked to read of Bob's untimely death. He was truly an inspiration to everyone of his readers. My condolences to his family. May God's peace fill the void left in you hearts at this time of loss."

Marvin Walker on electronicdesign.com

"Unbelievable loss to the design world. True out-of-the-box thinkers and problem solvers. Bob's tutorials, comments and editorials will be surely missed."

Farrell Segall on electronicdesign.com

"I was writing an obituary on Jim Williams and I was already in a sad mode. I needed some facts on the cooperation between Jim and Bob and googled Bob. I did not understand what I read. Bob also gone? It was difficult to grasp the death of Jim. Now, I don't think I will try to understand that Bob also is gone. They were Philbrick, Analog Devices, National's and Linear's missionaries and souls. They were both original, sharp, entertaining and very very good. Miss both of them a lot."

Gunnar Englund on electronicdesign.com

"Rest In Peace, Bob. You will be sorely missed. I followed your column for years and there never was a boring column. A true renaissance person. My condolences to his family. The world has lost an intelligent man."

Dilip Shah on [facebook.com/electronicdesign](https://www.facebook.com/electronicdesign)

"Bob and I exchanged some really nice emails over the years. He was one of my inspirations to begin writing "Balanced Lines"- my monthly tech column for the Delaware Valley Radio Association newsletter. Farewell, Bob. And thank you for the friendship!"

Robert Schroeder on [facebook.com/electronicdesign](https://www.facebook.com/electronicdesign)

"I met Bob back in 1974-5 when my Tate System SQ decoder chips were being implemented. (While my boss was out of the room at our first meeting with National Semiconductor Corp., I was offered a job by their president, Charles Sporck!) But around late October they started work on the chip set development, and I worked with Tim Isbell and others, and met Bob Pease who even then was highly regarded inside NSC. We've corresponded occasionally since. He was a great engineer, and I was shaken by his tragic passing."

Martin Willcocks on [facebook.com/electronicdesign](https://www.facebook.com/electronicdesign)

"We will miss Bob's great wit and wisdom. He is now in the great analog heaven in the sky!"

Mike Nolen on [facebook.com/electronicdesign](https://www.facebook.com/electronicdesign)

"... I corresponded with Bob Pease and was always given a reply even if he felt my concerns were overblown. However, my contention that he was driving a death trap has proved to be true. I urged him to junk that 1969 and get a newer safer model, he could well afford it. But in his usual 'basics only style' he stayed true to it. I will miss our friend."

Frank Skocilich on electronicdesign.com

"Bob Pease and Jim Williams were both great Mentors in the field of electronics, and both will be missed and remembered by all the engineers including myself that had the privilege of meeting them and benefiting from their insights and wisdom. Their writings shall be a valued gift for all of us now and for future generations of engineers. My sincere condolences to the Pease and Williams Families."

James Williams on electronicdesign.com

"My wife and I were both shocked and very sad to hear of Bob's passing. Bob and I were friends while we both worked at Teledyne Philbrick in Dedham, MA, but as of late the only way I followed him was in his articles in Electronic Design. As a matter of fact I had his latest article folded back to re-read and 'Pease Porridge' was my main reason for keeping my subscription current after I retired. I could relate many stories of our times back at T/P with Bob and the famous annual Camel Awards he was so proud of. Many times I would walk into his office and he would have one of his three dimensional circuits hanging with clip leads from a ceiling tile. I could never figure it out but of course Bob knew what he was doing. Bob was very brilliant, but always willing to talk to you, and will be sorely missed by all. Our deepest condolences to his wife and family. "

Martin Liben on [facebook.com/electronicdesign](https://www.facebook.com/electronicdesign)

"We have lost one of the last few "great ones" of this profession. I had the privilege of talking to Bob recently when I called him with a really strange problem we were experiencing (suffice to say that we never met before). He helped us selfishly and completely. He was that kind of guy... My colleagues and I will surely miss his "Pease Porridge" insights. He will be greatly remembered and deeply missed. Godspeed Bob!"

Jorge Sanguinetti on [facebook.com/electronicdesign](https://www.facebook.com/electronicdesign)

"A shame to see such a great man pass away. Bob was there to help and even pioneer. RIP RAP"

Derek Koonce on [facebook.com/electronicdesign](https://www.facebook.com/electronicdesign)

What's All This Solo Hiking Stuff, Anyhow? (Part 2)



July 12, 2011 01:52 PM 8/11/2011
Electronic Design
Bob Pease

[Editor's Note: While Bob Pease passed away on June 18, he was working on the drafts of several additional columns before he died. We will continue to share his work with you, since there's always one more story.]

There are some places I really don't want to hike solo. I like to minimize it in the winter, or in treacherous territory, or in a cave. Yet there are some places where you have to hike solo.

If you're hiking in a duo, and one person gets hurt, the other person will usually go for help. But what if it's nearly dark, and the good hiker has no confidence he can get help? He might stay and help light a fire, etc., and go in the morning.

If you're hiking in a group of three, and someone gets hurt or disabled, one person can stay with the hurt person, and the third person will usually go for help, subject to the limitations above. I usually like the feeling of hiking solo, though, except in the cases noted above. I may not like it, but I can do it.

I have hiked in duos in the winter, with my wife or another friend. It's a risk I'll consider, even three or four miles from roads. I prefer hiking in a duo when the countryside is really rough and obscure. The walking is challenging enough, so even sharing the concerns with another person, it can be risky!

Wild Welsh Weather

One time I was hiking with Nancy with HF Holidays in Wales, about 2004. She went on an easy hike and I took the tougher hike, up Carnedd Davydd (dd is pronounced th in Welsh), about 10 miles east of Snowdon. It was off the A5, southwest of Conwy Wales by about 17 miles. It was going to be an easy ridge-top loop.

The first mile was easy on a lane, and then up to a quarry. A bit of clambering, steep, and then up onto a ridge. The wind picked up. A lot. Soon, we were staggering in the high wind. I had a hiking stick, and it was still shaky. The women, being lighter, were in a worse problem, and we held their hands. The wind got worse. The clouds were whipping past.

It was well above 50 or 60 mph. It could have been up to 70 or 80 or more. There was no way to judge. We finally found a small "corrie" where a sheep-herder had gathered a small ring of stones for him and his sheep to be protected from just such blows. We hunkered down.

After a half hour, the wind was not abating. We ate a snack. How could we get out? We didn't like the way we'd come up. Could we bail over the edge to the north? We checked the map and ran some small experiments—yeah, we could.

We held hands and eased down. The winds were still high. After we got down 100 feet, the wind was slacking off. Lower, the wind became minor. We hiked down to the road, and the leader went to get our van. What a heck of a windy day! Nancy said the "easier" hike by the sea was very windy, too.

Seeing More Of Wales Solo

Eight days later, I went back up there, solo. I started up the same trail, and it went fine but there was no wind! It was warm and very cloudy/foggy, and as I came up by the corrie, the wind picked up to 1 mph. Since I was moving about 1 mph, I got quite warm, and my shirt was utterly, completely soaked from the sweat and the fog. But I could live with that.

Up on the ridge, I met a good bloke who knew the area and gave me some advice, and we walked a ways up to the top of the ridge, to the first hill, Carnedd Davydd, and then to the second, Carnedd Lewellyn. He continued south.

I wanted to walk east to a nearby third (unnamed) hill I had been hiking on, the other day, barely a half mile over. These trails and hills were not signed. But I had my GPS with me and it was working well, so I marked a waypoint there on the GPS. The view was perfectly socked in. Couldn't see 80 feet.

I walked off to the east, down a shallow slant, where the trail was not well indicated. Hell, the trail petered out! I walked in the heavy mist and fog. It was a shallow saddle, not like a horse's neck, but like an elephant's broad back. I got to the third hill and then over to the stone hut where I had rested a week before. So I really did know exactly where I was. Then after a snack and a short rest, I started back.

When I came up to the third hill, I had made good mental notes on the lay of the land, and the lines of stones, so I thought I could find my way back to the second hill without any wear or tear on the GPS. I started back and soon got suspicious that I was not going the right way.

I turned on my GPS, which indicated that I was going off on a side angle, badly. The longer I walked, the crazier the angle to that waypoint became. I think that third hill went off onto four or five different shallow saddles. Would I trust the GPS?

I damn well did trust the GPS, and I went off in the direction it recommended, and the angle back to the second hill stayed steady. (My GPS does not show a compass setting, but if I am moving in a direction, it will indicate what that direction is.)

Every time I walked 100 feet in the right direction, the distance to the waypoint at the second hill decreased by "0.02 mile." I finally snuck up on that second hill, and after a short rest, headed south, down and out. I came down out of the cloud and eventually got back to my car. Good tough day! Time to take my soaked shirt home to my cottage near Conwy.

If I'd gotten lost up there, or stuck in that hut, nobody knew where I was. If the wind had come up, or significant rain, while I was not on course, I had enough clothes to keep me warm, just barely. But nobody was going to come looking for me for a day or two. So I really had to be careful. That's the consideration when hiking solo.



Bob's Mailbox: More Mail About Unintended Acceleration



August 10, 2011 10:26 AM 9/8/2011
Electronic Design
Bob Pease

Bob,

I remember riding with my dad in our 1963 Chevrolet wagon. I believe it was a Bel Air. The accelerator suddenly went to the floor, with no desire to come back up. Dad did just what you suggest, and turned the car off. Of course, in those days, power steering and power brakes were really options, and I don't remember if our car had them. It probably didn't have the locking steering column. We pulled over and opened the hood. The throttle mechanism had a good sized spring that applied the return pressure. That spring had come loose. [Check. Of course. /rap]

We fortunately found it sitting in the engine compartment and were able to replace it. Dad finished our errand driving rather gingerly, and then we got a new spring and made the mounting more secure. [Tie the spring to its connections with fine copper wire. /rap] I wonder how common that condition was back then.
- Earl Erickson

Probably pretty common. Thanks for the comments. Beast rgrds. /rap

Hello Bob,

Some years ago, around 1992-1993 I think, I was driving a rental vehicle to work because my own was in the shop. I believe it was one of the early Isuzu Troopers that still looked like they had been partially run through a car crusher applied from the side. Technically, I suppose you would call it a poor wheel base to height ratio.

Anyway, I had driven this thing on the freeway for maybe 15 minutes and tied up nearly to a standstill in traffic when I felt the accelerator pedal moving away from my foot. I instinctively stepped on the brakes and started generating a smokescreen you wouldn't believe and attracting lots of gawkers. Shortly thereafter (very shortly), I put it in neutral, shut off the key, and glided to the side of the freeway. [Good man! /rap]

I sat there for about 20 minutes recovering from the shock and trying to figure what to do. I had even at that time heard a few stories of unintended acceleration, and being slightly familiar with thermal runaway effects in electronic devices, I acted on a hunch [Good hunch. /rap] and tried an experiment to see if this might be what was going on.

So, I let the engine cool off for a while and then restarted it and started slowly driving down the freeway. It was initially okay, but after a few more minutes, it started to show the same behavior. This time I was ready and pulled over to the side and shut off the engine.

After another 10 minutes, I started up again and got several more miles under my belt before it acted up again. It was becoming predictable so I repeated this process probably half a dozen times more before I finally pulled into the parking lot at work. [And what made you suspect something was wrong? /rap]

I immediately called the rental company to bring me another vehicle and explained what I was experiencing. The young man thought I was either crazy or drunk, but eventually agreed to bring the other vehicle. [Good man. /rap]

I naturally cautioned him about the nature of the problem, how to watch for it and what to do when it started manifesting. I think he still thought I was crazy but went on his merry way. I never heard back from them about it. So, that's how I became a believer in unintended acceleration! [Wise fellow. /rap] It never happened to me again, though.
- Paul Jones

Yeah, because you never drove that ratty Isuzu again. Thanks for writing. Beast rgrds. /rap

Robert,

Back in the early days before cruise control (early 1960s), I purchased kits and installed them on my cars and always was careful when connecting up the vacuum operated actuator to the throttle linkage. I never had a problem but was so glad that the option became available so I could spend more time on other similar and somewhat questionable projects I think of as hobbies.
- Bob E. Morley

I designed an inside-my-head Cruise Control (see "What's All This Cruise Control Stuff, Anyhow?" at www.electronicdesign.com). It worked as I planned it—and I still didn't like it. It boxed me at a constant speed, into traps in traffic, where I'd have to slow down and maneuver around slow traffic. I'm better off controlling my own speed and avoiding traps.

Out on I-280, cops don't care if you are going 60, 65, 70, 75, or 85. (I'm not sure about 90.) I don't go over 80 unless there is a serious problem or disaster. So, I don't need a cruise control to keep me from getting a ticket. (That may not be true everywhere...) So if I had a real store-bought cruise control, it wouldn't do what I want.

Beast rgrds. /rap

Bob's Mailbox: Audio Quality, A Crazy Rack, And The PE Exam

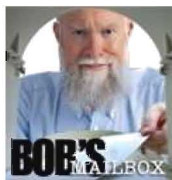

October 21, 2011 11:42 AM 11/10/2011

Electronic Design

Bob Pease

Bob,

I just handmade a headphone amp for a good friend's birthday. I have auditioned it favorably and I am sure she will love it. Topology: one tube gain stage (a 12AX7 clone type), then a MOSFET source follower running at 60 mA quiescent, BJT current source. **[You don't trust the LME49610? /rap]**

The solid-state rail is 28 V tightly regulated. All the input stage coupling caps are 1- μ F, 250-V polyester (MKT dielectric). The Zin is 100k, which means a time constant of ca 70 ms throughout. **[Why? /rap]** The bass response kicks **[butt]** completely, auditioned on my very good cans, as it should. **[So, what if you put in 3- μ F polyester? Really? What harm? /rap]**

My good friend Trevor Lees (we graduated together), who owns the best high-end audio business in town, always says for best audio quality, all of the time constants in any circuit must be the same throughout. **[He seems to have a fairly parochial view. I can't imagine why he'd say that. Having one ruling time constant sounds roughly plausible, but having a couple slower taus can't possibly do any harm. Having dc coupling can't do any harm. So I guess I will have to go to my fallback position, "Avoid getting into arguments with [jerks]."/> /rap]**

What I do notice is that this style of open-loop topology does sound marginally better than a cruddy feedback-linearized circuit. **[You seem to think that sounds different and better. But maybe a good engineer could study the "cruddy feedback" circuit and find something wrong with it. You could carry that schematic with you when you come to the States, and I'd love to look at it. If there is any reason why feedback sounds different or worse, I would love to find it and understand why. /rap]**

The part needing the most attention is appropriate shielded wiring and star earthing and a metal box since the 100k Zin even responds to passing your hand over the top of it. **[That part I believe. But does it even do that when you ground yourself? Does that not apply to other circuits? Think about it. Come on. Be reasonable. /rap]**

Watch out for the fancy "audio quality" cap scam, Bob. They are mostly just rebrands of cheap commercial film caps. The extreme nuts will lay down gold bars for special very fancy "oil and silver foil" caps that must somehow help them to sleep better or somehow convince them they are much better than their next-door neighbor. Funny ol' world, innit Bob? Beastliness prevails! "JCD"

I've heard of that! /rap

Bob:

Just had to write (my first time to you) after reading your latest column, "Bob's Mailbox: PLL Circuits, Hiking Experiences, And More Reader Reactions" (available at www.electronicdesign.com) as the subjects and comments speak to a story from my past. I also ran into some superb engineers who were not fully educated as such. **[Yeah, I know some guys like that. /rap]**

Take the most brilliant designer I ever know. I used to work in the main R&D labs of a huge telecom manufacturer, once (briefly) the largest in the world and now defunct, name starting with N, headquartered in a country not very far directly north of you. The fellow in question was a student intern midway through his third year, stayed on, and never went back to school. **[The University of Hard Knocks can be a really good teacher. /rap]**

Several years later, the core processor group was designing with the then new Motorola 68030. One manager was worried about a tight specification on the master clock duty cycle and told the young engineer to go away and solve it. Said engineer then disappeared for six months and returned with an entire rack of equipment involving multiple nested PLLs (phase-locked loops), which could control the duty cycle of this clock to within a fraction of a picosecond. **[And he couldn't show you a simplified version that does what you really needed? Ha! /rap]**

I saw it, and it was impressive, to the point of involving special measurement techniques to prove the sub-picosecond control. Brilliant engineering, yes. Totally impractical, yes. (His efforts were never put onto the processor board, of course.) Had I not known the guy, I would have assumed this was the product of a PhD's thinking.

I also loved your response to the naive young reader from India. I don't think I would qualify for the job he wants, and I have been building circuits since public school, am a radio amateur, have a master's degree (filter design), and have more than 30 years experience in analog, digital, and mixed-signal. But the young need to have goals and ambition, and maybe someday he will make the cut. Best wishes to you. Keep writing. -Wayne Chomik

Thanks for writing! /rap

Bob Pease:

Why haven't you taken the PE exam, which is a hallmark of professional excellence in the U.S.? -Sunil Pedgaonkar

I've been too busy to take the final test. Too busy designing real circuits and helping solve people's real problems. And writing columns to teach people how to stay out of real trouble. Taking a PE exam doesn't help people stay out of trouble. Beast regards. /rap