

Power Topologies Handbook

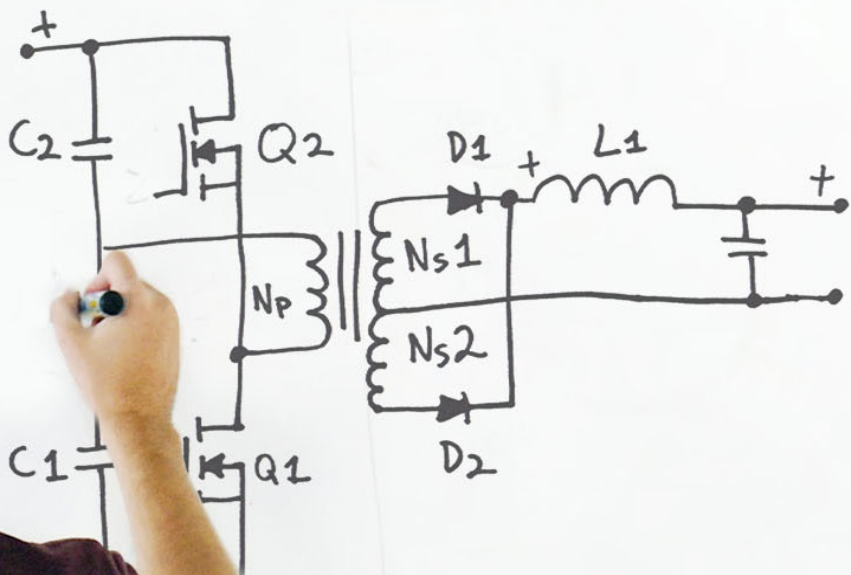

Half - Bridge

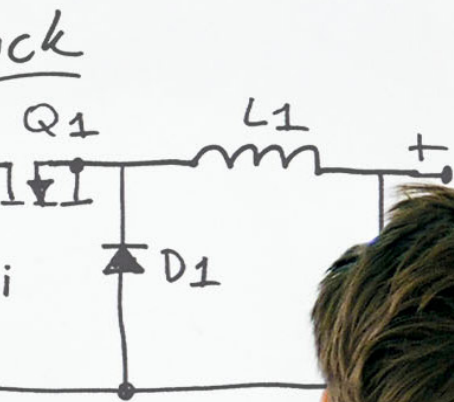

$$= \frac{V_{OUT} + V_F}{V_{IN} + V_F}$$

$$1 = V$$

$$1 =$$

$$\frac{V_{OUT} + V_F}{V_{IN} \times \frac{N_p}{N_s}}$$

$$V_{Q1} = V_{IN}$$

$$N_p = V_F$$

$$N_p = V_F$$

This book shows waveforms and equations of the most common hard switched power supply topologies and the soft switched Phase-Shifted Full-Bridge. All equations are ideal with the only exception, that the forward voltage of rectifier and freewheeling diodes is taken into account. All those equations are also used in Texas Instruments's Power Stage Designer Tool, which can be found on the TI website under:

www.ti.com/tool/powerstage-designer

Power Topologies Handbook

Markus Zehendner, Matthias Ulmann

chapter 1	Abbreviations and General Information	5
chapter 2	General Equations for Calculating RMS and AC Currents	9
chapter 3	Buck Converter	15
chapter 4	Boost Converter	23
chapter 5	Inverting Buck-Boost Converter	31
chapter 6	SEPIC	39
chapter 7	Cuk Converter	49
chapter 8	Zeta Converter	59
chapter 9	Flyback Converter	69
chapter 10	Two Switch Flyback Converter	81
chapter 11	Active Clamp Forward Converter	91
chapter 12	Single Switch Forward Converter	105
chapter 13	Two Switch Forward Converter	119
chapter 14	Push-Pull Converter	131
chapter 15	Weinberg Converter	145
chapter 16	Half-Bridge Converter	157
chapter 17	Full-Bridge Converter	171
chapter 18	Phase-Shifted Full-Bridge Converter	185

Abbreviations and General Information

Expression	Abbreviation
Continuous Conduction Mode	CCM
Discontinuous Conduction Mode	DCM
Alternating Current	AC
Root Mean Square	RMS
Synchronous Rectifier	SR
Right Half Plane Zero	RHPZ
Input Voltage	V_{in}
Output Voltage	V_{out}
Output Current	I_{out}
Diode Forward Voltage	V_f
Switching frequency of the power supply's FET	f_{switch}
Switching period	$T_{switch} = \frac{1}{f_{switch}} = t_1 + t_2 + t_3$
Time, when the FET is conducting and current in the inductor is increasing.	t_1
Time, when the FET is not conducting and current in the inductor is decreasing.	t_2
Time, when the FET is not conducting and constant current or no current flows through the inductor for non-interleaved switching topologies. For interleaved switching topologies (e.g. Push-Pull) the current will decrease to 0A during that time.	t_3
Phase Shift Time	t_{ph}
Demagnetization Time	t_d
Time after demagnetization. Time period between t_d and t_1 in DCM. Only applies for Single Switch Forward and Two Switch Forward.	t_{ad}
Duty Cycle	$D = t_1 \cdot f_{switch}$

About Discontinuous Conduction Mode

A switch mode power supply enters Discontinuous Conduction Mode when half the inductor current ripple exceeds the average inductor current. Respectively the relative inductor current ripple will have a value of 200% or greater in DCM and the current will have a minimum value of 0A during t_3 . An exception is the synchronous Buck converter without diode emulation, where the inductor current can also become negative, because it remains in CCM under conditions a non-synchronous Buck regulator enters DCM. In case of the SEPIC, Cuk and Zeta topologies the before mentioned conditions for DCM are a little bit different as those topologies contain two inductors. The inductor currents both have an offset in relationship to the input and output current. DCM is entered when both offsets have the same absolute value and sum up to zero. The relative inductor current ripple in DCM is also 200% or greater for SEPIC, Cuk and Zeta converters and the current during t_3 will equal the value of the offset.

About Inductors and Transformers

Coupling between coupled inductors and for transformer windings is assumed to be ideal. The equations for SEPIC, Cuk and Zeta converters are for uncoupled inductors: When calculating with coupled inductors for those topologies use double the value of the component's inductance. This also means that for the same ripple requirement a coupled inductor with half the inductance of a single inductor solution is sufficient. Another benefit of using coupled inductors for Cuk, SEPIC and Zeta is that the resonant frequency between inductors and coupling capacitor does not have an effect on the power supply's frequency response, but does with single inductors.

About Diodes

The forward voltage drop of rectifier and freewheeling diodes (D_1 and D_2 , as well as D_3 for the Weinberg) is taken into account for all calculations. It is assumed that the forward voltage drop is identical for those. The forward voltage drop for demagnetization diodes (D_3 and D_4) is neglected for all equations.

About How waveforms are being displayed

The voltage and current waveforms of components are displayed in the direction the current is flowing through them. Exceptions are the secondaries of transformers and coupled inductors, because they are considered to be current sources. This results in the signs of current and voltage being inverse. For Inverting Buck-Boost and Cuk output voltage and current have to be negative values for calculations. The direction of voltage and current waveforms for the synchronous rectifier in the synchronous Buck regulator point to the opposite direction compared to the diode in the non-synchronous Buck regulator, because the voltage is measured from Drain to Source in this special case.

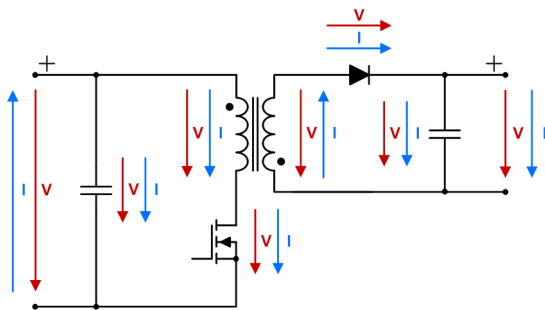

Figure 1.0.1. Example of how the waveforms of a Flyback converter are displayed.

About Right Half Plane Zero

For Boost, Inverting Buck-Boost, Cuk, SEPIC, Flyback and Two Switch Flyback topologies the equations for the right half plane zero are very simplified and thus give the designer only an estimation of the frequency. Please consider that SEPIC and Cuk converters have more than one RHPZ and only one of them can be calculated to a certain extent.

General Equations for Calculating RMS and AC Currents

2.1. Positive triangular waveforms without offset

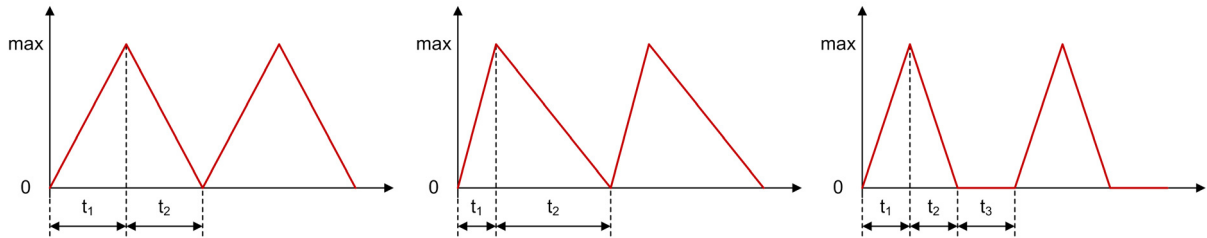

Figure 2.1.1. Positive triangular waveforms without offset

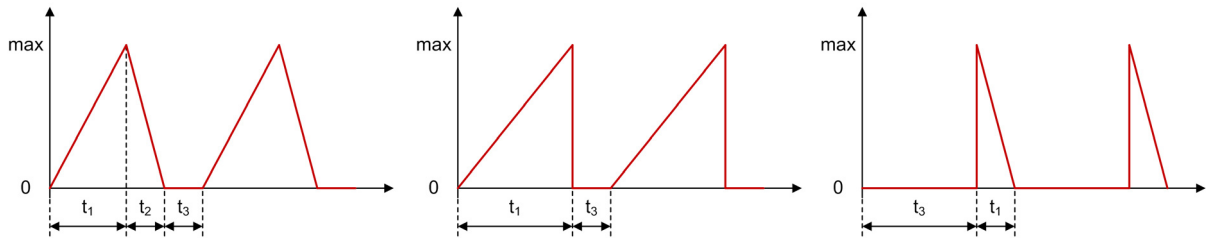

Figure 2.1.2. Positive triangular waveforms without offset

Average:

$$avg = \frac{1}{T_{switch}} \int_0^{T_{switch}} i(t) \cdot dt$$

$$avg = \frac{max}{2} \cdot \frac{t_1+t_2}{T_{switch}}$$

RMS:

$$rms = \sqrt{\frac{1}{T_{switch}} \int_0^{T_{switch}} (i(t))^2 \cdot dt}$$

$$rms = max \cdot \sqrt{\frac{t_1+t_2}{3 \cdot T_{switch}}}$$

AC:

$$ac = \sqrt{rms^2 - avg^2}$$

2.2. Positive triangular waveforms with offset

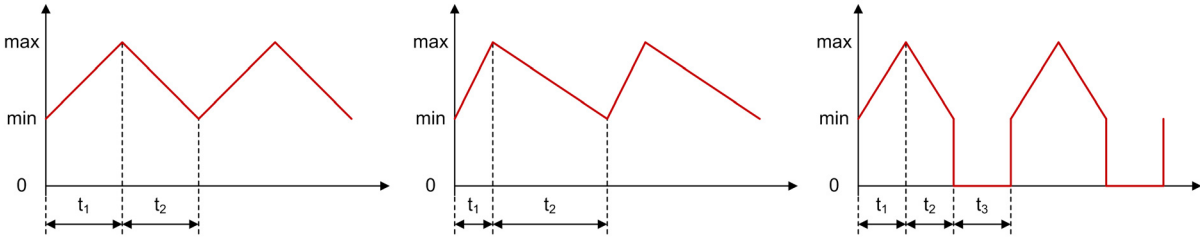

Figure 2.2.1. Positive triangular waveforms with offset

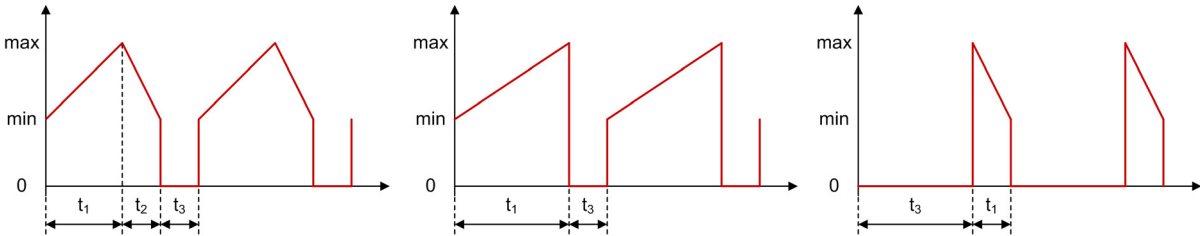

Figure 2.2.2. Positive triangular waveforms with offset

Average:

$$avg = \frac{1}{T_{switch}} \int_0^{T_{switch}} i(t) \cdot dt$$

$$avg = \frac{min+max}{2} \cdot \frac{t_1+t_2}{T_{switch}}$$

RMS:

$$rms = \sqrt{\frac{1}{T_{switch}} \int_0^{T_{switch}} (i(t))^2 \cdot dt}$$

$$rms = \sqrt{\frac{t_1+t_2}{T_{switch}} \cdot \left(min \cdot max + \frac{(max-min)^2}{3} \right)}$$

AC:

$$ac = \sqrt{rms^2 - avg^2}$$

2.3. Positive and negative triangular waveforms without offset

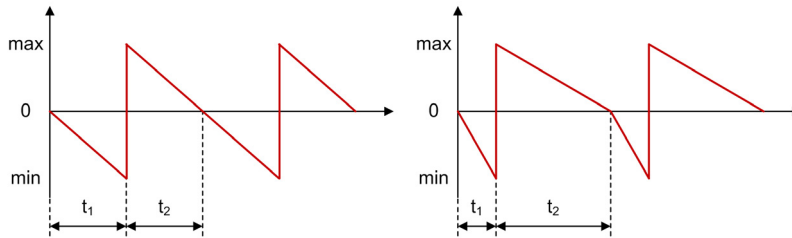

Figure 2.3.1. Positive and negative triangular waveforms without offset

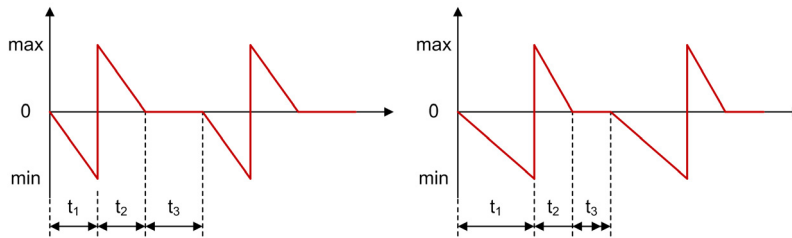

Figure 2.3.2. Positive and negative triangular waveforms without offset

Average:

$$avg = \frac{1}{T_{switch}} \int_0^{T_{switch}} i(t) \cdot dt$$

$$avg = \frac{min}{2} \cdot \frac{t_1}{T_{switch}} + \frac{max}{2} \cdot \frac{t_2}{T_{switch}}$$

RMS:

$$rms = \sqrt{\frac{1}{T_{switch}} \int_0^{T_{switch}} (i(t))^2 \cdot dt}$$

$$rms = \sqrt{\left(min \cdot \sqrt{\frac{t_1}{3 \cdot T_{switch}}} \right)^2 + \left(max \cdot \sqrt{\frac{t_2}{3 \cdot T_{switch}}} \right)^2}$$

AC:

$$ac = \sqrt{rms^2 - avg^2}$$

2.4. Positive and negative triangular waveforms with offset

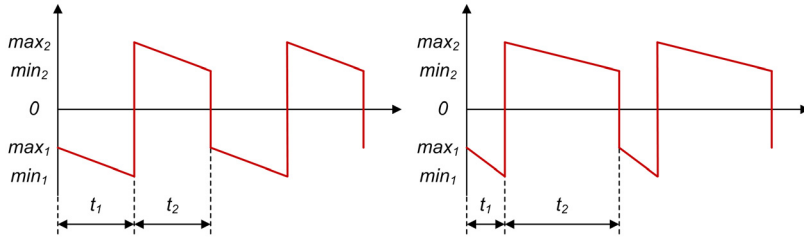

Figure 2.4.1. Positive and negative triangular waveforms with offset

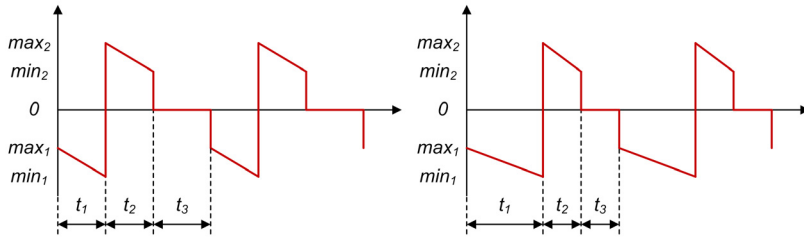

Figure 2.4.2. Positive and negative triangular waveforms with offset

Average:

$$avg = \frac{1}{T_{switch}} \int_0^{T_{switch}} i(t) \cdot dt$$

$$avg = \frac{min_1 + max_1}{2} \cdot \frac{t_1}{T_{switch}} + \frac{min_2 + max_2}{2} \cdot \frac{t_2}{T_{switch}}$$

RMS:

$$rms = \sqrt{\frac{1}{T_{switch}} \int_0^{T_{switch}} (i(t))^2 \cdot dt}$$

$$rms = \sqrt{\frac{t_1}{T_{switch}} \cdot [max_1 \cdot min_1 + \frac{(max_1 - min_1)^2}{3}] + \frac{t_2}{T_{switch}} \cdot [max_2 \cdot min_2 + \frac{(max_2 - min_2)^2}{3}]}$$

AC:

$$ac = \sqrt{rms^2 - avg^2}$$

2.5. Universal equations for positive and negative triangular waveforms with Offset and three time components

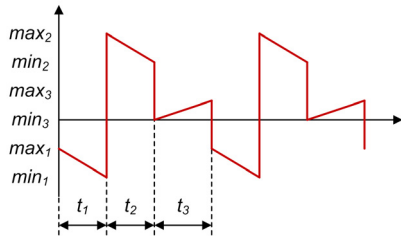

Figure 2.5.1. Positive and negative triangular waveforms with offset

Average:

$$avg = \frac{min_1 + max_1}{2} \cdot \frac{t_1}{T_{switch}} + \frac{min_2 + max_2}{2} \cdot \frac{t_2}{T_{switch}} + \frac{min_3 + max_3}{2} \cdot \frac{t_3}{T_{switch}}$$

RMS:

$$rms = \sqrt{\sum_{n=1}^3 \left[f_{switch} \cdot t_n \cdot \left(max_n \cdot min_n + (max_n - min_n)^2 \right) \right]}$$

AC:

$$ac = \sqrt{rms^2 - avg^2}$$

Buck Converter

A Buck converter steps down an input voltage to a lower output voltage level. The energy is transferred to the output when the FET is conducting.

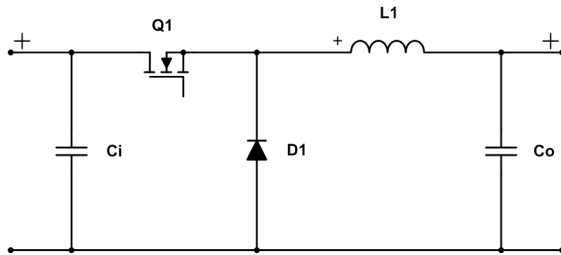

Figure 3.0.1. Schematic of a non-synchronous Buck converter

For calculating a synchronous Buck converter set $V_f = 0V$. The waveforms for the synchronous Buck converter show the operation in a forced PWM scenario, where a non-synchronous Buck converter would enter DCM. For normal operation there is an additional positive DC offset for the current of FET and Inductor. The CCM waveforms can be used as reference. In case of the synchronous rectifier current the additional DC offset is negative.

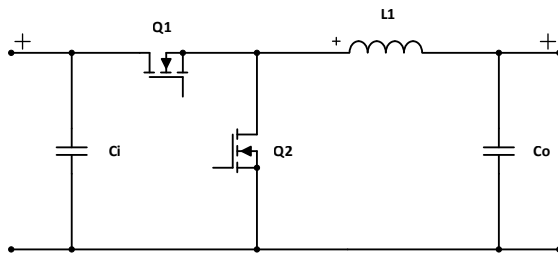

Figure 3.0.2. Schematic of a synchronous Buck converter

3.1. General

Inductor Current Ripple: $I_{ripple} = \frac{1}{L_1} \cdot (V_{in} - V_{out}) \cdot t_1$

3.1.1. Continuous Conduction Mode & Synchronous forced PWM.

FET on, increasing current: $t_1 = \frac{1}{f_{switch}} \cdot \frac{V_{out} + V_f}{V_{in} + V_f}$

FET off, decreasing current: $t_2 = \frac{1}{f_{switch}} - t_1$

Min. Inductor Current: $I_{min} = I_{out} - \frac{I_{ripple}}{2}$

Max. Inductor Current: $I_{max} = I_{out} + \frac{I_{ripple}}{2}$

Average Input Current: $I_{in,avg} = \frac{V_{out} \cdot I_{out}}{V_{in}} + \frac{V_f}{V_{in}} \cdot \frac{I_{min} + I_{max}}{2} \cdot t_2 \cdot f_{switch}$

3.1.2. Discontinuous Conduction Mode.

FET on, increasing current: $t_1 = \sqrt{2 \cdot I_{out} \cdot L_1 \cdot \frac{V_{out} + V_f}{f_{switch} \cdot (V_{in} - V_{out}) \cdot (V_{in} + V_f)}}$

FET off, decreasing current: $t_2 = t_1 \cdot \frac{V_{in} + V_f}{V_{out} + V_f} - t_1$

FET off, no current: $t_3 = \frac{1}{f_{switch}} - t_1 - t_2$

Min. Inductor Current: $I_{min} = 0A$

Max. Inductor Current: $I_{max} = \frac{1}{L_1} \cdot (V_{in} - V_{out}) \cdot t_1$

Average Input Current: $I_{in,avg} = \frac{V_{out} \cdot I_{out}}{V_{in}} + \frac{V_f}{V_{in}} \cdot \frac{I_{min} + I_{max}}{2} \cdot t_2 \cdot f_{switch}$

3.2. Inductor L_1

3.2.1. CCM, DCM & Synchronous forced PWM.

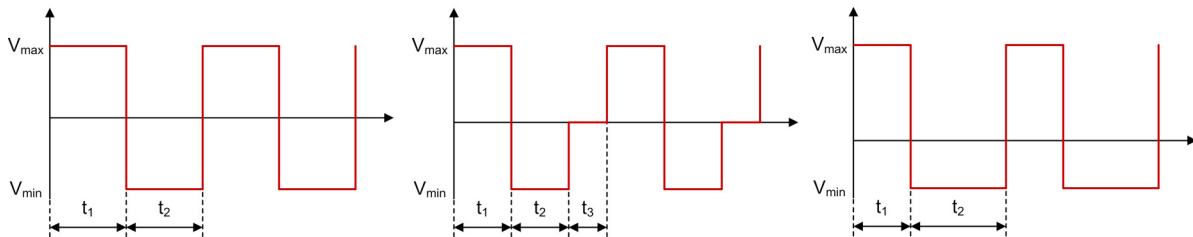

Figure 3.2.1. Buck - Inductor L_1 Voltage Waveforms in CCM, DCM and synchronous forced PWM

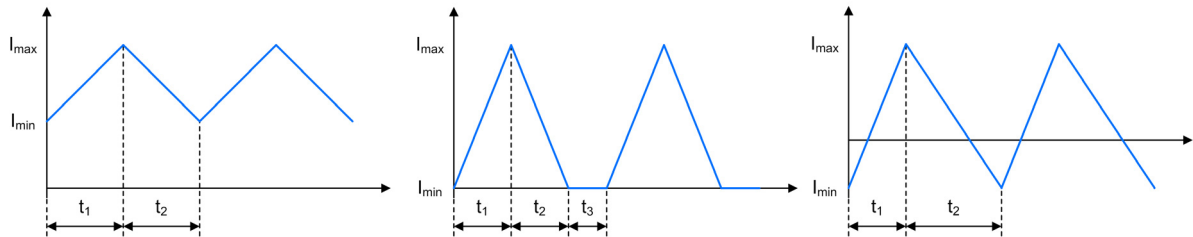

Figure 3.2.2. Buck - Inductor L_1 Current Waveforms in CCM, DCM and synchronous forced PWM

Average Inductor Current: $I_{L1,avg} = \frac{I_{min} + I_{max}}{2} \cdot (t_1 + t_2) \cdot f_{switch}$

Min. Inductor Voltage: $V_{L1,min} = -V_{out} - V_f$

Max. Inductor Voltage: $V_{L1,max} = V_{in} - V_{out}$

Inductor Voltage during t_3 : $V_{L1,t3} = 0V$

3.3. FET Q_1

3.3.1. CCM, DCM & Synchronous forced PWM.

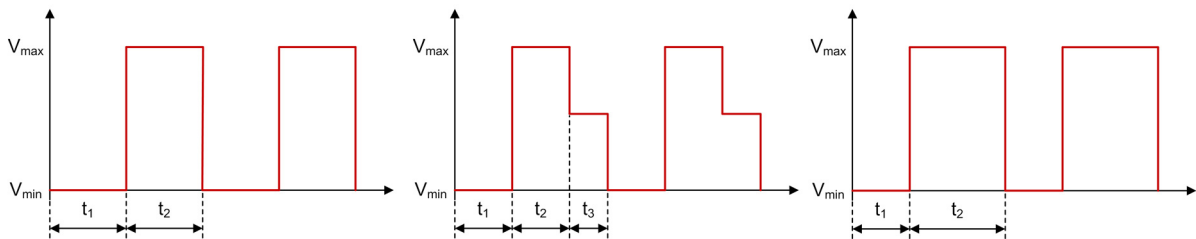

Figure 3.3.1. Buck - FET Q_1 Voltage Waveforms in CCM, DCM and synchronous forced PWM

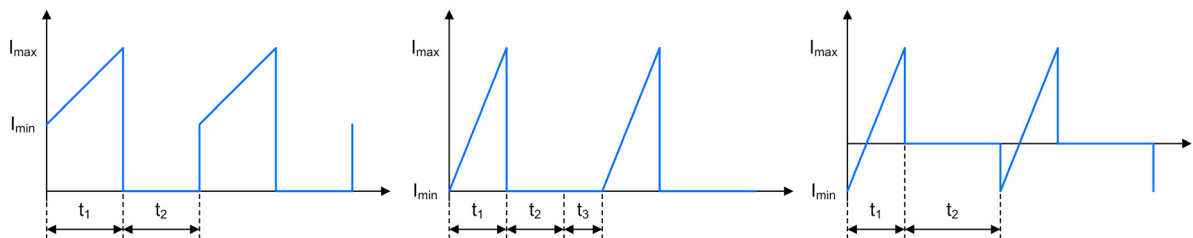

Figure 3.3.2. Buck - FET Q_1 Current Waveforms in CCM, DCM and synchronous forced PWM

Average FET Current:	$I_{Q1,avg} = \frac{I_{min}+I_{max}}{2} \cdot t_1 \cdot f_{switch}$
Min. FET Voltage:	$V_{Q1,min} = 0V$
Max. FET Voltage:	$V_{Q1,max} = V_{in} + V_f$
FET Voltage during t_3 (DCM):	$V_{Q1,t3} = V_{in} - V_{out}$

3.4. Diode D_1

3.4.1. CCM & DCM.

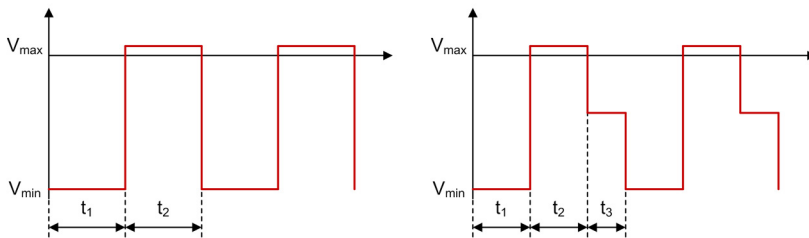

Figure 3.4.1. Buck - Diode D_1 Voltage Waveforms in CCM and DCM

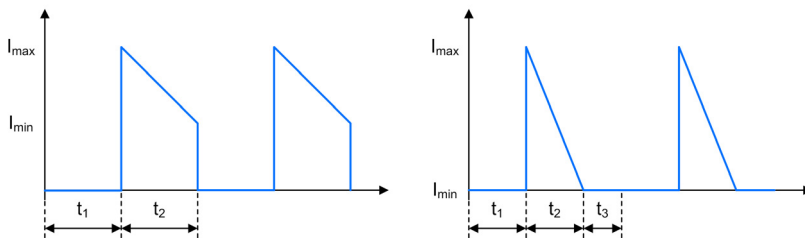

Figure 3.4.2. Buck - Diode D_1 Current Waveforms in CCM and DCM

Average Diode Current:	$I_{D1,avg} = \frac{I_{min}+I_{max}}{2} \cdot t_2 \cdot f_{switch}$
Min. Diode Voltage:	$V_{D1,min} = -V_{in}$
Max. Diode Voltage:	$V_{D1,max} = V_f$
Diode Voltage during t_3 :	$V_{D1,t3} = -V_{out}$

3.4.2. Synchronous Rectifier FET Q_2 - forced PWM.

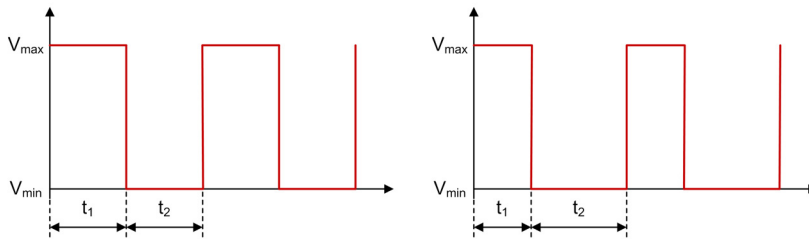

Figure 3.4.3. Synchronous Buck - Synchronous Rectifier FET Q_2 Voltage Waveforms in CCM and forced PWM mode

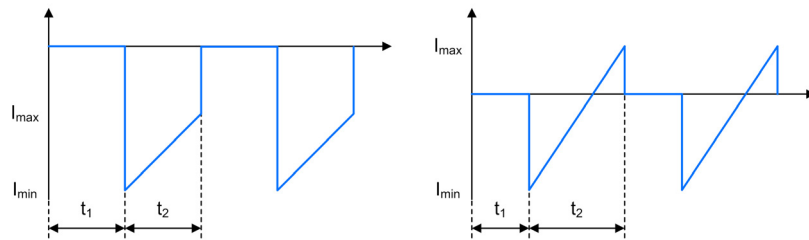

Figure 3.4.4. Synchronous Buck - Synchronous Rectifier FET Q_2 Current Waveforms in CCM and forced PWM mode

Average SR Current: $I_{Q_2,avg} = \frac{I_{min} + I_{max}}{2} \cdot t_2 \cdot f_{switch}$

Min. SR Voltage: $V_{Q_2,min} = 0V$

Max. SR Voltage: $V_{Q_2,max} = V_{in}$

3.5. Input Capacitor C_i

3.5.1. CCM, DCM & Synchronous forced PWM.

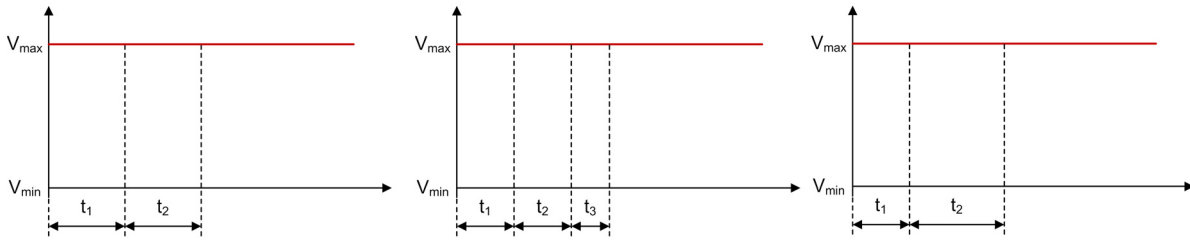

Figure 3.5.1. Buck - Input Capacitor C_i Voltage Waveforms in CCM, DCM and synchronous forced PWM

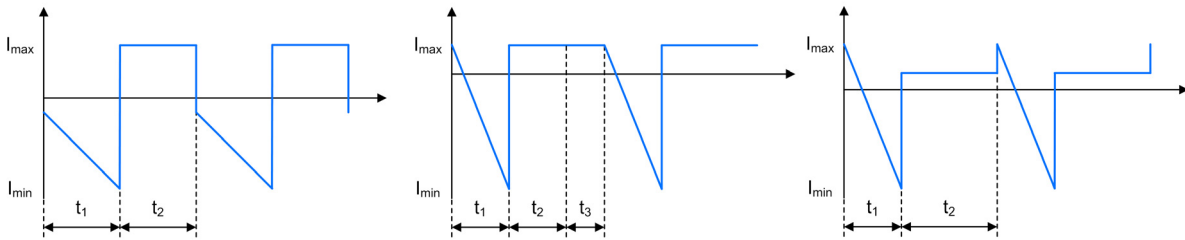

Figure 3.5.2. Buck - Input Capacitor C_i Current Waveforms in CCM, DCM and synchronous forced PWM

Min. Input Capacitor Current during t_1 : $I_{C_i,min,t_1} = -I_{max} + I_{in,avg}$

Max. Input Capacitor Current during t_1 : $I_{C_i,max,t_1} = -I_{min} + I_{in,avg}$

Input Capacitor Current during t_2 and t_3 : $I_{C_i,t_2/3} = I_{in,avg}$

Average Input Capacitor Current: $I_{C_i,avg} = 0A$

Input Capacitor Voltage: $V_{C_i} = V_{in}$

3.6. Output Capacitor C_o

3.6.1. CCM, DCM & Synchronous forced PWM.

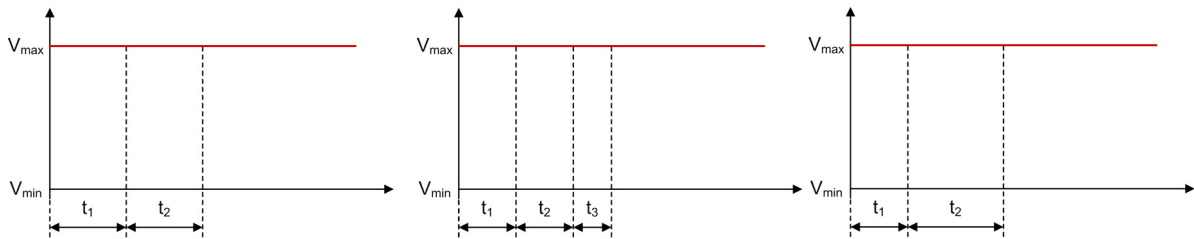

Figure 3.6.1. Buck - Output Capacitor C_o Voltage Waveforms in CCM, DCM and synchronous forced PWM

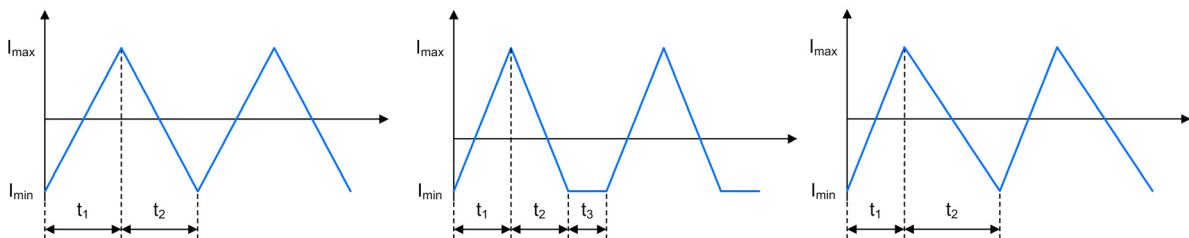

Figure 3.6.2. Buck - Output Capacitor C_o Current Waveforms in CCM, DCM and synchronous forced PWM

Min. Output Capacitor Current: $I_{C_o,min} = I_{min} - I_{out}$

Max. Output Capacitor Current: $I_{C_o,max} = I_{max} - I_{out}$

Average Output Capacitor Current: $I_{C_o,avg} = 0A$

Output Capacitor Voltage: $V_{C_o} = V_{out}$

Boost Converter

A Boost converter steps up an input voltage to a higher output voltage level. The energy is transferred to the output when the FET is not conducting.

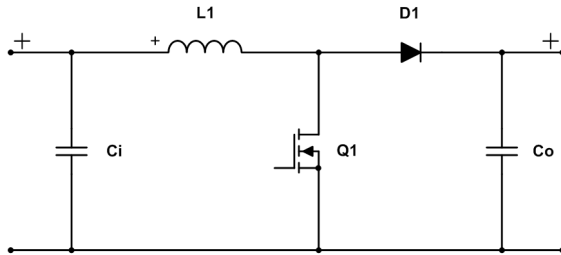

Figure 4.0.1. Schematic of a Boost converter

4.1. General

Inductor Current Ripple: $I_{ripple} = \frac{1}{L_1} \cdot V_{in} \cdot t_1$

Right Half Plane Zero: $f_{rhpz} = \frac{V_{out} \cdot (1-D)^2}{2 \cdot \pi \cdot L_1 \cdot I_{out}}$

4.1.1. CCM.

FET on, increasing current: $t_1 = \frac{1}{f_{switch}} \cdot \frac{V_{out} + V_f - V_{in}}{V_{out} + V_f}$

FET off, decreasing current: $t_2 = \frac{1}{f_{switch}} - t_1$

Average Input Current: $I_{in} = I_{out} \cdot \frac{V_{out} + V_f}{V_{in}}$

Min. Inductor Current: $I_{min} = I_{in} - \frac{I_{ripple}}{2}$

Max. Inductor Current: $I_{max} = I_{in} + \frac{I_{ripple}}{2}$

4.1.2. DCM.

FET on, increasing current: $t_1 = \sqrt{2 \cdot I_{out} \cdot L_1 \cdot \frac{V_{out} + V_f - V_{in}}{f_{switch} \cdot V_{in}^2}}$

FET off, decreasing current: $t_2 = t_1 \cdot \frac{V_{out} + V_f}{V_{out} + V_f - V_{in}} - t_1$

FET off, no current: $t_3 = \frac{1}{f_{switch}} - t_1 - t_2$

Average Input Current: $I_{in} = I_{out} \cdot \frac{V_{out} \cdot V_f}{V_{in}}$

Min. Inductor Current: $I_{min} = 0A$

Max. Inductor Current: $I_{max} = \frac{1}{L_1} \cdot V_{in} \cdot t_1$

4.2. Inductor L_1

4.2.1. CCM & DCM.

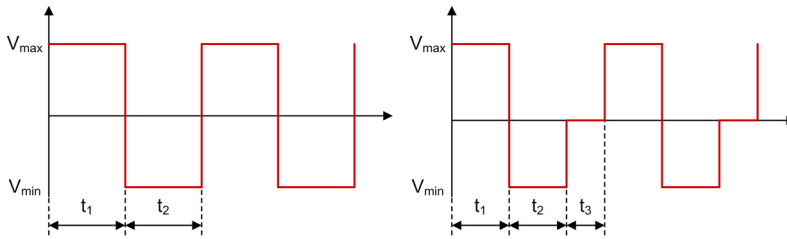

Figure 4.2.1. Boost - Inductor L_1 Voltage Waveforms in CCM and DCM

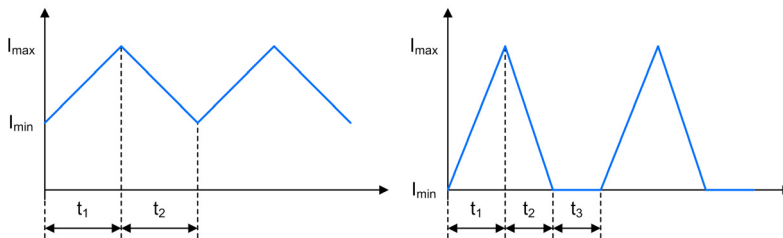

Figure 4.2.2. Boost - Inductor L_1 Current Waveforms in CCM and DCM

Average Inductor Current: $I_{L_1,avg} = \frac{I_{min} + I_{max}}{2} \cdot (t_1 + t_2) \cdot f_{switch}$

Min. Inductor Voltage: $V_{L_1,min} = V_{in} - V_{out} - V_f$

Max. Inductor Voltage: $V_{L_1,max} = V_{in}$

Inductor Voltage during t_3 : $V_{L_1,t_3} = 0V$

4.3. FET Q_1

4.3.1. CCM & DCM.

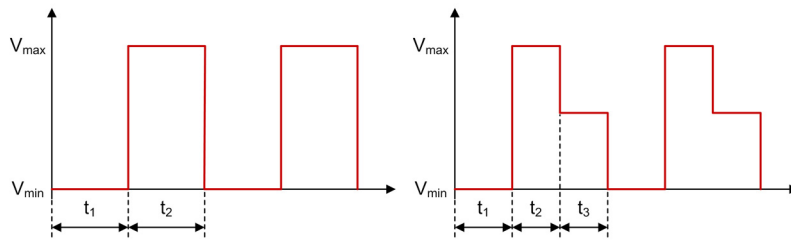

Figure 4.3.1. Boost - FET Q_1 Voltage Waveforms in CCM and DCM

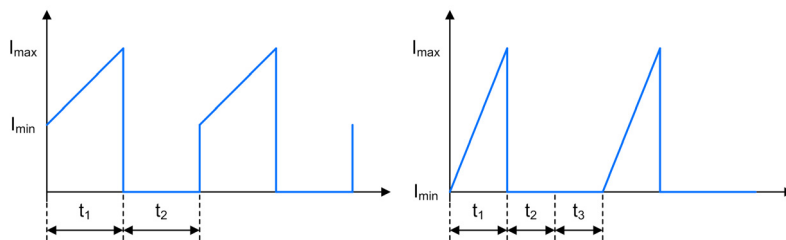

Figure 4.3.2. Boost - FET Q_1 Current Waveforms in CCM and DCM

Average FET Current: $I_{Q_1,avg} = \frac{I_{min} + I_{max}}{2} \cdot t_1 \cdot f_{switch}$

Min. FET Voltage: $V_{Q_1,min} = 0V$

Max. FET Voltage: $V_{Q_1,max} = V_{out} + V_f$

FET Voltage during t_3 : $V_{Q_1,t_3} = V_{in}$

4.4. Diode D_1

4.4.1. CCM & DCM.

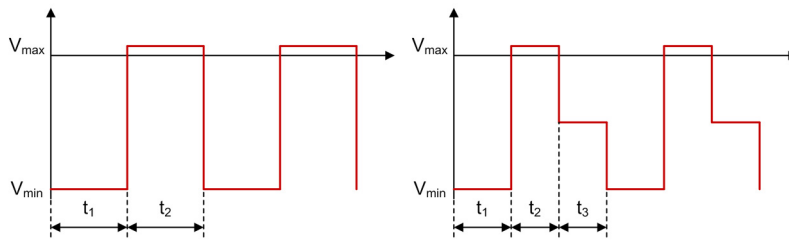

Figure 4.4.1. Boost - Diode D_1 Voltage Waveforms in CCM and DCM

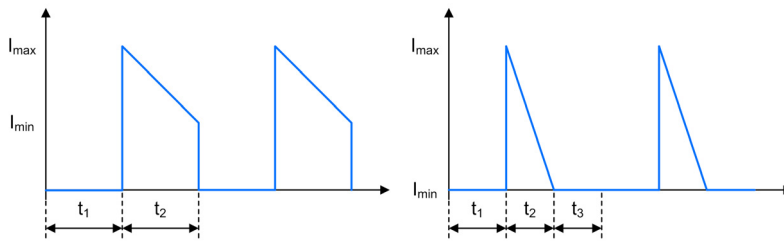

Figure 4.4.2. Boost - Diode D_1 Current Waveforms in CCM and DCM

Average Diode Current: $I_{D_1,avg} = \frac{I_{min} + I_{max}}{2} \cdot t_2 \cdot f_{switch}$

Min. Diode Voltage: $V_{D_1,min} = -V_{out}$

Max. Diode Voltage: $V_{D_1,max} = V_f$

Diode Voltage during t_3 : $V_{D_1,t_3} = V_{in} - V_{out}$

4.5. Input Capacitor C_i

4.5.1. CCM & DCM.

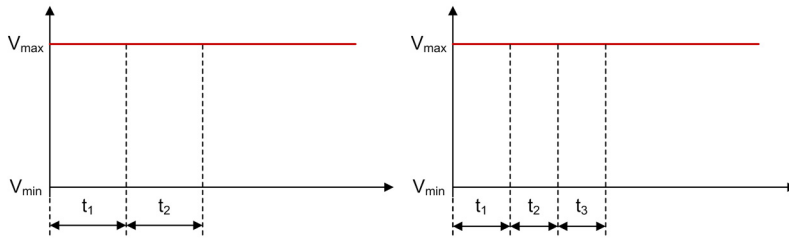

Figure 4.5.1. Boost - Input Capacitor C_i Voltage Waveforms in CCM and DCM

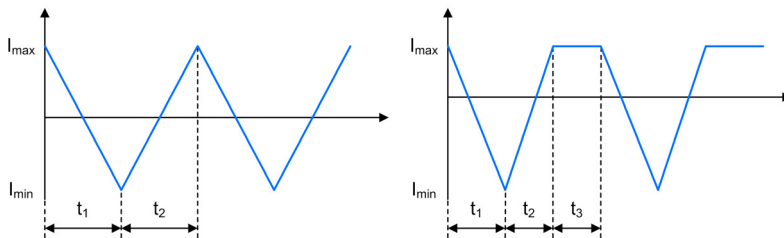

Figure 4.5.2. Boost - Input Capacitor C_i Current Waveforms in CCM and DCM

Min. Input Capacitor Current: $I_{C_i,min} = -I_{max} + I_{in}$

Max. Input Capacitor Current: $I_{C_i,max} = -I_{min} + I_{in}$

Average Input Capacitor Current: $I_{C_i,avg} = 0A$

Input Capacitor Voltage: $V_{C_i} = V_{in}$

4.6. Output Capacitor C_o

4.6.1. CCM & DCM.

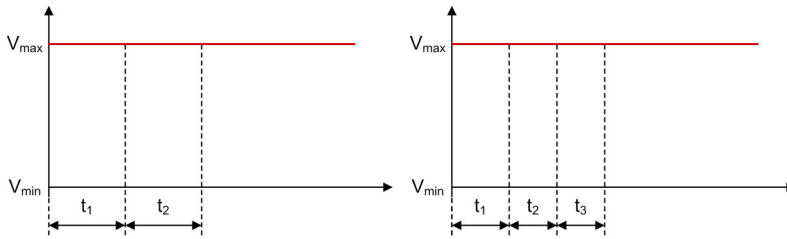

Figure 4.6.1. Boost - Output Capacitor C_o Voltage Waveforms in CCM and DCM

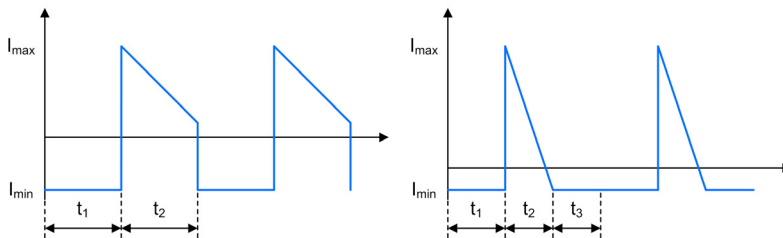

Figure 4.6.2. Boost - Output Capacitor C_o Current Waveforms in CCM and DCM

Output Capacitor Current during t_1 : $I_{C_o,t_1} = -I_{out}$

Min. Output Capacitor Current during t_2 and t_3 : $I_{C_o,min,t_2/3} = I_{min} - I_{out}$

Max. Output Capacitor Current during t_2 and t_3 : $I_{C_o,max,t_2/3} = I_{max} - I_{out}$

Average Output Capacitor Current: $I_{C_o,avg} = 0A$

Output Capacitor Voltage: $V_{C_o} = V_{out}$

Inverting Buck-Boost Converter

An Inverting Buck-Boost regulator converts a positive input voltage to a higher or lower negative output voltage level. The energy is transferred to the output when the FET is not conducting.

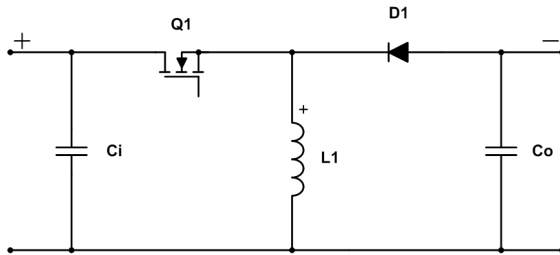

Figure 5.0.1. Schematic of an Inverting Buck-Boost converter

5.1. General

Inductor Current Ripple: $I_{ripple} = \frac{1}{L_1} \cdot V_{in} \cdot t_1$

Right Half Plane Zero: $f_{rhpz} = \frac{V_{out} \cdot (1-D)^2}{2 \cdot \pi \cdot D \cdot L_1 \cdot I_{out}}$

5.1.1. CCM.

FET on, increasing current: $t_1 = \frac{1}{f_{switch}} \cdot \frac{-V_{out} + V_f}{-V_{out} + V_f + V_{in}}$

FET off, decreasing current: $t_2 = \frac{1}{f_{switch}} - t_1$

Min. Inductor Current: $I_{min} = -I_{out} \cdot \frac{V_{in} + V_f - V_{out}}{V_{in}} - \frac{I_{ripple}}{2}$

Max. Inductor Current: $I_{max} = -I_{out} \cdot \frac{V_{in} + V_f - V_{out}}{V_{in}} + \frac{I_{ripple}}{2}$

Average Input Current: $I_{in} = \frac{V_{out} \cdot I_{out}}{V_{in}} + \frac{V_f}{V_{in}} \cdot \frac{I_{min} + I_{max}}{2} \cdot t_2 \cdot f_{switch}$

5.1.2. DCM.

FET on, increasing current: $t_1 = \sqrt{-2 \cdot I_{out} \cdot L_1 \cdot \frac{-V_{out} + V_f}{f_{switch} \cdot V_{in}^2}}$

FET off, decreasing current: $t_2 = t_1 \cdot \frac{-V_{out} + V_{in} + V_f}{-V_{out} + V_f} - t_1$

FET off, no current: $t_3 = \frac{1}{f_{switch}} - t_1 - t_2$

Min. Inductor Current: $I_{min} = 0A$

Max. Inductor Current: $I_{max} = \frac{1}{L_1} \cdot V_{in} \cdot t_1$

Average Input Current: $I_{in} = \frac{V_{out} \cdot I_{out}}{V_{in}} + \frac{V_f}{V_{in}} \cdot \frac{I_{max}}{2} \cdot t_2 \cdot f_{switch}$

5.2. Inductor L_1

5.2.1. CCM & DCM.

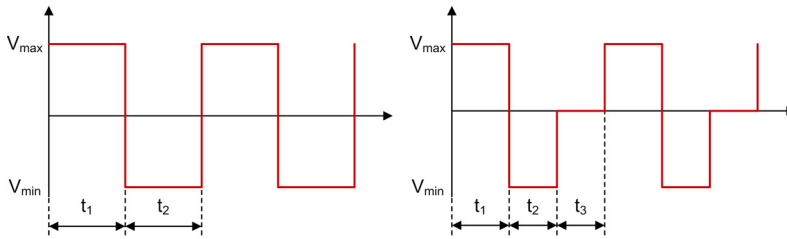

Figure 5.2.1. Inverting Buck Boost - Inductor L_1 Voltage Waveforms in CCM and DCM

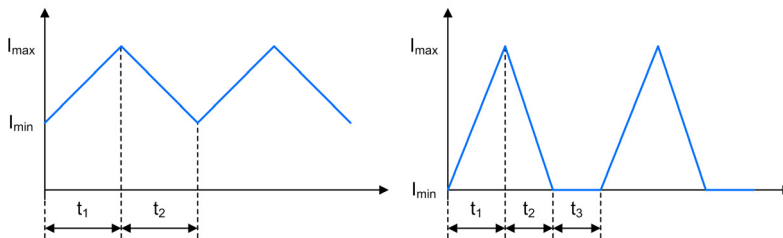

Figure 5.2.2. Inverting Buck Boost - Inductor L_1 Current Waveforms in CCM and DCM

Average Inductor Current:
$$I_{L_1,avg} = \frac{I_{min} + I_{max}}{2} \cdot (t_1 + t_2) \cdot f_{switch}$$

Min. Inductor Voltage:
$$V_{L_1,min} = V_{out} - V_f$$

Max. Inductor Voltage:
$$V_{L_1,max} = V_{in}$$

Inductor Voltage during t_3 :
$$V_{L_1,t_3} = 0V$$

5.3. FET Q_1

5.3.1. CCM & DCM.

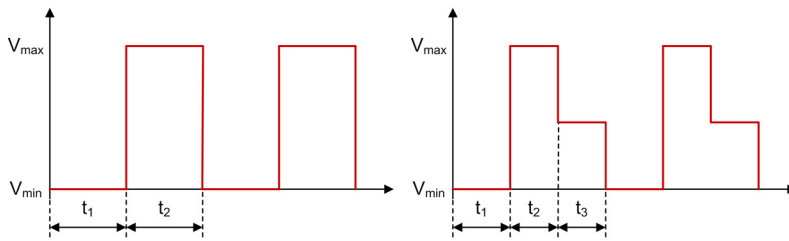

Figure 5.3.1. Inverting Buck Boost - FET Q_1 Voltage Waveforms in CCM and DCM

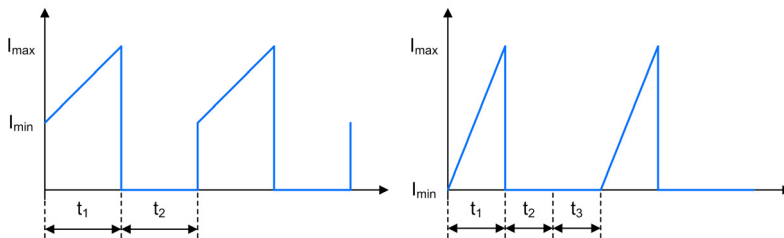

Figure 5.3.2. Inverting Buck Boost - FET Q_1 Current Waveforms in CCM and DCM

Average FET Current: $I_{Q1,avg} = \frac{I_{min} + I_{max}}{2} \cdot t_1 \cdot f_{switch}$

Min. FET Voltage: $V_{Q1,min} = 0V$

Max. FET Voltage: $V_{Q1,max} = V_{in} + V_f - V_{out}$

FET Voltage during t_3 : $V_{Q1,t3} = V_{in}$

5.4. Diode D_1

5.4.1. CCM & DCM.

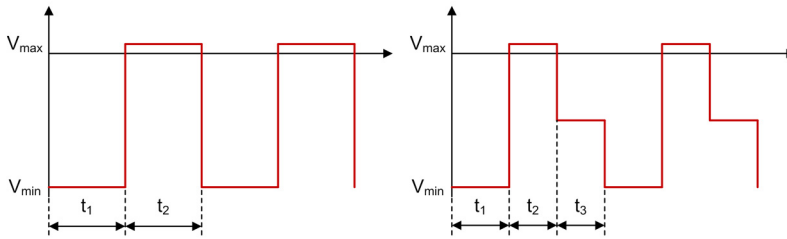

Figure 5.4.1. Inverting Buck Boost - Diode D_1 Voltage Waveforms in CCM and DCM

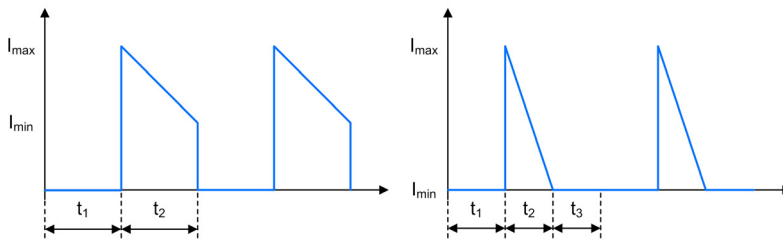

Figure 5.4.2. Inverting Buck Boost - Diode D_1 Current Waveforms in CCM and DCM

Average Diode Current:
$$I_{D_1,avg} = \frac{I_{min} + I_{max}}{2} \cdot t_2 \cdot f_{switch}$$

Min. Diode Voltage:
$$V_{D_1,min} = V_{out} - V_{in}$$

Max. Diode Voltage:
$$V_{D_1,max} = V_f$$

Diode Voltage during t_3 :
$$V_{D_1,t_3} = V_{out}$$

5.5. Input Capacitor C_i

5.5.1. CCM & DCM.

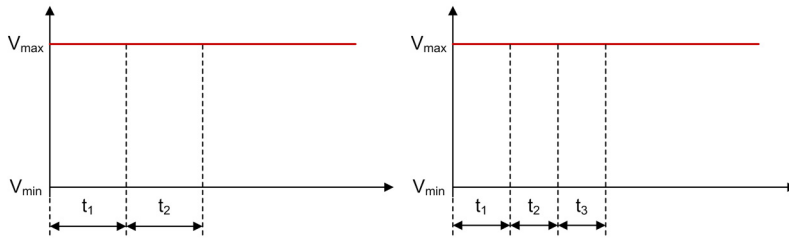

Figure 5.5.1. Inverting Buck Boost - Input Capacitor C_i Voltage Waveforms in CCM and DCM

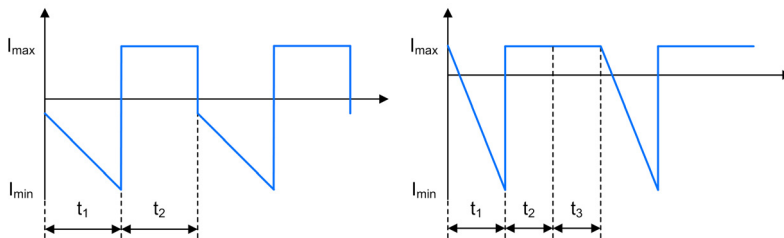

Figure 5.5.2. Inverting Buck Boost - Input Capacitor C_i Current Waveforms in CCM and DCM

Min. Input Capacitor Current during t_1 : $I_{C_i,min,t_1} = -I_{max} + I_{in}$

Max. Input Capacitor Current during t_1 : $I_{C_i,max,t_1} = -I_{min} + I_{in}$

Input Capacitor current during t_2 and t_3 : $I_{C_i,t_2/3} = I_{in}$

Average Input Capacitor Current: $I_{C_i,avg} = 0A$

Input Capacitor Voltage: $V_{C_i} = V_{in}$

5.6. Output Capacitor C_o

5.6.1. CCM & DCM.

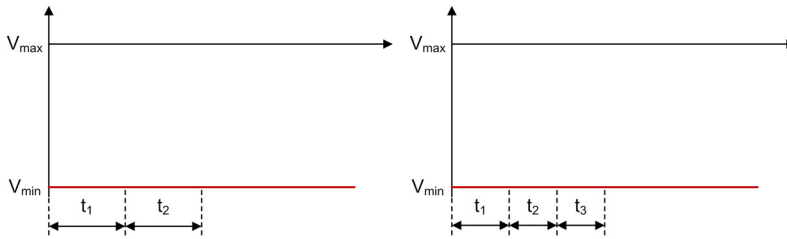

Figure 5.6.1. Inverting Buck Boost - Output Capacitor C_o Voltage Waveforms in CCM and DCM

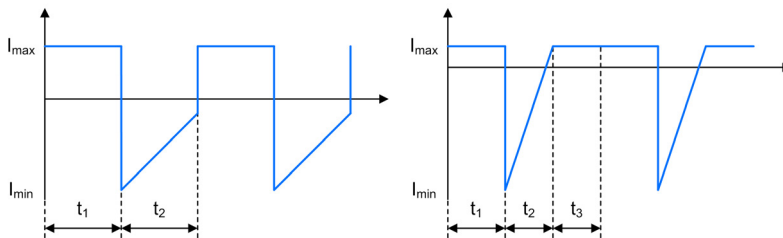

Figure 5.6.2. Inverting Buck Boost - Output Capacitor C_o Current Waveforms in CCM and DCM

Output Capacitor Current during t_1 : $I_{C_o,t_1} = -I_{out}$

Min. Output Capacitor Current during t_2 and t_3 : $I_{C_o,min,t_2/3} = -I_{min} - I_{out}$

Max. Output Capacitor Current during t_2 and t_3 : $I_{C_o,max,t_2/3} = -I_{max} - I_{out}$

Average Output Capacitor Current: $I_{C_o,avg} = 0A$

Output Capacitor Voltage: $V_{C_o} = V_{out}$

SEPIC

A Single Ended Primary Inductor Converter (SEPIC) steps up/down an input voltage to a higher/lower output voltage level. The energy is transferred to the output when the FET is not conducting.

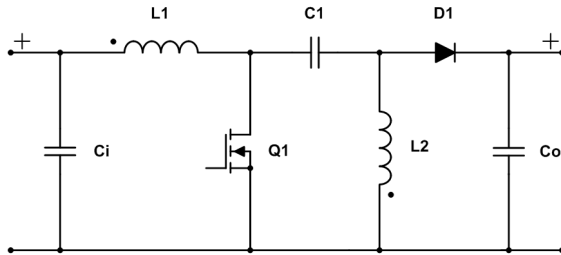

Figure 6.0.1. Schematic of a SEPIC converter

6.1. General

Right Half Plane Zero: $f_{rhpz} = \frac{V_{out} \cdot (1-D)^2}{2 \cdot \pi \cdot D^2 \cdot L_1 \cdot I_{out}}$

6.1.1. Continuous Conduction Mode.

FET on, increasing current: $t_1 = \frac{1}{f_{switch}} \cdot \frac{V_{out} + V_f}{V_{out} + V_{in} + V_f}$

FET off, decreasing current: $t_2 = \frac{1}{f_{switch}} - t_1$

Average Input Current: $I_{in,avg} = \frac{(V_{out} + V_f) \cdot I_{out}}{V_{in}}$

Inductor L_1 Ripple: $I_{L1,ripple} = V_{in} \cdot \frac{t_1}{L_1}$

Inductor L_2 Ripple: $I_{L2,ripple} = V_{in} \cdot \frac{t_1}{L_2}$

Coupling Capacitor C_1 Voltage Ripple: $V_{C1,ripple} = I_{in,avg} \cdot \frac{1-D}{C_1 \cdot f_{switch}}$

6.1.2. Discontinuous Conduction Mode.

FET on, increasing current: $t_1 = \frac{\sqrt{2 \cdot I_{out} \cdot L_1 \cdot L_2 \cdot (V_{out} + V_f) \cdot f_{switch} \cdot (L_1 + L_2)}}{V_{in} \cdot f_{switch} \cdot (L_1 + L_2)}$

FET off, decreasing current: $t_2 = \frac{\sqrt{2 \cdot I_{out} \cdot L_1 \cdot L_2 \cdot (V_{out} + V_f) \cdot f_{switch} \cdot (L_1 + L_2)}}{(V_{out} + V_f) \cdot f_{switch} \cdot (L_1 + L_2)}$

FET off, constant current: $t_3 = \frac{1}{f_{switch}} - t_1 - t_2$

Average Input Current: $I_{in,avg} = \frac{(V_{out} + V_f) \cdot I_{out}}{V_{in}}$

Inductor L_1 Ripple: $I_{L1,ripple} = V_{in} \cdot \frac{t_1}{L_1}$

Inductor L_2 Ripple: $I_{L2,ripple} = V_{in} \cdot \frac{t_1}{L_2}$

Coupling Capacitor C_1 Voltage Ripple: $V_{C1,ripple} = I_{in,avg} \cdot \frac{1-D}{C_1 \cdot f_{switch}}$

6.2. Inductor L_1

6.2.1. CCM & DCM.

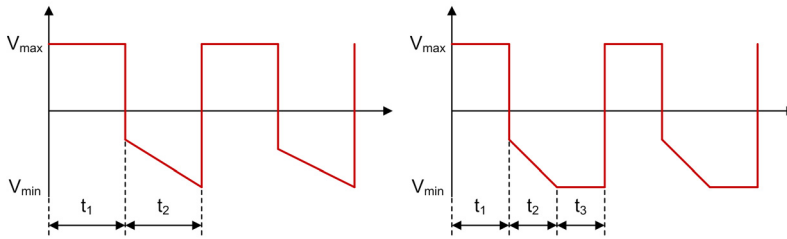

Figure 6.2.1. SEPIC - Inductor L_1 Voltage Waveforms in CCM and DCM

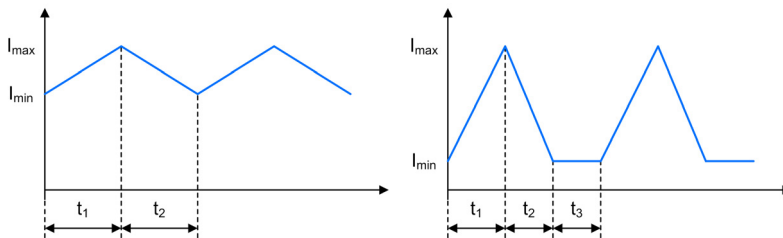

Figure 6.2.2. SEPIC - Inductor L_1 Current Waveforms in CCM and DCM

Min. Inductor Current:
$$I_{L_1,min} = I_{in,avg} - \frac{1}{2} \cdot I_{L_1,ripple} \cdot (t_1 + t_2) \cdot f_{switch}$$

Max. Inductor Current:
$$I_{L_1,max} = I_{L_1,min} + I_{L_1,ripple}$$

Average Inductor Current:
$$I_{L_1,avg} = I_{in,avg}$$

Inductor Voltage during t_1 :
$$V_{L_1,t_1} = V_{in}$$

Min. Inductor Voltage during t_2 :
$$V_{L_1,min,t_2} = -V_{out} - V_f - \frac{V_{C_1,ripple}}{2}$$

Max. Inductor Voltage during t_2 :
$$V_{L_1,max,t_2} = -V_{out} - V_f + \frac{V_{C_1,ripple}}{2}$$

Inductor Voltage during t_3 :
$$V_{L_1,t_3} = 0V$$

The offset in DCM during t_3 is dependent on the input voltage and can be positive or negative.

6.3. Inductor L_2

6.3.1. CCM.

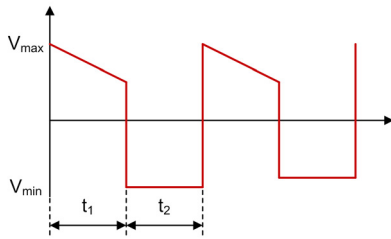

Figure 6.3.1. SEPIC - Inductor L_2 Voltage Waveform in CCM

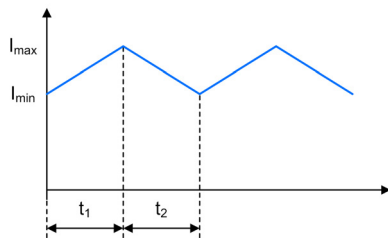

Figure 6.3.2. SEPIC - Inductor L_2 Current Waveform in CCM

Min. Inductor Current: $I_{L_2,min} = I_{out} - \frac{I_{L_2,ripple}}{2}$

Max. Inductor Current: $I_{L_2,max} = I_{L_2,min} + I_{L_2,ripple}$

Average Inductor Current: $I_{L_2,avg} = I_{out}$

Min. Inductor Voltage during t_1 : $V_{L_2,min,t_1} = V_{in} - \frac{V_{C_1,ripple}}{2}$

Max. Inductor Voltage during t_1 : $V_{L_2,max,t_1} = V_{in} + \frac{V_{C_1,ripple}}{2}$

Inductor Voltage during t_2 : $V_{L_2,t_2} = -V_{out} - V_f$

6.3.2. DCM.

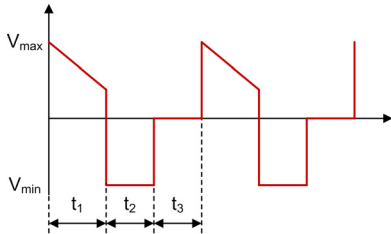

Figure 6.3.3. SEPIC - Inductor L_2 Voltage Waveform in DCM

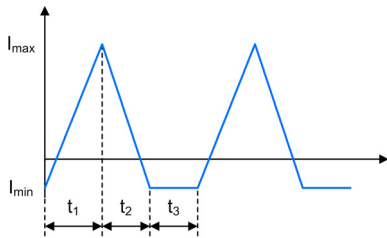

Figure 6.3.4. SEPIC - Inductor L_2 Current Waveform in DCM

- Min. Inductor Current: $I_{L2,min} = -I_{L1,min}$
- Max. Inductor Current: $I_{L2,max} = I_{L2,min} + I_{L2,ripple}$
- Average Inductor Current: $I_{L2,avg} = I_{out}$
- Min. Inductor Voltage during t_1 : $V_{L2,min,t1} = V_{in} - \frac{V_{C1,ripple}}{2}$
- Max. Inductor Voltage during t_1 : $V_{L2,max,t1} = V_{in} + \frac{V_{C1,ripple}}{2}$
- Inductor Voltage during t_2 : $V_{L2,t2} = -V_{out} - V_f$
- Inductor Voltage during t_3 : $V_{L2,t3} = 0V$

The offset in DCM during t_3 is dependent on the input voltage and can be positive or negative.

6.4. FET Q_1

6.4.1. CCM & DCM.

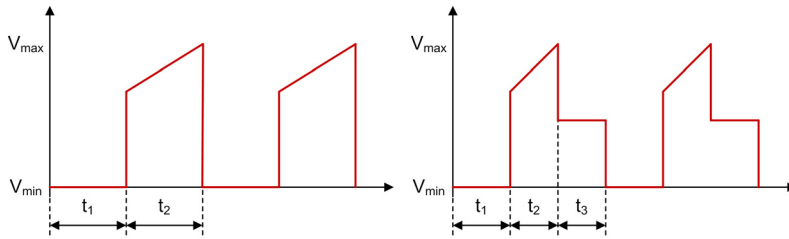

Figure 6.4.1. SEPIC - FET Q_1 Voltage Waveforms in CCM and DCM

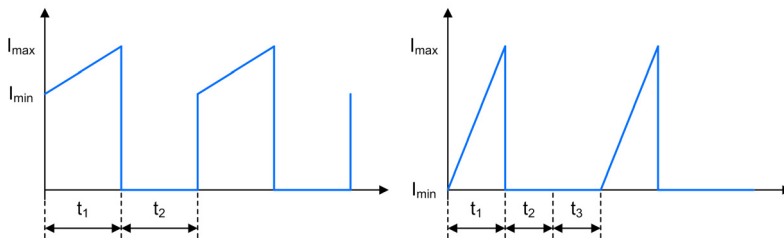

Figure 6.4.2. SEPIC - FET Q_1 Current Waveforms in CCM and DCM

Min. FET Current:	$I_{Q_1,min} = I_{L_1,min} + I_{L_2,min}$
Max. FET Current:	$I_{Q_1,max} = I_{L_1,max} + I_{L_2,max}$
Average FET Current:	$I_{Q_1,avg} = I_{in,avg}$
FET Voltage during t_1 :	$V_{Q_1,t_1} = 0V$
Min. FET Voltage during t_2 :	$V_{Q_1,min,t_2} = V_{in} + V_{out} + V_f - \frac{V_{C_1,ripple}}{2}$
Max. FET Voltage during t_2 :	$V_{Q_1,max,t_2} = V_{in} + V_{out} + V_f + \frac{V_{C_1,ripple}}{2}$
FET Voltage during t_3 :	$V_{Q_1,t_3} = V_{in}$

6.5. Diode D_1

6.5.1. CCM & DCM.

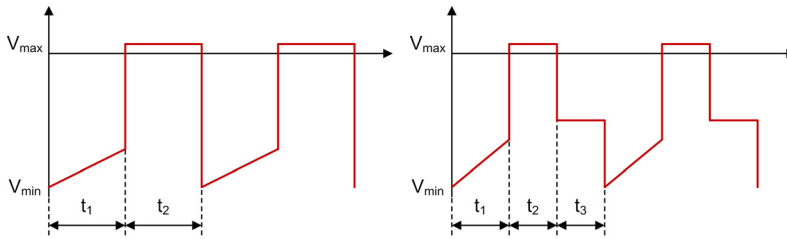

Figure 6.5.1. SEPIC - Diode D_1 Voltage Waveforms in CCM and DCM

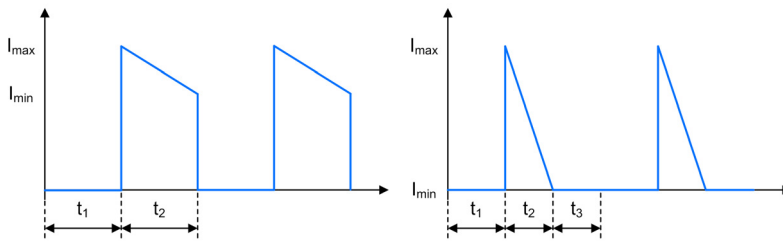

Figure 6.5.2. SEPIC - Diode D_1 Current Waveforms in CCM and DCM

Min. Diode Current: $I_{D_1,min} = I_{L_1,min} + I_{L_2,min}$

Max. Diode Current: $I_{D_1,max} = I_{L_1,max} + I_{L_2,max}$

Average Diode Current: $I_{D_1,avg} = I_{out}$

Min. Diode Voltage during t_1 : $V_{D_1,min,t_1} = -V_{in} - V_{out} - \frac{V_{C_1,ripple}}{2}$

Max. Diode Voltage during t_1 : $V_{D_1,max,t_1} = -V_{in} - V_{out} + \frac{V_{C_1,ripple}}{2}$

Diode Voltage during t_2 : $V_{D_1,t_2} = V_f$

Diode Voltage during t_3 : $V_{D_1,t_3} = -V_{out}$

6.6. Coupling Capacitor C_1

6.6.1. CCM & DCM.

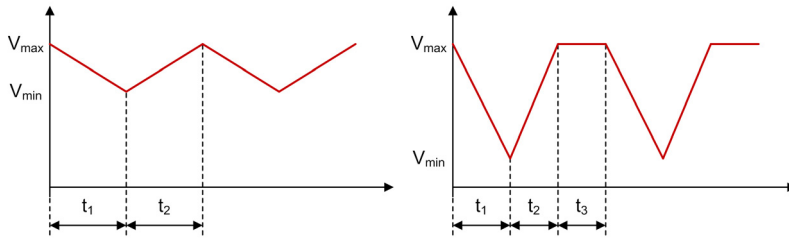

Figure 6.6.1. SEPIC - Coupling Capacitor C_1 Voltage Waveforms in CCM and DCM

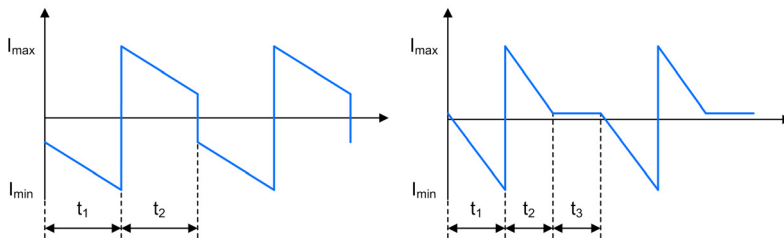

Figure 6.6.2. SEPIC - Coupling Capacitor C_1 Current Waveforms in CCM and DCM

Min. Coupling Capacitor Current during t_1 : $I_{C_1,min,t_1} = I_{L_1,max} - I_{fet,max}$

Max. Coupling Capacitor Current during t_1 : $I_{C_1,max,t_1} = I_{L_1,min} - I_{fet,min}$

Min. Coupling Capacitor Current during t_2 : $I_{C_1,min,t_2} = I_{L_1,min}$

Max. Coupling Capacitor Current during t_2 : $I_{C_1,max,t_2} = I_{L_1,max}$

Coupling Capacitor Current during t_3 : $I_{C_1,t_3} = I_{L_1,min}$

Average Coupling Capacitor Current: $I_{C_1,avg} = 0A$

Min. Coupling Capacitor Voltage: $V_{C_1,min} = V_{in} - \frac{V_{C_1,ripple}}{2}$

Max. Coupling Capacitor Voltage: $V_{C_1,max} = V_{in} + \frac{V_{C_1,ripple}}{2}$

Coupling Capacitor Voltage during t_3 : $V_{C_1,t_3} = V_{in}$

6.7. Input Capacitor C_i

6.7.1. CCM & DCM.

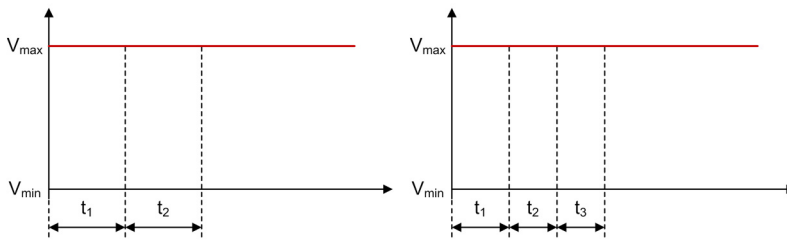

Figure 6.7.1. SEPIC - Input Capacitor C_i Voltage Waveforms in CCM and DCM

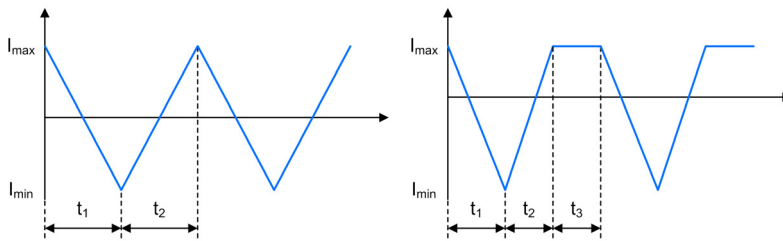

Figure 6.7.2. SEPIC - Input Capacitor C_i Current Waveforms in CCM and DCM

Min. Input Capacitor Current: $I_{C_i,min} = I_{in,avg} - I_{L_1,max}$

Max. Input Capacitor Current: $I_{C_i,max} = I_{in,avg} - I_{L_1,min}$

Average Input Capacitor Current: $I_{C_i,avg} = 0A$

Input Capacitor Voltage: $V_{C_i} = V_{in}$

6.8. Output Capacitor C_o

6.8.1. CCM & DCM.

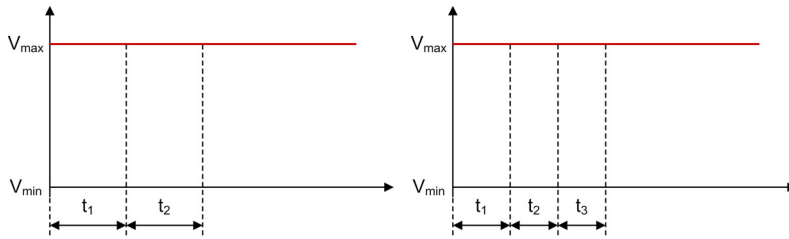

Figure 6.8.1. SEPIC - Output Capacitor C_o Voltage Waveforms in CCM and DCM

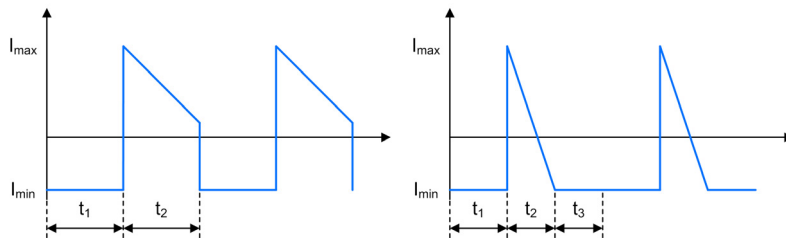

Figure 6.8.2. SEPIC - Output Capacitor C_o Current Waveforms in CCM and DCM

Output Capacitor Current during t_1 :

$$I_{C_o,t_1} = -I_{out}$$

Min. Output Capacitor Current during t_2 and t_3 :

$$I_{C_o,min,t_2/3} = I_{L_1,min} + I_{L_2,min} - I_{out}$$

Max. Output Capacitor Current during t_2 and t_3 :

$$I_{C_o,max,t_2/3} = I_{L_1,max} + I_{L_2,max} - I_{out}$$

Average Output Capacitor Current:

$$I_{C_o,avg} = 0A$$

Output Capacitor Voltage:

$$V_{C_o} = V_{out}$$

Cuk Converter

A Cuk regulator converts a positive input voltage to a higher or lower negative output voltage level. The energy is transferred to the output when the FET is not conducting.

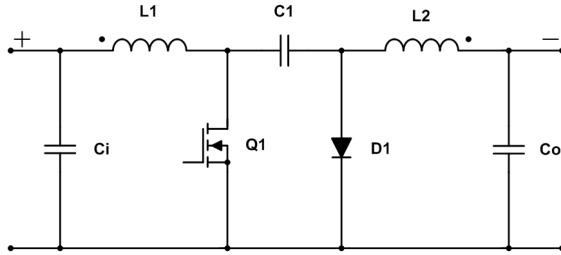

Figure 7.0.1. Schematic of a Cuk converter

7.1. General

Right Half Plane Zero: $f_{rhpz} = \frac{1}{2\pi} \cdot \sqrt{\frac{1-D}{L_1 \cdot C_1}}$

7.1.1. Continuous Conduction Mode.

FET on, increasing current: $t_1 = \frac{1}{f_{switch}} \cdot \frac{-V_{out} + V_f}{-V_{out} + V_{in} + V_f}$

FET off, decreasing current: $t_2 = \frac{1}{f_{switch}} - t_1$

Average Input Current: $I_{in,avg} = \frac{(V_{out} - V_f) \cdot I_{out}}{V_{in}}$

Inductor L_1 Ripple: $I_{L_1,ripple} = V_{in} \cdot \frac{t_1}{L_1}$

Inductor L_2 Ripple: $I_{L_2,ripple} = V_{in} \cdot \frac{t_1}{L_2}$

Coupling Capacitor C_1 Voltage Ripple: $V_{C_1,ripple} = I_{in,avg} \cdot \frac{1-D}{C_1 \cdot f_{switch}}$

7.1.2. Discontinuous Conduction Mode.

FET on, increasing current: $t_1 = \frac{V_{in} \cdot \sqrt{2 \cdot (-I_{out}) \cdot |V_{out} - V_f| \cdot (V_{in} - V_{out} + V_f) \cdot f_{switch} \cdot (L_1 + L_2) \cdot (V_{in} + |V_{out} - V_f|) \cdot L_1 \cdot L_2}}{(V_{in}^3 + V_{in}^2 \cdot |V_{out} - V_f|) \cdot f_{switch} \cdot (L_1 + L_2)}$

FET off, decreasing current: $t_2 = \frac{L_1 \cdot L_2 \cdot \sqrt{2 \cdot (-I_{out}) \cdot |V_{out} - V_f| \cdot (V_{in} - V_{out} + V_f) \cdot f_{switch} \cdot (L_1 + L_2) \cdot (V_{in} + |V_{out} - V_f|) \cdot \frac{1}{L_1 \cdot L_2}}{|V_{out} - V_f| \cdot f_{switch} \cdot (L_1 + L_2) \cdot (V_{in} + |V_{out} - V_f|)}$

FET off, constant current: $t_3 = \frac{1}{f_{switch}} - t_1 - t_2$

Average Input Current: $I_{in,avg} = \frac{(V_{out} - V_f) \cdot I_{out}}{V_{in}}$

Inductor L_1 Ripple: $I_{L_1,ripple} = V_{in} \cdot \frac{t_1}{L_1}$

Inductor L_2 Ripple: $I_{L_2,ripple} = V_{in} \cdot \frac{t_1}{L_2}$

Coupling Capacitor C_1 Voltage Ripple: $V_{C_1,ripple} = I_{in,avg} \cdot \frac{1-D}{C_1 \cdot f_{switch}}$

7.2. Inductor L_1

7.2.1. CCM & DCM.

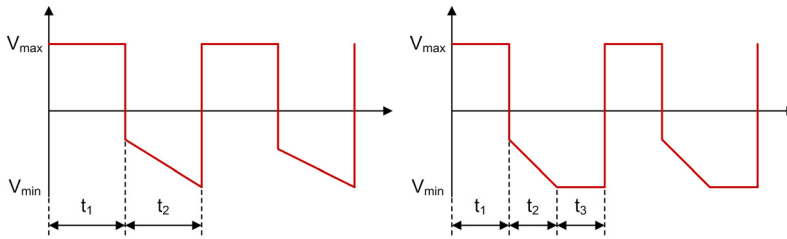

Figure 7.2.1. Cuk - Inductor L_1 Voltage Waveforms in CCM and DCM

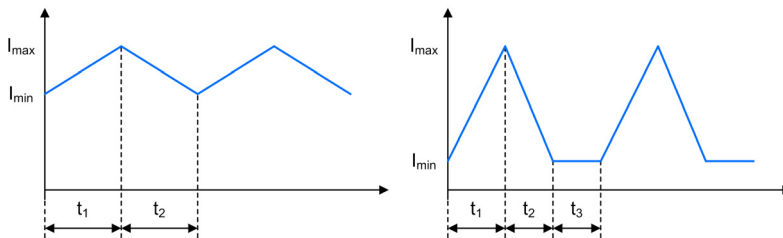

Figure 7.2.2. Cuk - Inductor L_1 Current Waveforms in CCM and DCM

Min. Inductor Current:
$$I_{L_1,min} = I_{in,avg} - \frac{1}{2} \cdot I_{L_1,ripple} \cdot (t_1 + t_2) \cdot f_{switch}$$

Max. Inductor Current:
$$I_{L_1,max} = I_{L_1,min} + I_{L_1,ripple}$$

Average Inductor Current:
$$I_{L_1,avg} = I_{in,avg}$$

Inductor Voltage during t_1 :
$$V_{L_1,t_1} = V_{in}$$

Min. Inductor Voltage during t_2 :
$$V_{L_1,min,t_2} = V_{out} - V_f - \frac{V_{C_1,ripple}}{2}$$

Max. Inductor Voltage during t_2 :
$$V_{L_1,max,t_2} = V_{out} - V_f + \frac{V_{C_1,ripple}}{2}$$

Inductor Voltage during t_3 :
$$V_{L_1,t_3} = 0V$$

The offset in DCM during t_3 is dependent on the input voltage and can be positive or negative.

7.3. Inductor L_2

7.3.1. CCM.

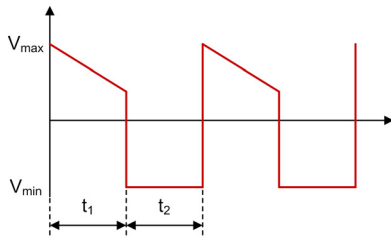

Figure 7.3.1. Cuk - Inductor L_2 Voltage Waveform in CCM

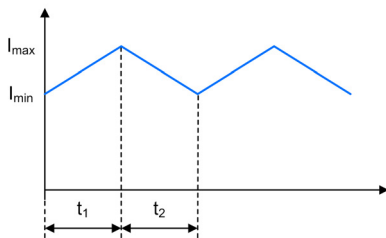

Figure 7.3.2. Cuk - Inductor L_2 Current Waveform in CCM

Max. Inductor Current:	$I_{L_2,max} = I_{out} + \frac{I_{L_2,ripple}}{2}$
Min. Inductor Current:	$I_{L_2,min} = I_{L_2,max} - I_{L_2,ripple}$
Average Inductor Current:	$I_{L_2,avg} = I_{out}$
Min. Inductor Voltage during t_1 :	$V_{L_2,min,t_1} = -V_{in} - \frac{V_{C_1,ripple}}{2}$
Max. Inductor Voltage during t_1 :	$V_{L_2,max,t_1} = -V_{in} + \frac{V_{C_1,ripple}}{2}$
Inductor Voltage during t_2 :	$V_{L_2,t_2} = V_{out} - V_f$

7.3.2. DCM.

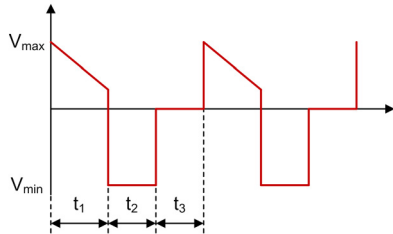

Figure 7.3.3. Cuk - Inductor L_2 Voltage Waveform in DCM

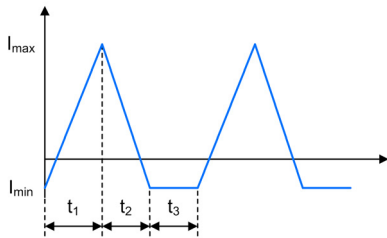

Figure 7.3.4. Cuk - Inductor L_2 Current Waveform in DCM

- Min. Inductor Current: $I_{L_2,min} = -I_{L_1,min}$
- Max. Inductor Current: $I_{L_2,max} = I_{L_2,min} + I_{L_2,ripple}$
- Average Inductor Current: $I_{L_2,avg} = I_{out}$
- Min. Inductor Voltage during t_1 : $V_{L_2,min,t_1} = -V_{in} - \frac{V_{C_1,ripple}}{2}$
- Max. Inductor Voltage during t_1 : $V_{L_2,max,t_1} = -V_{in} + \frac{V_{C_1,ripple}}{2}$
- Inductor Voltage during t_2 : $V_{L_2,t_2} = V_{out} - V_f$
- Inductor Voltage during t_3 : $V_{L_2,t_3} = 0V$

The offset of the current in DCM during t_3 is dependent on the input voltage and can be positive or negative.

7.4. FET Q_1

7.4.1. CCM & DCM.

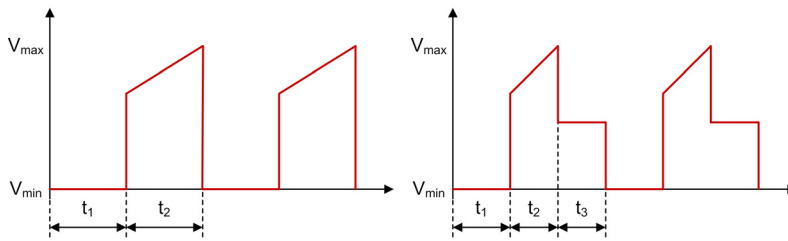

Figure 7.4.1. Cuk - FET Q_1 Voltage Waveforms in CCM and DCM

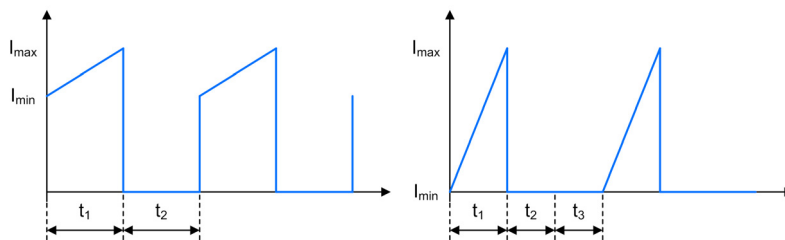

Figure 7.4.2. Cuk - FET Q_1 Current Waveforms in CCM and DCM

Min. FET Current: $I_{Q_1,min} = I_{L_1,min} - I_{L_2,max}$

Max. FET Current: $I_{Q_1,max} = I_{L_1,max} - I_{L_2,min}$

Average FET Current: $I_{Q_1,avg} = I_{in,avg}$

FET Voltage during t_1 : $V_{Q_1,t_1} = 0V$

Min. FET Voltage during t_2 : $V_{Q_1,min,t_2} = V_{in} - V_{out} + V_f - \frac{V_{C_1,ripple}}{2}$

Max. FET Voltage during t_2 : $V_{Q_1,max,t_2} = V_{in} - V_{out} + V_f + \frac{V_{C_1,ripple}}{2}$

FET Voltage during t_3 : $V_{Q_1,t_3} = V_{in}$

7.5. Diode D_1

7.5.1. CCM & DCM.

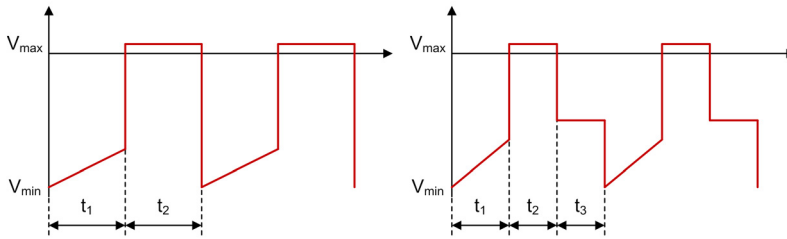

Figure 7.5.1. Cuk - Diode D_1 Voltage Waveforms in CCM and DCM

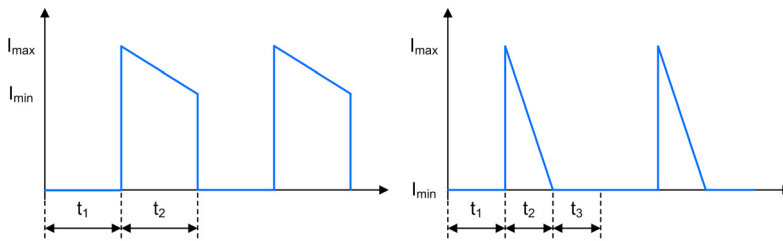

Figure 7.5.2. Cuk - Diode D_1 Current Waveforms in CCM and DCM

Min. Diode Current: $I_{D1,min} = I_{L1,min} - I_{L2,max}$

Max. Diode Current: $I_{D1,max} = I_{L1,max} - I_{L2,min}$

Average Diode Current: $I_{D1,avg} = I_{out}$

Min. Diode Voltage during t_1 : $V_{D1,min,t1} = -V_{in} + V_{out} - \frac{V_{C1,ripple}}{2}$

Max. Diode Voltage during t_1 : $V_{D1,max,t1} = -V_{in} + V_{out} + \frac{V_{C1,ripple}}{2}$

Diode Voltage during t_2 : $V_{D1,t2} = V_f$

Diode Voltage during t_3 : $V_{D1,t3} = V_{out}$

7.6. Coupling Capacitor C_1

7.6.1. CCM & DCM.

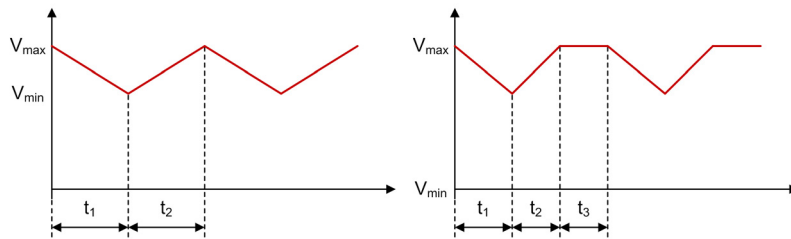

Figure 7.6.1. Cuk - Coupling Capacitor C_1 Voltage Waveforms in CCM and DCM

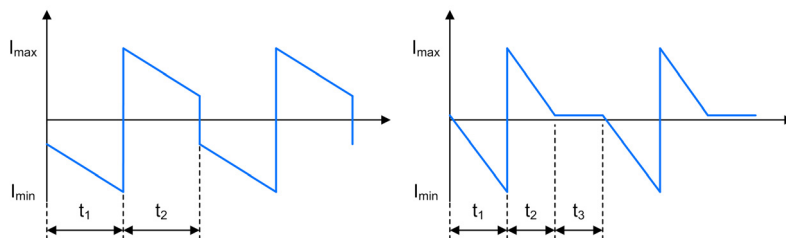

Figure 7.6.2. Cuk - Coupling Capacitor C_1 Current Waveforms in CCM and DCM

Min. Coupling Capacitor Current during t_1 : $I_{C_1,min,t_1} = I_{L_1,max} - I_{fet,max}$

Max. Coupling Capacitor Current during t_1 : $I_{C_1,max,t_1} = I_{L_1,min} - I_{fet,min}$

Min. Coupling Capacitor Current during t_2 : $I_{C_1,min,t_2} = I_{L_1,min}$

Max. Coupling Capacitor Current during t_2 : $I_{C_1,max,t_2} = I_{L_1,max}$

Average Coupling Capacitor Current: $I_{C_1,avg} = 0A$

Min. Coupling Capacitor Voltage: $V_{C_1,min} = V_{in} - V_{out} - \frac{V_{C_1,ripple}}{2}$

Max. Coupling Capacitor Voltage: $V_{C_1,max} = V_{in} - V_{out} + \frac{V_{C_1,ripple}}{2}$

Coupling Capacitor Voltage during t_3 : $V_{C_1,t_3} = V_{in} - V_{out} + \frac{V_{C_1,ripple}}{2}$

7.7. Input Capacitor C_i

7.7.1. CCM & DCM.

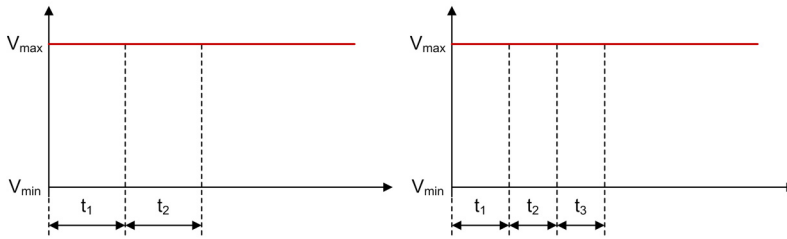

Figure 7.7.1. Cuk - Input Capacitor C_i Voltage Waveforms in CCM and DCM

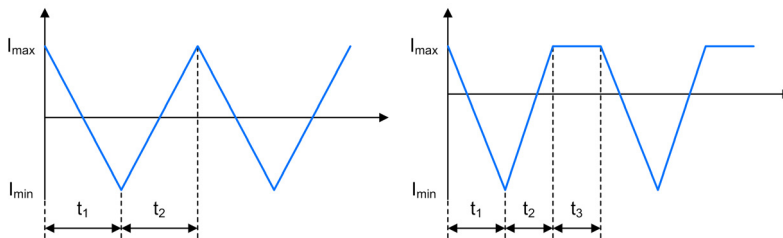

Figure 7.7.2. Cuk - Input Capacitor C_i Current Waveforms in CCM and DCM

Min. Input Capacitor Current: $I_{C_i,min} = I_{in,avg} - I_{L1,max}$

Max. Input Capacitor Current: $I_{C_i,max} = I_{in,avg} - I_{L1,min}$

Average Input Capacitor Current: $I_{C_i,avg} = 0A$

Input Capacitor Voltage: $V_{C_i} = V_{in}$

7.8. Output Capacitor C_o

7.8.1. CCM & DCM.

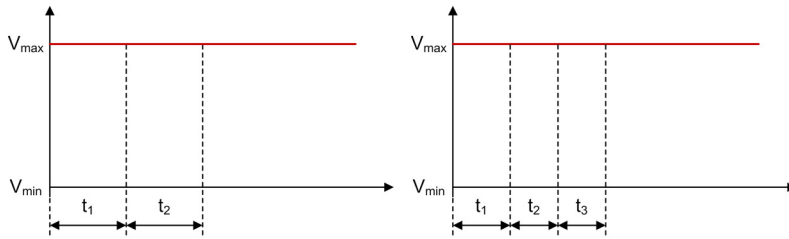

Figure 7.8.1. Cuk - Output Capacitor C_o Voltage Waveforms in CCM and DCM

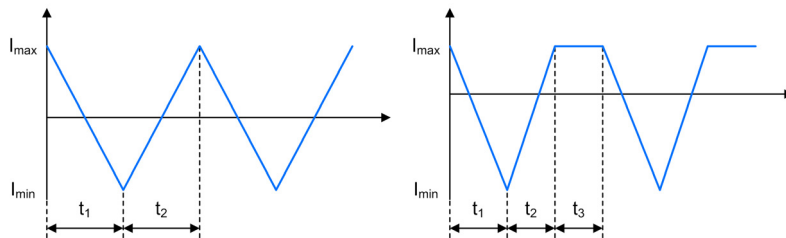

Figure 7.8.2. Cuk - Output Capacitor C_o Current Waveforms in CCM and DCM

Min. Output Capacitor Current: $I_{C_o,min} = -I_{out} + I_{L2,min}$

Max. Output Capacitor Current: $I_{C_o,max} = -I_{out} + I_{L2,max}$

Average Output Capacitor Current: $I_{C_o,avg} = 0A$

Output Capacitor Voltage: $V_{C_o} = V_{out}$

Zeta Converter

A Zeta converter steps up/down an input voltage to a higher/lower output voltage level. The energy is transferred to the output when the switch is conducting.

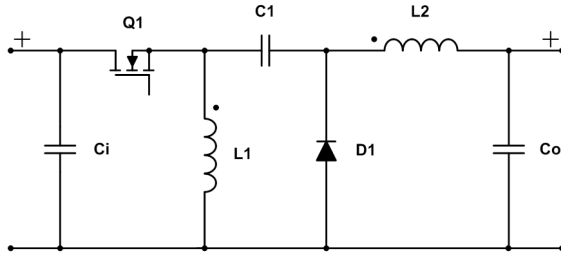

Figure 8.0.1. Schematic of a Zeta converter

8.1. General

8.1.1. Continuous Conduction Mode.

FET on, increasing current:

$$t_1 = \frac{1}{f_{switch}} \cdot \frac{V_{out} + V_f}{V_{out} + V_{in} + V_f}$$

FET off, decreasing current:

$$t_2 = \frac{1}{f_{switch}} - t_1$$

Average Input Current:

$$I_{in,avg} = \frac{(V_{out} + V_f) \cdot I_{out}}{V_{in}}$$

Inductor L_1 Ripple:

$$I_{L1,ripple} = V_{in} \cdot \frac{t_1}{L_1}$$

Inductor L_2 Ripple:

$$I_{L2,ripple} = V_{in} \cdot \frac{t_1}{L_2}$$

Coupling Capacitor C_1 Voltage Ripple:

$$V_{C1,ripple} = I_{in,avg} \cdot \frac{1-D}{C_1 \cdot f_{switch}}$$

8.1.2. Discontinuous Conduction Mode.

FET on, increasing current:

$$t_1 = \frac{\sqrt{2 \cdot I_{out} \cdot L_1 \cdot L_2 \cdot (V_{out} + V_f) \cdot f_{switch} \cdot (L_1 + L_2)}}{V_{in} \cdot f_{switch} \cdot (L_1 + L_2)}$$

FET off, decreasing current:

$$t_2 = \frac{\sqrt{2 \cdot I_{out} \cdot L_1 \cdot L_2 \cdot (V_{out} + V_f) \cdot f_{switch} \cdot (L_1 + L_2)}}{(V_{out} + V_f) \cdot f_{switch} \cdot (L_1 + L_2)}$$

FET off, constant current:

$$t_3 = \frac{1}{f_{switch}} - t_1 - t_2$$

Average Input Current:

$$I_{in,avg} = \frac{(V_{out} + V_f) \cdot I_{out}}{V_{in}}$$

Inductor L_1 Ripple:

$$I_{L1,ripple} = V_{in} \cdot \frac{t_1}{L_1}$$

Inductor L_2 Ripple:

$$I_{L2,ripple} = V_{in} \cdot \frac{t_1}{L_2}$$

Coupling Capacitor C_1 Voltage Ripple:

$$V_{C1,ripple} = I_{in,avg} \cdot \frac{1-D}{C_1 \cdot f_{switch}}$$

8.2. Inductor L_1

8.2.1. CCM & DCM.

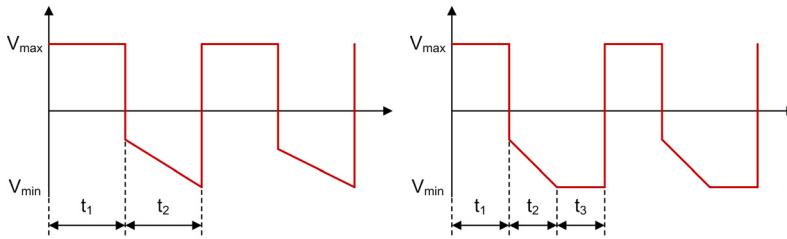

Figure 8.2.1. Zeta - Inductor L_1 Voltage Waveforms in CCM and DCM

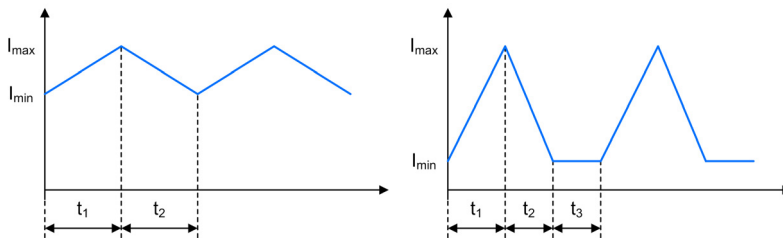

Figure 8.2.2. Zeta - Inductor L_1 Current Waveforms in CCM and DCM

Min. Inductor Current:
$$I_{L1,min} = I_{in,avg} - \frac{1}{2} \cdot I_{L1,ripple} \cdot (t_1 + t_2) \cdot f_{switch}$$

Max. Inductor Current:
$$I_{L1,max} = I_{L1,min} + I_{L1,ripple}$$

Average Inductor Current:
$$I_{L1,avg} = I_{in,avg}$$

Inductor Voltage during t_1 :
$$V_{L1,on} = V_{in}$$

Min. Inductor Voltage during t_2 :
$$V_{L1,min,t_2} = -V_{out} - V_f - \frac{V_{C1,ripple}}{2}$$

Max. Inductor Voltage during t_2 :
$$V_{L1,max,t_2} = -V_{out} - V_f + \frac{V_{C1,ripple}}{2}$$

Inductor Voltage during t_3 :
$$V_{L1,t_3} = 0V$$

The offset of the current in DCM during t_3 is dependent on the input voltage and can be positive or negative.

8.3. Inductor L_2

8.3.1. CCM.

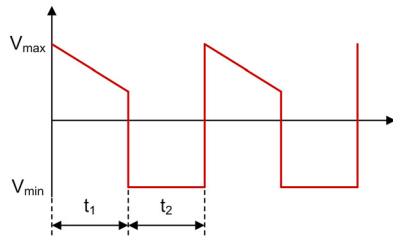

Figure 8.3.1. Zeta - Inductor L_2 Voltage Waveform in CCM

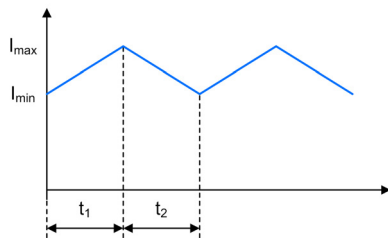

Figure 8.3.2. Zeta - Inductor L_2 Current Waveform in CCM

Min. Inductor Current:	$I_{L2,min} = I_{out} - \frac{I_{L2,ripple}}{2}$
Max. Inductor Current:	$I_{L2,max} = I_{L2,min} + I_{L2,ripple}$
Average Inductor Current:	$I_{L2,avg} = I_{out}$
Min. Inductor Voltage during t_1 :	$V_{L2,min,t_1} = V_{in} - \frac{V_{C1,ripple}}{2}$
Max. Inductor Voltage during t_1 :	$V_{L2,max,t_1} = V_{in} + \frac{V_{C1,ripple}}{2}$
Inductor Voltage during t_2 :	$V_{L2,t_2} = -V_{out} - V_f$

8.3.2. DCM.

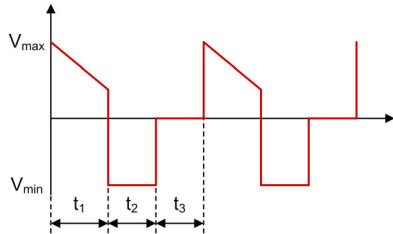

Figure 8.3.3. Zeta - Inductor L_2 Voltage Waveform in DCM

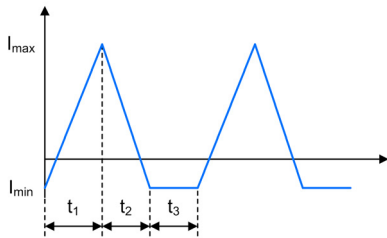

Figure 8.3.4. Zeta - Inductor L_2 Current Waveform in DCM

- Min. Inductor Current: $I_{L_2,min} = -I_{L_1,min}$
- Max. Inductor Current: $I_{L_2,max} = I_{L_2,min} + I_{L_2,ripple}$
- Average Inductor Current: $I_{L_2,avg} = I_{out}$
- Min. Inductor Voltage during t_1 : $V_{L_2,min,t_1} = V_{in} - \frac{V_{C_1,ripple}}{2}$
- Max. Inductor Voltage during t_1 : $V_{L_2,max,t_1} = V_{in} + \frac{V_{C_1,ripple}}{2}$
- Inductor Voltage during t_2 : $V_{L_2,t_2} = -V_{out} - V_f$
- Inductor Voltage during t_3 : $V_{L_2,t_3} = 0V$

The offset of the current in DCM during t_3 is dependent on the input voltage and can be positive or negative.

8.4. FET Q_1

8.4.1. CCM & DCM.

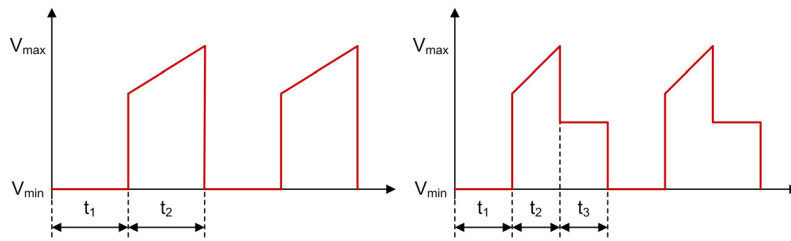

Figure 8.4.1. Zeta - FET Q_1 Voltage Waveforms in CCM and DCM

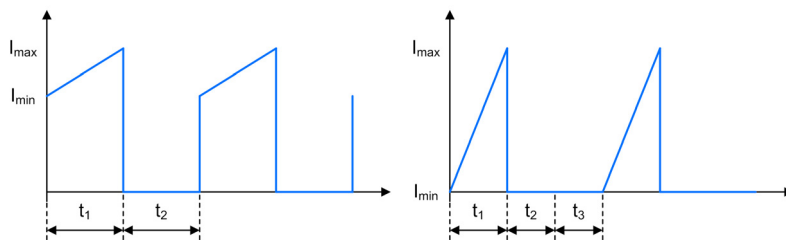

Figure 8.4.2. Zeta - FET Q_1 Current Waveforms in CCM and DCM

Min. FET Current: $I_{Q_1,min} = I_{L_1,min} + I_{L_2,min}$

Max. FET Current: $I_{Q_1,max} = I_{L_1,max} + I_{L_2,max}$

Average FET Current: $I_{Q_1,avg} = I_{in,avg}$

FET Voltage during t_1 : $V_{Q_1,t_1} = 0V$

Min. FET Voltage during t_2 : $V_{Q_1,min,t_2} = V_{in} + V_{out} + V_f - \frac{V_{C_1,ripple}}{2}$

Max. FET Voltage during t_2 : $V_{Q_1,max,t_2} = V_{in} + V_{out} + V_f + \frac{V_{C_1,ripple}}{2}$

FET Voltage during t_3 : $V_{Q_1,t_3} = V_{in}$

8.5. Diode D_1

8.5.1. CCM & DCM.

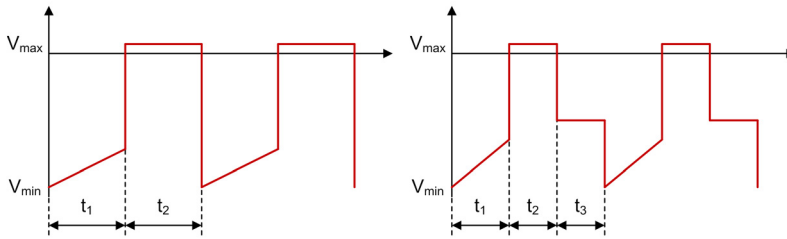

Figure 8.5.1. Zeta - Diode D_1 Voltage Waveforms in CCM and DCM

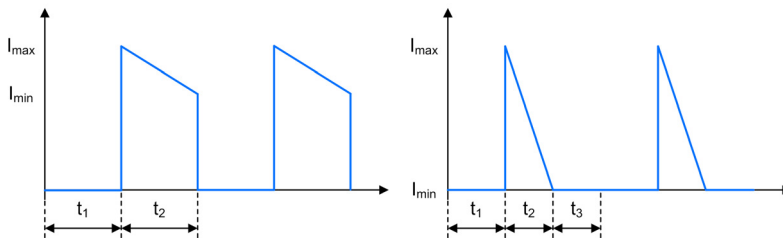

Figure 8.5.2. Zeta - Diode D_1 Current Waveforms in CCM and DCM

Min. Diode Current: $I_{D1,min} = I_{L1,min} + I_{L2,min}$

Max. Diode Current: $I_{D1,max} = I_{L1,max} + I_{L2,max}$

Average Diode Current: $I_{D1,avg} = I_{out}$

Min. Diode Voltage during t_1 : $V_{D1,min,t1} = -V_{in} - V_{out} - \frac{V_{C1,ripple}}{2}$

Max. Diode Voltage during t_1 : $V_{D1,max,t1} = -V_{in} - V_{out} + \frac{V_{C1,ripple}}{2}$

Diode Voltage during t_2 : $V_{D1,t2} = V_f$

Diode Voltage during t_3 : $V_{D1,t3} = -V_{out}$

8.6. Coupling Capacitor C_1

8.6.1. CCM & DCM.

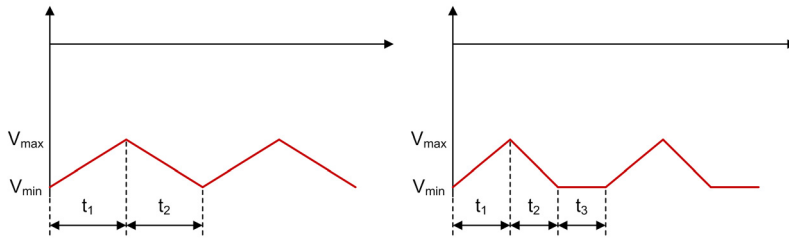

Figure 8.6.1. Zeta - Coupling Capacitor C_1 Voltage Waveforms in CCM and DCM

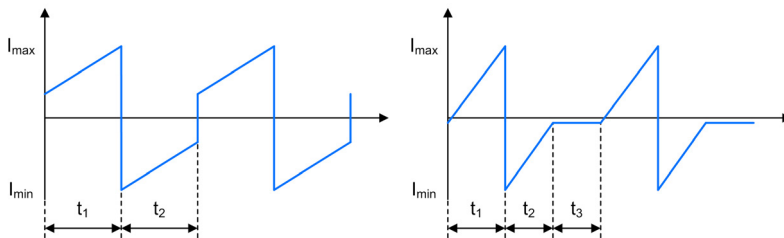

Figure 8.6.2. Zeta - Coupling Capacitor C_1 Current Waveforms in CCM and DCM

Min. Coupling Capacitor Current during t_1 : $I_{C_1,min,t_1} = -I_{L_1,min} + I_{fet,min}$

Max. Coupling Capacitor Current during t_1 : $I_{C_1,max,t_1} = -I_{L_1,max} + I_{fet,max}$

Min. Coupling Capacitor Current during t_2 : $I_{C_1,min,t_2} = -I_{L_1,max}$

Max. Coupling Capacitor Current during t_2 : $I_{C_1,max,t_2} = -I_{L_1,min}$

Coupling Capacitor Current during t_3 : $I_{C_1,t_3} = -I_{L_1,min}$

Average Coupling Capacitor Current: $I_{C_1,avg} = 0A$

Min. Coupling Capacitor Voltage: $V_{C_1,min} = -V_{out} - \frac{V_{C_1,ripple}}{2}$

Max. Coupling Capacitor Voltage: $V_{C_1,max} = -V_{out} + \frac{V_{C_1,ripple}}{2}$

Coupling Capacitor Voltage during t_3 : $V_{C_1,t_3} = -V_{out} - \frac{V_{C_1,ripple}}{2}$

8.7. Input Capacitor C_i

8.7.1. CCM & DCM.

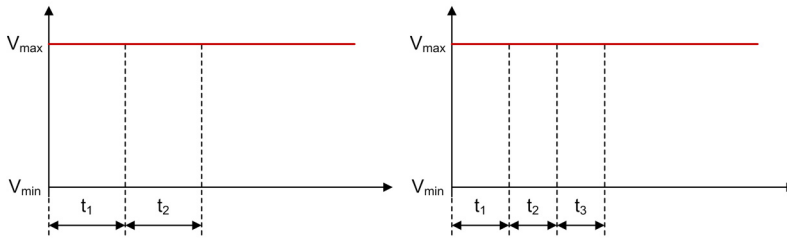

Figure 8.7.1. Zeta - Input Capacitor C_i Voltage Waveforms in CCM and DCM

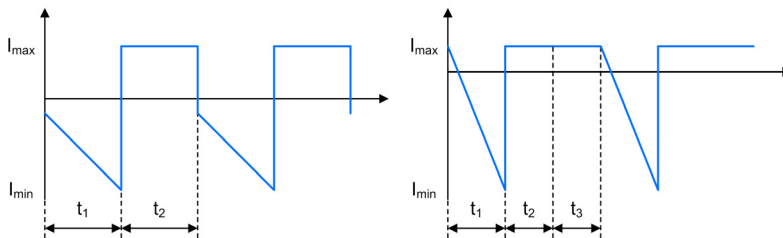

Figure 8.7.2. Zeta - Input Capacitor C_i Current Waveforms in CCM and DCM

Min. Input Capacitor Current during t_1 : $I_{C_i,min,t_1} = I_{in,avg} - I_{fet,max}$

Max. Input Capacitor Current during t_1 : $I_{C_i,max,t_1} = I_{in,avg} - I_{fet,min}$

Input Capacitor Current during t_2 and t_3 : $I_{C_i,t_2/3} = I_{in,avg}$

Average Input Capacitor Current: $I_{C_i,avg} = 0A$

Input Capacitor Voltage: $V_{C_i} = V_{in}$

8.8. Output Capacitor C_o

8.8.1. CCM & DCM.

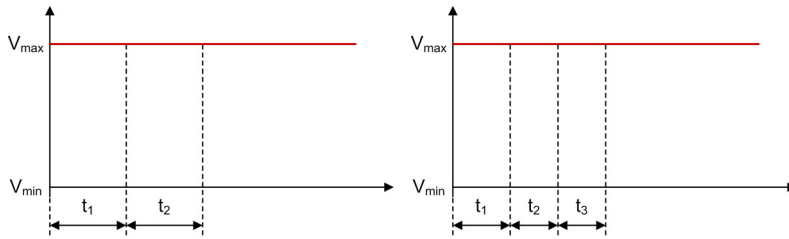

Figure 8.8.1. Zeta - Output Capacitor C_o Voltage Waveforms in CCM and DCM

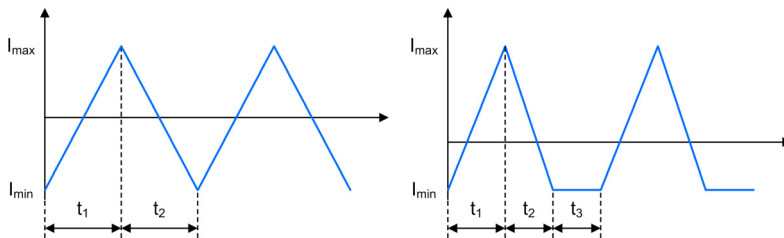

Figure 8.8.2. Zeta - Output Capacitor C_o Current Waveforms in CCM and DCM

Min. Output Capacitor Current: $I_{C_o,min} = I_{L_2,min} - I_{out}$

Max. Output Capacitor Current: $I_{C_o,max} = I_{L_2,max} - I_{out}$

Average Output Capacitor Current: $I_{C_o,avg} = 0A$

Output Capacitor Voltage: $V_{C_o} = V_{out}$

Flyback Converter

A Flyback regulator converts an input voltage to a higher or lower, positive or negative output voltage level. The energy is transferred to the output when the FET is not conducting.

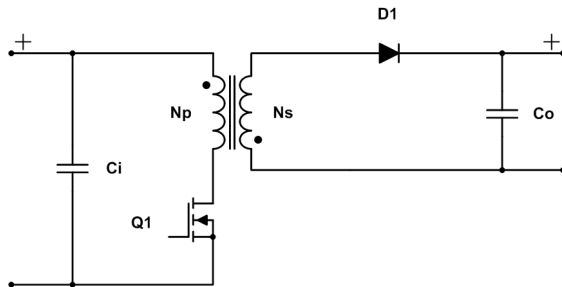

Figure 9.0.1. Schematic of a Flyback converter

9.1. General

$$\text{Secondary Inductance: } L_s = \frac{L_p}{\left(\frac{n_p}{n_s}\right)^2}$$

$$\text{Primary Current Ripple: } I_{ripple} = \frac{1}{L_p} \cdot V_{in} \cdot t_1$$

$$\text{Right Half Plane Zero: } f_{rhpz} = \frac{V_{out} \cdot (1-D)^2}{2 \cdot \pi \cdot D \cdot L_s \cdot I_{out}}$$

9.1.1. Continuous Conduction Mode.

$$\text{FET on, increasing current: } t_1 = \frac{1}{f_{switch}} \cdot (V_{out} + V_f) \cdot \frac{\frac{n_p}{n_s}}{V_{in} + (V_{out} + V_f) \cdot \frac{n_p}{n_s}}$$

$$\text{FET off, decreasing current: } t_2 = \frac{1}{f_{switch}} - t_1$$

$$\text{Min. Primary Current: } I_{pri,min} = \frac{(V_{out} + V_f) \cdot I_{out}}{V_{in} \cdot f_{switch} \cdot t_1} - \frac{1}{2} \cdot I_{ripple}$$

$$\text{Max. Primary Current: } I_{pri,max} = I_{pri,min} + I_{ripple}$$

$$\text{Min. Secondary Current: } I_{sec,min} = I_{pri,min} \cdot \frac{n_p}{n_s}$$

$$\text{Max. Secondary Current: } I_{sec,max} = (I_{pri,min} + I_{ripple}) \cdot \frac{n_p}{n_s}$$

$$\text{Average Input Current: } I_{in,avg} = \frac{(V_{out} + V_f) \cdot I_{out}}{V_{in}}$$

9.1.2. Discontinuous Conduction Mode.

$$\text{FET on, increasing current: } t_1 = \sqrt{2 \cdot I_{out} \cdot L_p \cdot \frac{V_{out} + V_f}{f_{switch} \cdot V_{in}^2}}$$

$$\text{FET off, decreasing current: } t_2 = t_1 \cdot \frac{V_{in} + (V_{out} + V_f) \cdot \frac{n_p}{n_s}}{(V_{out} + V_f) \cdot \frac{n_p}{n_s}} - t_1$$

$$\text{FET off, no current: } t_3 = \frac{1}{f_{switch}} - t_1 - t_2$$

$$\text{Min. Primary Current: } I_{pri,min} = 0A$$

$$\text{Max. Primary Current: } I_{pri,max} = I_{ripple}$$

$$\text{Min. Secondary Current: } I_{sec,min} = 0A$$

$$\text{Max. Secondary Current: } I_{sec,max} = I_{pri,max} \cdot \frac{n_p}{n_s}$$

$$\text{Average Input Current: } I_{in,avg} = \frac{(V_{out} + V_f) \cdot I_{out}}{V_{in}}$$

9.1.3. Transition Mode.

$$\text{Average Input Current: } I_{in,avg} = \frac{(V_{out} + V_f) \cdot I_{out}}{V_{in}}$$

$$\text{Switching frequency: } f_{switch,transition} = \frac{V_{in}}{2 \cdot \left(\frac{\sqrt{8} \cdot V_{in}}{\frac{n_p}{n_s} \cdot \pi \cdot V_{out}} + 1 \right)^2 \cdot I_{in} \cdot L_p}$$

$$\text{FET on, increasing current: } t_1 = \frac{2 \cdot I_{in,avg} \cdot L_p}{V_{in}} \cdot \left[\frac{\sqrt{8} \cdot V_{in}}{\frac{n_p}{n_s} \cdot \pi \cdot V_{out}} + 1 \right]$$

$$\text{FET off, decreasing current: } t_2 = \frac{1}{f_{switch,transition}} - t_1$$

$$\text{Min. Primary Current: } I_{pri,min} = 0A$$

$$\text{Max. Primary Current: } I_{pri,max} = I_{ripple}$$

$$\text{Min. Secondary Current: } I_{sec,min} = 0A$$

$$\text{Max. Secondary Current: } I_{sec,max} = I_{pri,max} \cdot \frac{n_p}{n_s}$$

9.2. Primary Side Inductor N_p

9.2.1. CCM, DCM and Transition Mode.

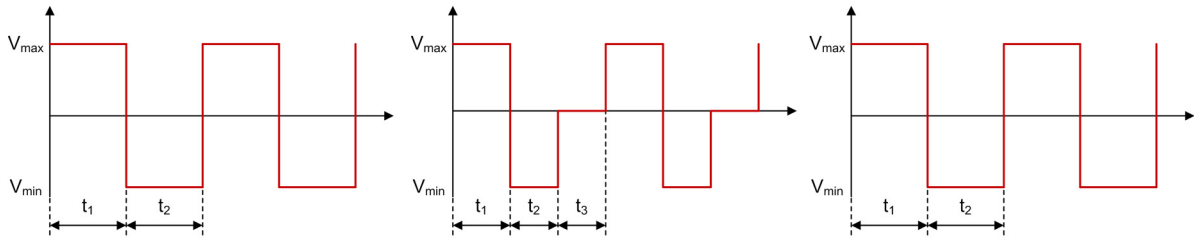

Figure 9.2.1. Flyback - Primary Side Inductor N_p Voltage Waveforms in CCM, DCM and Transition Mode

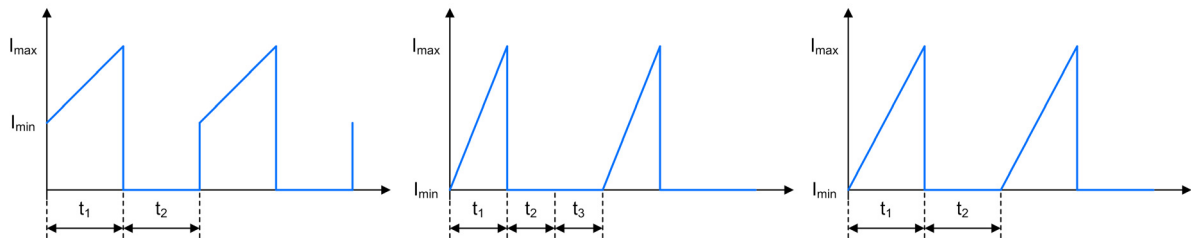

Figure 9.2.2. Flyback - Primary Side Inductor N_p Current Waveforms in CCM, DCM and Transition Mode

Average Primary Inductor Current:
$$I_{N_p,avg} = \frac{I_{pri,min} + I_{pri,max}}{2} \cdot t_1 \cdot f_{switch}$$

Min. Primary Inductor Current:
$$I_{N_p,min} = I_{pri,min}$$

Max. Primary Inductor Current:
$$I_{N_p,max} = I_{pri,max}$$

Min. Primary Inductor Voltage:
$$V_{N_p,min} = -(V_{out} + V_f) \cdot \frac{n_p}{n_s}$$

Max. Primary Inductor Voltage:
$$V_{N_p,max} = V_{in}$$

Primary Inductor Voltage during t_3 :
$$V_{N_p,t_3} = 0V$$

9.3. Secondary Side Inductor N_s

9.3.1. CCM.

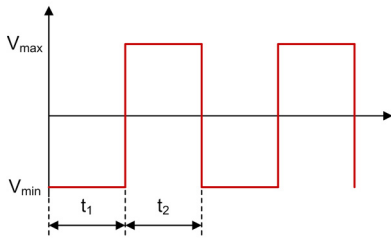

Figure 9.3.1. Flyback - Secondary Side Inductor N_s Voltage Waveform in CCM

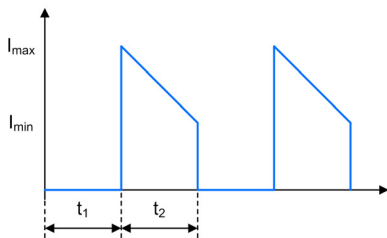

Figure 9.3.2. Flyback - Secondary Side Inductor N_s Current Waveform in CCM

Average Secondary Inductor Current:
$$I_{N_s,avg} = \frac{1}{2} \cdot (I_{sec,max} + I_{sec,min}) \cdot t_2 \cdot f_{switch}$$

Min. Secondary Inductor Current:
$$I_{N_s,min} = I_{sec,min}$$

Max. Secondary Inductor Current:
$$I_{N_s,max} = I_{sec,max}$$

Min. Secondary Inductor Voltage:
$$V_{N_s,min} = -V_{in} \cdot \frac{n_s}{n_p}$$

Max. Secondary Inductor Voltage:
$$V_{N_s,max} = V_{out} + V_f$$

9.3.2. DCM.

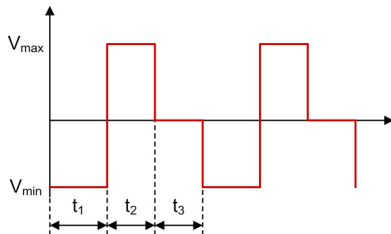
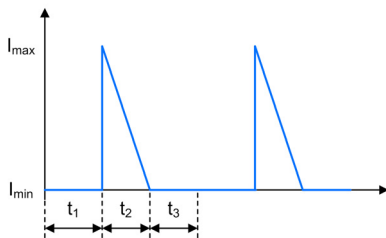
Figure 9.3.3. Flyback - Secondary Side Inductor N_s Voltage Waveform in DCMFigure 9.3.4. Flyback - Secondary Side Inductor N_s Current Waveform in DCM

Average Secondary Inductor Current: $I_{N_s,avg} = \frac{1}{2} \cdot I_{sec,max} \cdot t_2 \cdot f_{switch}$

Min. Secondary Inductor Current: $I_{N_s,min} = I_{sec,min}$

Max. Secondary Inductor Current: $I_{N_s,max} = I_{sec,max}$

Min. Secondary Inductor Voltage: $V_{N_s,min} = -V_{in} \cdot \frac{n_s}{n_p}$

Max. Secondary Inductor Voltage: $V_{N_s,max} = V_{out} + V_f$

Secondary Inductor Voltage during t_3 : $V_{N_s,t_3} = 0V$

9.3.3. Transition Mode.

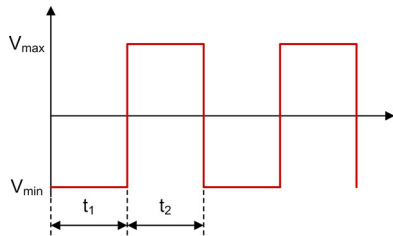

Figure 9.3.5. Flyback - Secondary Side Inductor N_s Voltage Waveform in Transition Mode

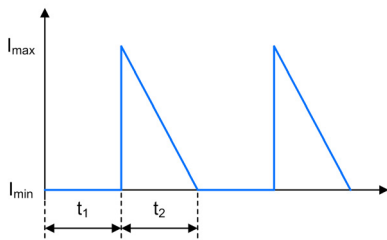

Figure 9.3.6. Flyback - Secondary Side Inductor N_s Current Waveform in Transition Mode

Average Secondary Inductor Current: $I_{N_s,avg} = \frac{1}{2} \cdot I_{sec,max} \cdot t_2 \cdot f_{switch,transiti}$

Min. Secondary Inductor Current: $I_{N_s,min} = I_{sec,min}$

Max. Secondary Inductor Current: $I_{N_s,max} = I_{sec,max}$

Min. Secondary Inductor Voltage: $V_{N_s,min} = -V_{in} \cdot \frac{n_s}{n_p}$

Max. Secondary Inductor Voltage: $V_{N_s,max} = V_{out} + V_f$

9.4. FET Q_1

9.4.1. CCM, DCM and Transition Mode.

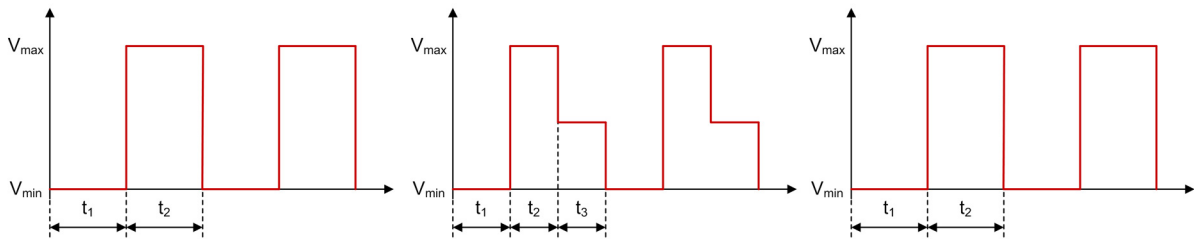

Figure 9.4.1. Flyback - FET Q_1 Voltage Waveforms in CCM, DCM and Transition Mode

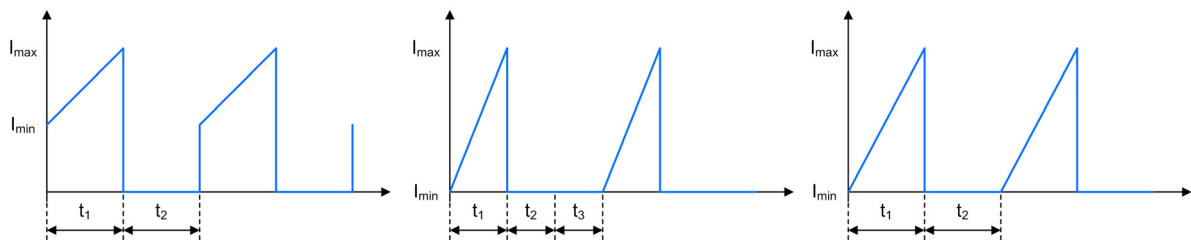

Figure 9.4.2. Flyback - FET Q_1 Current Waveforms in CCM, DCM and Transition Mode

Average FET Current: $I_{Q_1,avg} = I_{N_p,avg}$

Min. FET Current: $I_{Q_1,min} = I_{pri,min}$

Max. FET Current: $I_{Q_1,max} = I_{pri,max}$

Min. FET Voltage: $V_{Q_1,min} = 0V$

Max. FET Voltage: $V_{Q_1,max} = V_{in} + (V_{out} + V_f) \cdot \frac{n_p}{n_s}$

FET Voltage during t_3 : $V_{Q_1,t_3} = V_{in}$

9.5. Diode D_1

9.5.1. CCM, DCM and Transition Mode.

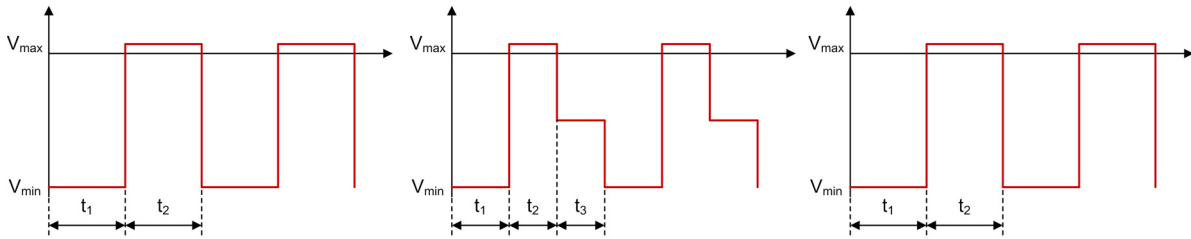

Figure 9.5.1. Flyback - Diode D_1 Voltage Waveforms in CCM, DCM and Transition Mode

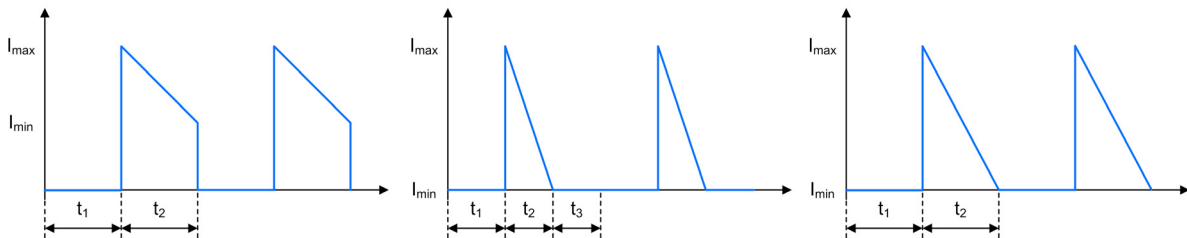

Figure 9.5.2. Flyback - Diode D_1 Current Waveforms in CCM, DCM and Transition Mode

Average Diode Current: $I_{D_1,avg} = I_{N_s,avg}$

Min. Diode Current: $I_{D_1,min} = I_{sec,min}$

Max. Diode Current: $I_{D_1,max} = I_{sec,max}$

Min. Diode Voltage: $V_{D_1,min} = -V_{out} - V_{in} \cdot \frac{n_s}{n_p}$

Max. Diode Voltage: $V_{D_1,max} = V_f$

Diode Voltage during t_3 : $V_{D_1,t_3} = -V_{out}$

9.6. Input Capacitor C_i

9.6.1. CCM.

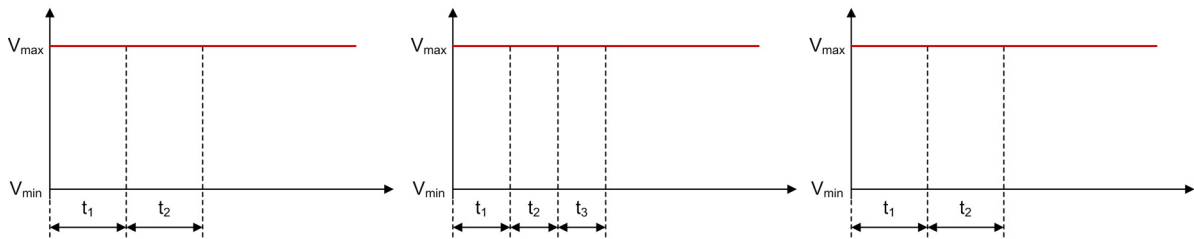

Figure 9.6.1. Flyback - Input Capacitor C_i Voltage Waveforms in CCM, DCM and Transition Mode

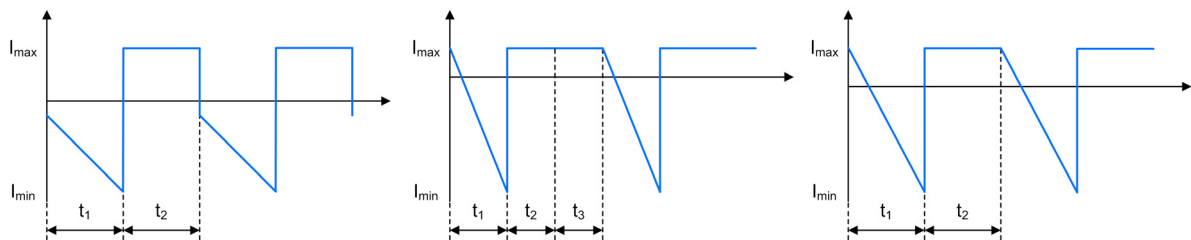

Figure 9.6.2. Flyback - Input Capacitor C_i Current Waveforms in CCM, DCM and Transition Mode

Min. Input Capacitor Current during t_1 : $I_{C_i,min,t_1} = -I_{pri,max} + I_{in,avg}$

Max. Input Capacitor Current during t_1 : $I_{C_i,max,t_1} = -I_{pri,min} + I_{in,avg}$

Input Capacitor Current during t_2 and t_3 : $I_{C_i,t_2/3} = I_{in,avg}$

Average Input Capacitor Current: $I_{C_i,avg} = 0A$

Input Capacitor Voltage: $V_{C_i} = V_{in}$

9.7. Output Capacitor C_o

9.7.1. CCM, DCM & Transition Mode.

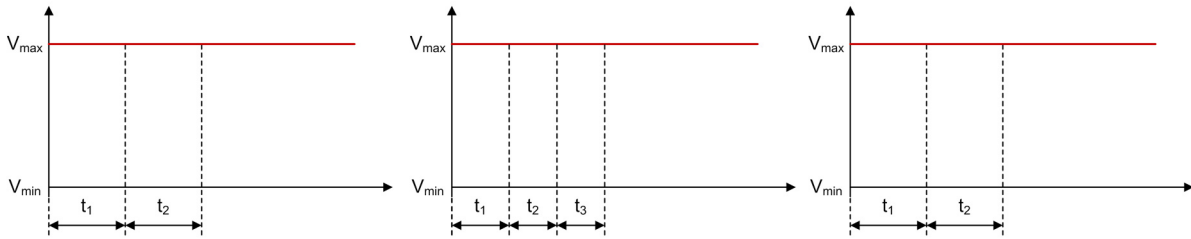

Figure 9.7.1. Flyback - Output Capacitor C_o Voltage Waveforms in CCM, DCM and Transition Mode

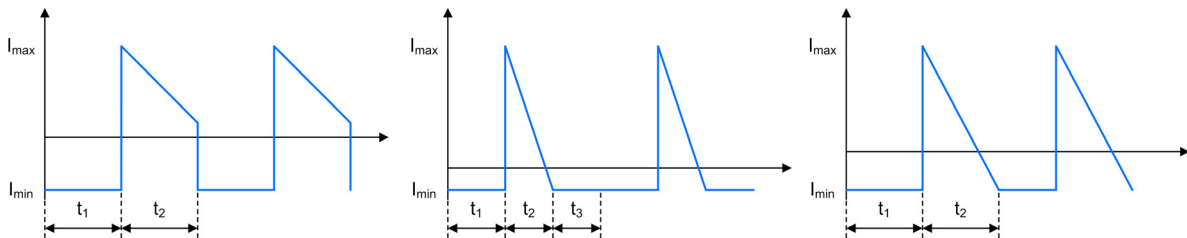

Figure 9.7.2. Flyback - Output Capacitor C_o Current Waveforms in CCM, DCM and Transition Mode

Output Capacitor Current during t_1 :

$$I_{C_o,t_1} = -I_{out}$$

Min. Output Capacitor Current during t_2 and t_3 :

$$I_{C_o,min,t_2/3} = I_{sec,min} - I_{out}$$

Max. Output Capacitor Current during t_2 and t_3 :

$$I_{C_o,max,t_2/3} = I_{sec,max} - I_{out}$$

Average Output Capacitor Current:

$$I_{C_o,avg} = 0A$$

Output Capacitor Voltage:

$$V_{C_o} = V_{out}$$

Two Switch Flyback Converter

A Two Switch Flyback regulator converts an input voltage to a higher or lower, positive or negative output voltage level. The energy is transferred to the output when the FETs are not conducting.

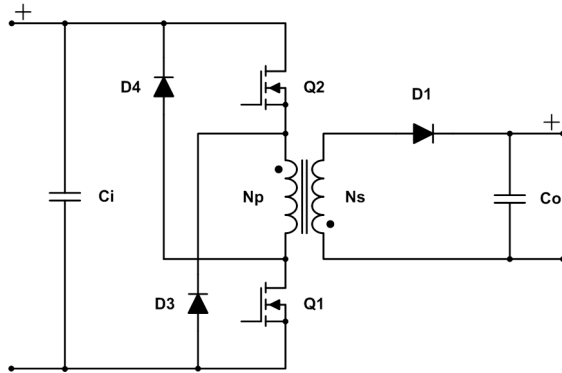

Figure 10.0.1. Schematic of a Two Switch Flyback converter

10.1. General

Secondary Inductance:
$$L_s = \frac{L_p}{\left(\frac{n_p}{n_s}\right)^2}$$

Primary Current Ripple:
$$I_{ripple} = \frac{1}{L_p} \cdot V_{in} \cdot t_1$$

Right Half Plane Zero:
$$f_{rhpz} = \frac{V_{out} \cdot (1-D)^2}{2 \cdot \pi \cdot D \cdot L_s \cdot I_{out}}$$

10.1.1. Continuous Conduction Mode.

$$\text{FETs on, increasing current: } t_1 = \frac{I}{f_{\text{switch}}} \cdot (V_{\text{out}} + V_f) \cdot \frac{\frac{n_p}{n_s}}{V_{\text{in}} + (V_{\text{out}} + V_f) \cdot \frac{n_p}{n_s}}$$

$$\text{FETs off, decreasing current: } t_2 = \frac{I}{f_{\text{switch}}} - t_1$$

$$\text{Min. Primary Current: } I_{\text{pri,min}} = \frac{(V_{\text{out}} + V_f) \cdot I_{\text{out}}}{V_{\text{in}} \cdot f_{\text{switch}} \cdot t_1} - \frac{1}{2} \cdot I_{\text{ripple}}$$

$$\text{Max. Primary Current: } I_{\text{pri,max}} = I_{\text{pri,min}} + I_{\text{ripple}}$$

$$\text{Min. Secondary Current: } I_{\text{sec,min}} = I_{\text{pri,min}} \cdot \frac{n_p}{n_s}$$

$$\text{Max. Secondary Current: } I_{\text{sec,max}} = (I_{\text{pri,min}} + I_{\text{ripple}}) \cdot \frac{n_p}{n_s}$$

$$\text{Average Input Current: } I_{\text{in,avg}} = \frac{(V_{\text{out}} + V_f) \cdot I_{\text{out}}}{V_{\text{in}}}$$

10.1.2. Discontinuous Conduction Mode.

$$\text{FETs on, increasing current: } t_1 = \sqrt{2 \cdot I_{\text{out}} \cdot L_p \cdot \frac{V_{\text{out}} + V_f}{f_{\text{switch}} \cdot V_{\text{in}}^2}}$$

$$\text{FETs off, decreasing current: } t_2 = t_1 \cdot \frac{V_{\text{in}} + (V_{\text{out}} + V_f) \cdot \frac{n_p}{n_s}}{(V_{\text{out}} + V_f) \cdot \frac{n_p}{n_s}} - t_1$$

$$\text{FETs off, no current: } t_3 = \frac{I}{f_{\text{switch}}} - t_1 - t_2$$

$$\text{Min. Primary Current: } I_{\text{pri,min}} = 0A$$

$$\text{Max. Primary Current: } I_{\text{pri,max}} = I_{\text{ripple}}$$

$$\text{Min. Secondary Current: } I_{\text{sec,min}} = 0A$$

$$\text{Max. Secondary Current: } I_{\text{sec,max}} = I_{\text{pri,max}} \cdot \frac{n_p}{n_s}$$

$$\text{Average Input Current: } I_{\text{in,avg}} = \frac{(V_{\text{out}} + V_f) \cdot I_{\text{out}}}{V_{\text{in}}}$$

10.2. Primary Side Inductor N_p

10.2.1. CCM & DCM.

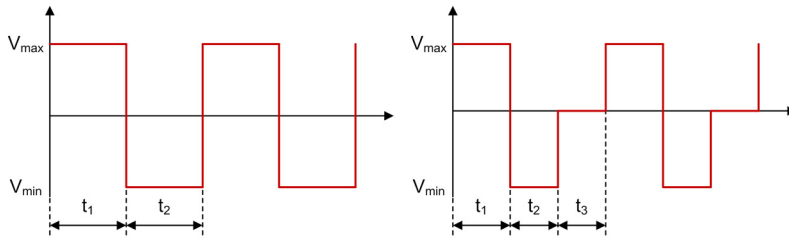

Figure 10.2.1. Two Switch Flyback - Primary Side Inductor N_p Voltage Waveforms in CCM and DCM

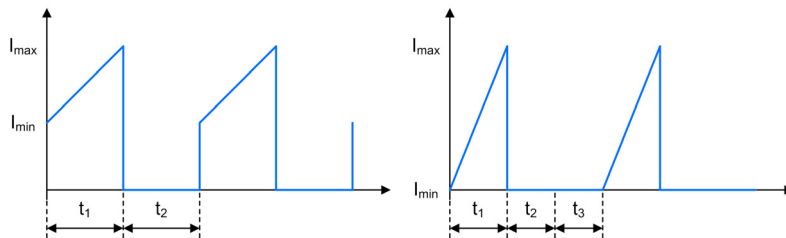

Figure 10.2.2. Two Switch Flyback - Primary Side Inductor N_p Current Waveforms in CCM and DCM

Average Primary Inductor Current:
$$I_{N_p,avg} = \frac{I_{pri,min} + I_{pri,max}}{2} \cdot t_1 \cdot f_{switch}$$

Min. Primary Inductor Current:
$$I_{N_p,min} = I_{pri,min}$$

Max. Primary Inductor Current:
$$I_{N_p,max} = I_{pri,max}$$

Min. Primary Inductor Voltage:
$$V_{N_p,min} = -(V_{out} + V_f) \cdot \frac{n_p}{n_s}$$

Max. Primary Inductor Voltage:
$$V_{N_p,max} = V_{in}$$

Primary Inductor Voltage during t_3 :
$$V_{N_p,t_3} = 0V$$

10.3. Secondary Side Inductor N_s

10.3.1. CCM & DCM.

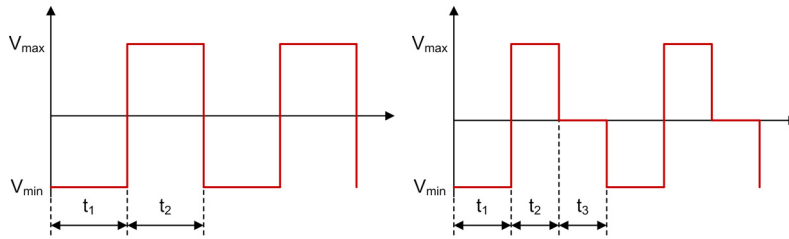

Figure 10.3.1. Two Switch Flyback - Secondary Side Inductor N_s Voltage Waveforms in CCM and DCM

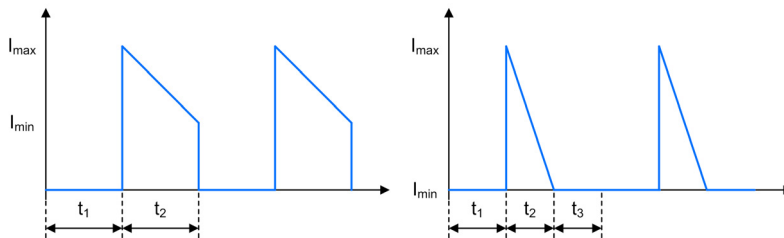

Figure 10.3.2. Two Switch Flyback - Secondary Side Inductor N_s Current Waveforms in CCM and DCM

Average Secondary Inductor Current:
$$I_{N_s,avg} = \frac{I_{sec,max} + I_{sec,min}}{2} \cdot t_2 \cdot f_{switch}$$

Min. Secondary Inductor Current:
$$I_{N_s,min} = I_{sec,min}$$

Max. Secondary Inductor Current:
$$I_{N_s,max} = I_{sec,max}$$

Min. Secondary Inductor Voltage:
$$V_{N_s,min} = -V_{in} \cdot \frac{n_s}{n_p}$$

Max. Secondary Inductor Voltage:
$$V_{N_s,max} = V_{out} + V_f$$

Secondary Inductor Voltage during t_3 :
$$V_{N_s,t_3} = 0V$$

10.4. FET Q_1 / Q_2

10.4.1. CCM & DCM.

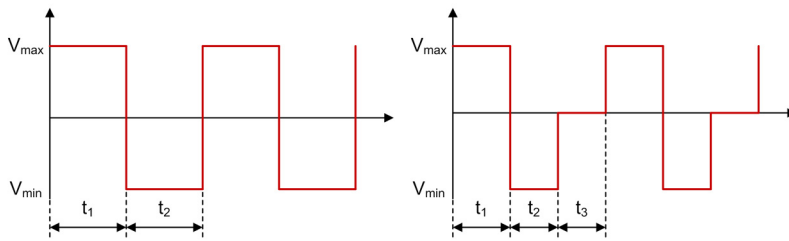

Figure 10.4.1. Two Switch Flyback - FET Q_1 / Q_2 Voltage Waveforms in CCM and DCM

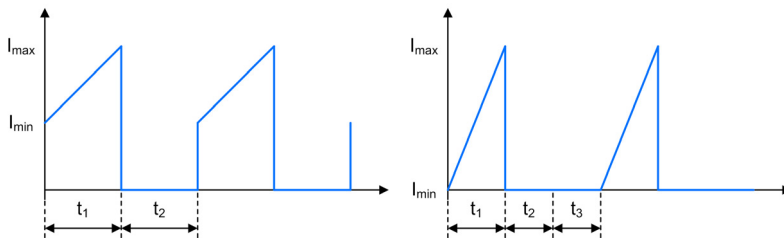

Figure 10.4.2. Two Switch Flyback - FET Q_1 / Q_2 Current Waveforms in CCM and DCM

Average FET Current: $I_{Q_{1/2},avg} = I_{in,avg}$

Min. FET Current: $I_{Q_{1/2},min} = I_{pri,min}$

Max. FET Current: $I_{Q_{1/2},max} = I_{pri,max}$

Min. FET Voltage: $V_{Q_{1/2},min} = 0V$

Max. FET Voltage: $V_{Q_{1/2},max} = \frac{V_{in} + (V_{out} + V_f) \cdot \frac{n_p}{n_s}}{2}$

FET Voltage during t_3 : $V_{Q_{1/2},t_3} = \frac{V_{in}}{2}$

10.5. Diode D_1

10.5.1. CCM & DCM.

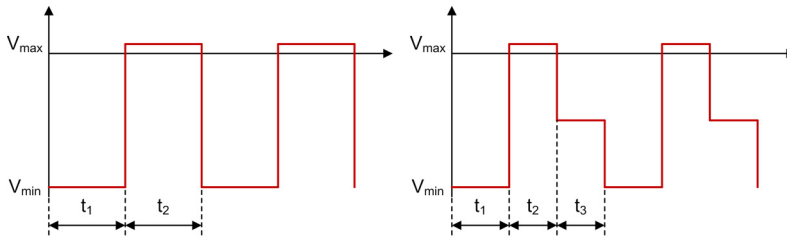

Figure 10.5.1. Two Switch Flyback - Diode D_1 Voltage Waveforms in CCM and DCM

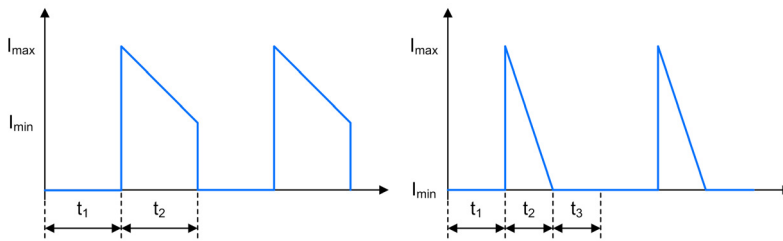

Figure 10.5.2. Two Switch Flyback - Diode D_1 Current Waveforms in CCM and DCM

Average Diode Current: $I_{D_1,avg} = I_{ind,sec,avg}$

Min. Diode Current: $I_{D_1,min} = I_{sec,min}$

Max. Diode Current: $I_{D_1,max} = I_{sec,max}$

Diode Voltage during t_1 : $V_{D_1,t_1} = -V_{out} - V_{in} \cdot \frac{n_s}{n_p}$

Diode Voltage during t_2 : $V_{D_1,t_2} = V_f$

Diode Voltage during t_3 : $V_{D_1,t_3} = -V_{out}$

10.6. Input Capacitor C_i

10.6.1. CCM & DCM.

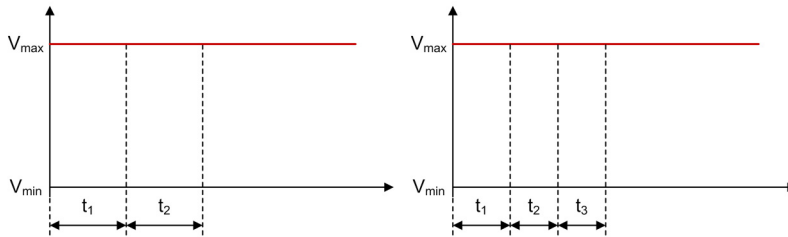

Figure 10.6.1. Two Switch Flyback - Input Capacitor C_i Voltage Waveforms in CCM and DCM

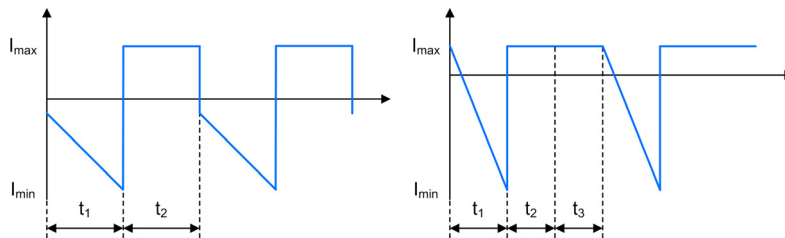

Figure 10.6.2. Two Switch Flyback - Input Capacitor C_i Current Waveforms in CCM and DCM

Min. Input Capacitor Current during t_1 : $I_{C_i,min,t_1} = -I_{pri,max} + I_{in,avg}$

Max. Input Capacitor Current during t_1 : $I_{C_i,max,t_1} = -I_{pri,min} + I_{in,avg}$

Input Capacitor Current during t_2 and t_3 : $I_{C_i,t_{2/3}} = I_{in,avg}$

Average Input Capacitor Current: $I_{C_i,avg} = 0A$

Input Capacitor Voltage: $V_{C_i} = V_{in}$

10.7. Output Capacitor C_o

10.7.1. CCM & DCM.

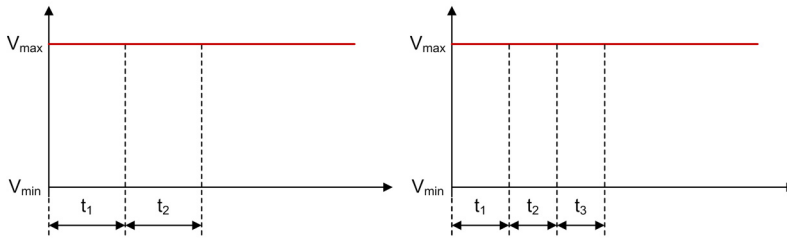

Figure 10.7.1. Two Switch Flyback - Output Capacitor C_o Voltage Waveforms in CCM and DCM

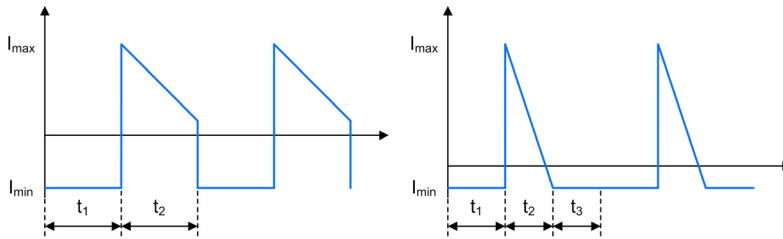

Figure 10.7.2. Two Switch Flyback - Output Capacitor C_o Current Waveforms in CCM and DCM

Output Capacitor Current during t_1 : $I_{C_o,t_1} = -I_{out}$

Min. Output Capacitor Current during t_2 and t_3 : $I_{C_o,min,t_2/3} = I_{sec,min} - I_{out}$

Max. Output Capacitor Current during t_2 and t_3 : $I_{C_o,max,t_2/3} = I_{sec,max} - I_{out}$

Average Output Capacitor Current: $I_{C_o,avg} = 0A$

Output Capacitor Voltage: $V_{C_o} = V_{out}$

Active Clamp Forward Converter

An Active Clamp Forward regulator converts an input voltage to a higher or lower, positive or negative output voltage level. The energy is transferred to the output when the FET is conducting.

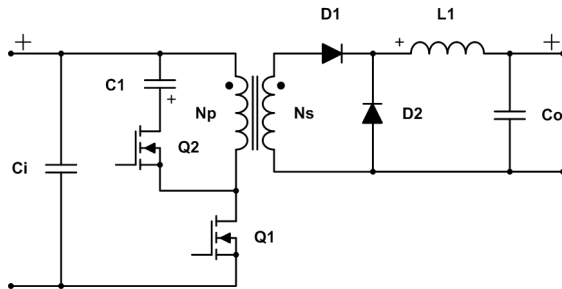

Figure 11.0.1. Schematic of an Active Clamp Forward converter

11.1. General

Secondary Side Inductance:
$$L_s = \frac{L_p}{\left(\frac{n_p}{n_s}\right)^2}$$

Inductor Current Ripple:
$$I_{ripple} = \frac{1}{L_1} \cdot \left(V_{in} \cdot \frac{n_s}{n_p} - V_f - V_{out} \right) \cdot t_1$$

11.1.1. Continuous Conduction Mode.

FET on, increasing current: $t_1 = \frac{1}{f_{switch}} \cdot \frac{V_{out} + V_f}{V_{in} \cdot \frac{n_s}{n_p}}$

FET off, decreasing current: $t_2 = \frac{1}{f_{switch}} - t_1$

Magnetization Current: $I_{mag} = \frac{V_{in} \cdot t_1}{L_p}$

Min. Secondary Current: $I_{sec,min} = I_{out} - \frac{1}{2} \cdot I_{ripple}$

Max. Secondary Current: $I_{sec,max} = I_{out} + \frac{1}{2} \cdot I_{ripple}$

Min. Primary Current: $I_{pri,min} = I_{sec,min} \cdot \frac{n_s}{n_p} - \frac{1}{2} \cdot I_{mag}$

Max. Primary Current: $I_{pri,max} = I_{sec,max} \cdot \frac{n_s}{n_p} + \frac{1}{2} \cdot I_{mag}$

Average Input Current: $I_{in,avg} = \frac{(V_{out} + V_f) \cdot I_{out}}{V_{in}}$

Clamping Voltage: $V_{clamp} = \frac{t_1 \cdot f_{switch}}{1 - t_1 \cdot f_{switch}} \cdot V_{in}$

11.1.2. Discontinuous Conduction Mode.

FET on, increasing current: $t_1 = \sqrt{2 \cdot I_{out} \cdot L_1 \cdot \frac{V_{out} + V_f}{f_{switch} \cdot (V_{in} \cdot \frac{n_s}{n_p} - V_f - V_{out}) \cdot (V_{in} \cdot \frac{n_s}{n_p})}}$

FET off, decreasing current: $t_2 = t_1 \cdot \frac{V_{in} \cdot \frac{n_s}{n_p}}{(V_{out} + V_f)} - t_1$

FET off, no current: $t_3 = \frac{1}{f_{switch}} - t_1 - t_2$

Magnetization Current: $I_{mag} = \frac{V_{in} \cdot t_1}{L_p}$

Min. Secondary Current: $I_{sec,min} = 0A$

Max. Secondary Current: $I_{sec,max} = I_{ripple}$

Min. Primary Current: $I_{pri,min} = 0A$

Max. Primary Current: $I_{pri,max} = I_{sec,max} \cdot \frac{n_s}{n_p} + \frac{1}{2} \cdot I_{mag}$

Average Input Current: $I_{in,avg} = \frac{(V_{out} + V_f) \cdot I_{out}}{V_{in}}$

Clamping Voltage: $V_{clamp} = \frac{t_1 \cdot f_{switch}}{1 - t_1 \cdot f_{switch}} \cdot V_{in}$

11.2. Primary Side Transformer Winding N_p

11.2.1. CCM & DCM.

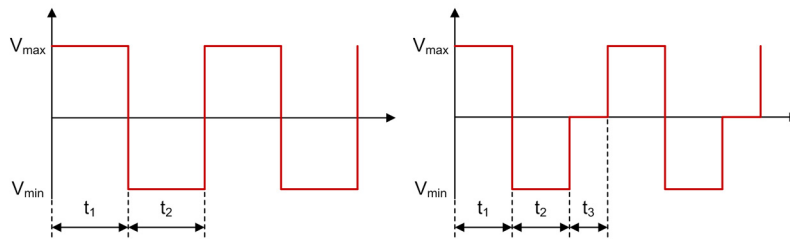

Figure 11.2.1. Active Clamp Forward - Primary Side Transformer Winding Voltage N_p Waveforms in CCM and DCM

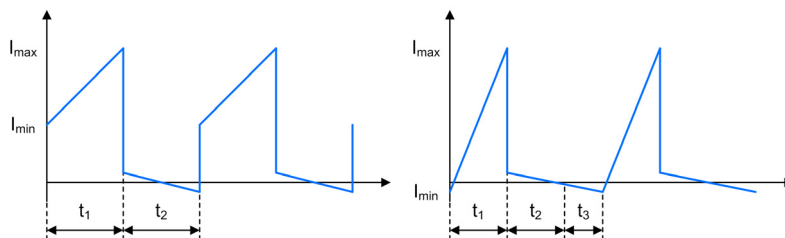

Figure 11.2.2. Active Clamp Forward - Primary Side Transformer Winding N_p Current Waveforms in CCM and DCM

Average Primary Side Transformer Current:	$I_{N_p,avg} = \frac{I_{pri,min} + I_{pri,max}}{2} \cdot t_1 \cdot f_{switch}$
Min. Primary Side Transformer Current during t_1 :	$I_{N_p,min,t_1} = I_{pri,min}$
Max. Primary Side Transformer Current during t_1 :	$I_{N_p,max,t_1} = I_{pri,max}$
Min. Primary Side Transformer Current during t_2 and t_3 :	$I_{N_p,min,t_2/3} = -\frac{1}{2} \cdot I_{mag}$
Max. Primary Side Transformer Current during t_2 and t_3 :	$I_{N_p,max,t_2/3} = \frac{1}{2} \cdot I_{mag}$
Min. Primary Side Transformer Voltage:	$V_{N_p,min} = -V_{clamp}$
Max. Primary Side Transformer Voltage:	$V_{N_p,max} = V_{in}$
Primary Side Transformer Voltage at the start of t_3 :	$V_{N_p,t_3} = 0V$

11.3. Secondary Side Transformer Winding N_s

11.3.1. CCM & DCM.

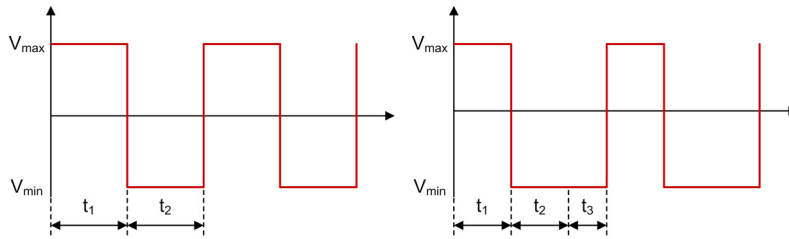

Figure 11.3.1. Active Clamp Forward - Secondary Side Transformer Winding N_s Voltage Waveforms in CCM and DCM

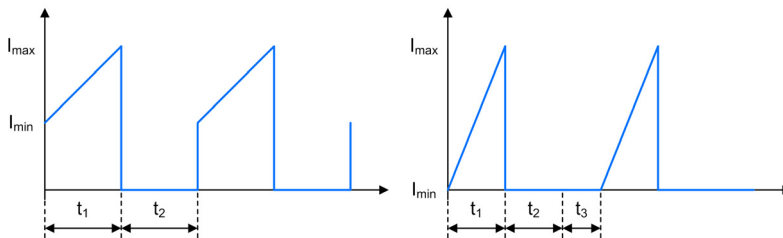

Figure 11.3.2. Active Clamp Forward - Secondary Side Transformer Winding N_s Current Waveforms in CCM and DCM

Average Secondary Side Transformer Current:
$$I_{N_s,avg} = \frac{I_{sec,min} + I_{sec,max}}{2} \cdot t_1 \cdot f_{switch}$$

Min. Secondary Side Transformer Current:
$$I_{N_s,min} = I_{sec,min}$$

Max. Secondary Side Transformer Current:
$$I_{N_s,max} = I_{sec,max}$$

Secondary Side Transformer Voltage during t_1 :
$$V_{N_s,t_1} = V_{in} \cdot \frac{n_s}{n_p}$$

Secondary Side Transformer Voltage during $t_2/3$:
$$V_{N_s,t_2/3} = -V_{clamp} \cdot \frac{n_s}{n_p}$$

11.4. Inductor L_1

11.4.1. CCM & DCM.

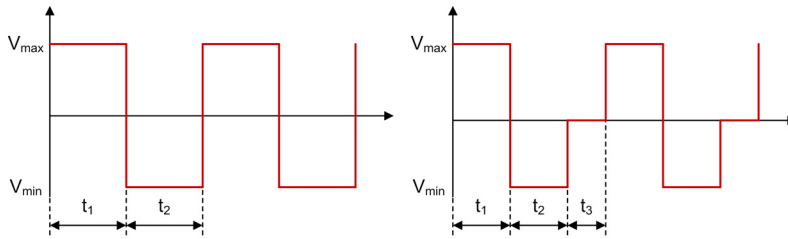

Figure 11.4.1. Active Clamp Forward - Inductor L_1 Voltage Waveforms in CCM and DCM

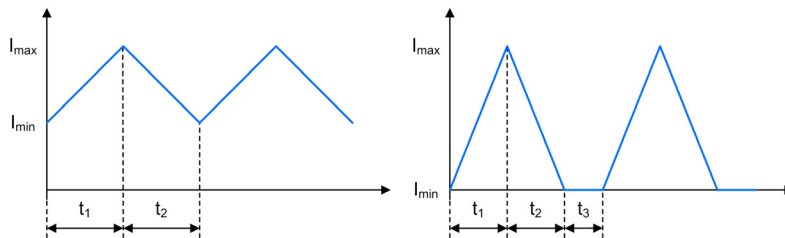

Figure 11.4.2. Active Clamp Forward - Inductor L_1 Current Waveforms in CCM and DCM

Average Inductor Current:
$$I_{L_1,avg} = \frac{I_{sec,max} + I_{sec,min}}{2} \cdot (t_1 + t_2) \cdot f_{switch}$$

Min. Inductor Current:
$$I_{L_1,min} = I_{trans,sec,min}$$

Max. Inductor Current:
$$I_{L_1,max} = I_{trans,sec,max}$$

Min. Inductor Voltage:
$$V_{L_1,min} = -V_{out} - V_f$$

Max. Inductor Voltage:
$$V_{L_1,max} = V_{in} \cdot \frac{n_s}{n_p} - V_{out} - V_f$$

Inductor Voltage during t_3 :
$$V_{L_1,t_3} = 0V$$

11.5. FET Q_1

11.5.1. CCM & DCM.

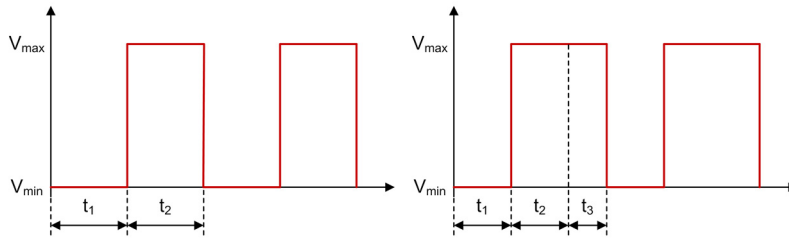

Figure 11.5.1. Active Clamp Forward - FET Q_1 Voltage Waveforms in CCM and DCM

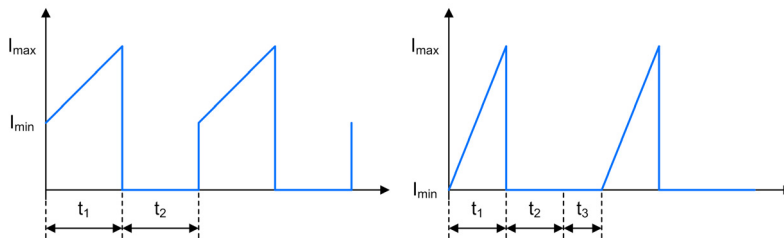

Figure 11.5.2. Active Clamp Forward - FET Q_1 Current Waveforms in CCM and DCM

Average FET Current: $I_{Q_1,avg} = I_{N_p,avg}$

Min. FET Current: $I_{Q_1,min} = I_{pri,min}$

Max. FET Current: $I_{Q_1,max} = I_{pri,max}$

Min. FET Voltage: $V_{Q_1,min} = 0V$

Max. FET Voltage: $V_{Q_1,max} = \frac{V_{in}}{1-D}$

FET Voltage during t_3 : $V_{Q_1,t_3} = \frac{V_{in}}{1-D}$

11.6. Clamping FET Q_2

11.6.1. CCM & DCM.

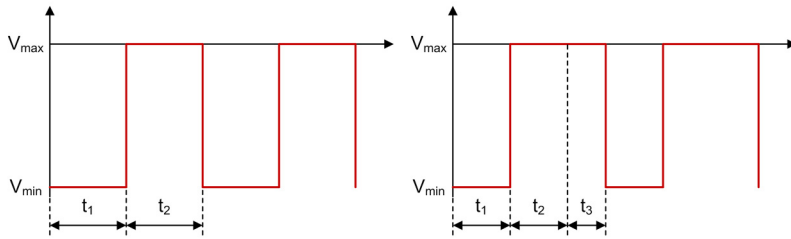

Figure 11.6.1. Active Clamp Forward - Clamping FET Q_2 Voltage Waveforms in CCM and DCM

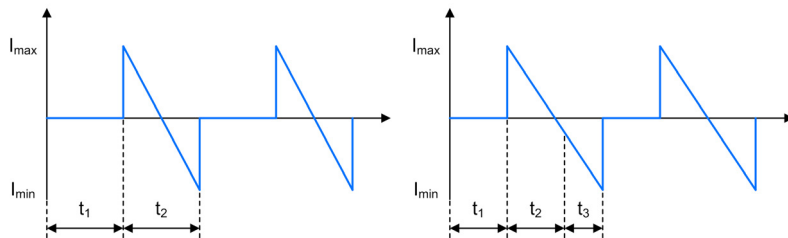

Figure 11.6.2. Active Clamp Forward - Clamping FET Q_2 Current Waveforms in CCM and DCM

Average Clamping FET Current: $I_{Q_2,avg} = 0A$

Clamping FET Current during t_1 : $I_{Q_2,t_1} = 0A$

Min. Clamping FET Current during $t_{2/3}$: $I_{Q_2,min} = -\frac{1}{2} \cdot I_{mag}$

Max. Clamping FET Current during $t_{2/3}$: $I_{Q_2,max} = \frac{1}{2} \cdot I_{mag}$

Min. Clamping FET Voltage: $V_{Q_2,min} = -V_{in} - V_{clamp}$

Max. Clamping FET Voltage: $V_{Q_2,max} = 0V$

Clamping FET Voltage during t_3 : $V_{Q_2,t_3} = 0V$

11.7. Clamping Capacitor C_1

11.7.1. CCM & DCM.

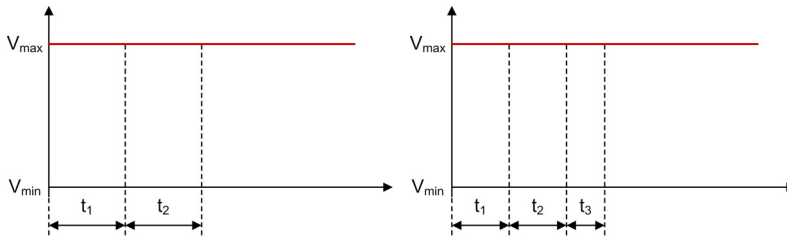

Figure 11.7.1. Active Clamp Forward - Clamping Capacitor C_1 Voltage Waveforms in CCM and DCM

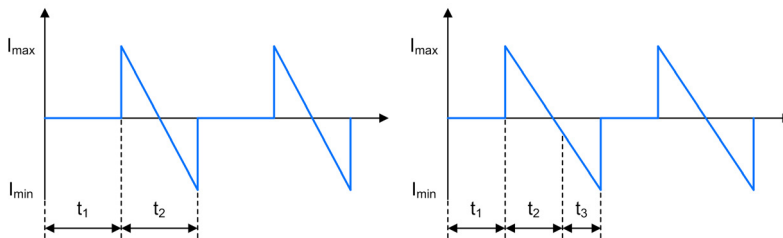

Figure 11.7.2. Active Clamp Forward - Clamping Capacitor C_1 Current Waveforms in CCM and DCM

Average Clamping Capacitor Current: $I_{C_1,avg} = 0A$

Clamping Capacitor Current during t_1 : $I_{C_1,t_1} = 0A$

Min. Clamping Capacitor Current during $t_{2/3}$: $I_{C_1,min} = I_{Q_2,min}$

Max. Clamping Capacitor Current during $t_{2/3}$: $I_{C_1,max} = I_{Q_2,max}$

Clamping Capacitor Voltage: $V_{C_1} = V_{clamp}$

11.8. Rectifier Diode D_1

11.8.1. CCM & DCM.

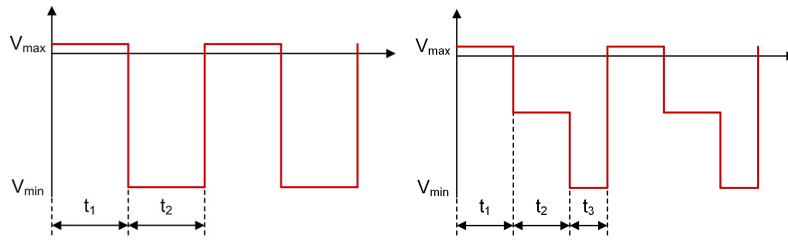

Figure 11.8.1. Active Clamp Forward - Rectifier Diode D_1 Voltage Waveforms in CCM and DCM

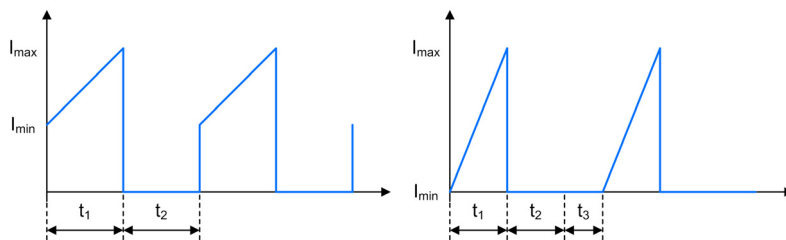

Figure 11.8.2. Active Clamp Forward - Rectifier Diode D_1 Current Waveforms in CCM and DCM

Average Rectifier Diode Current:
$$I_{D_1,avg} = \frac{I_{N_s,min} + I_{N_s,max}}{2} \cdot t_2 \cdot f_{switch}$$

Min. Rectifier Diode Current:
$$I_{D_1,min} = I_{trans,sec,min}$$

Max. Rectifier Diode Current:
$$I_{D_1,max} = I_{trans,sec,max}$$

Min. Rectifier Diode Voltage:
$$V_{D_1,min} = -V_{clamp} \cdot \frac{n_s}{n_p} + V_f$$

Max. Rectifier Diode Voltage:
$$V_{D_1,max} = V_f$$

Rectifier Diode Voltage during t_3 :
$$V_{D_1,t_3} = -V_{clamp} \cdot \frac{n_s}{n_p} - V_{out}$$

11.9. Freewheeling Diode D_2

11.9.1. CCM & DCM.

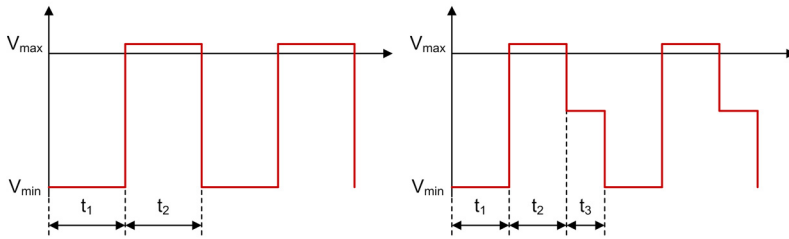

Figure 11.9.1. Active Clamp Forward - Freewheeling Diode D_2 Voltage Waveforms in CCM and DCM

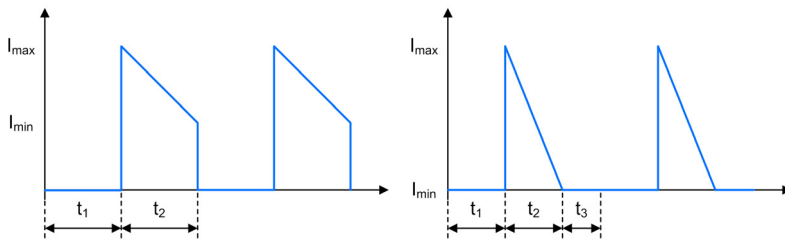

Figure 11.9.2. Active Clamp Forward - Freewheeling Diode D_2 Current Waveforms in CCM and DCM

Average Freewheeling Diode Current: $I_{D_2,avg} = I_{N_s,avg}$

Min. Freewheeling Diode Current: $I_{D_2,min} = I_{N_s,min}$

Max. Freewheeling Diode Current: $I_{D_2,max} = I_{N_s,max}$

Min. Freewheeling Diode Voltage: $V_{D_2,min} = -V_{in} \cdot \frac{n_s}{n_p} + V_f$

Max. Freewheeling Diode Voltage: $V_{D_2,max} = V_f$

Freewheeling Diode Voltage during t_3 : $V_{D_2,t_3} = -V_{out}$

11.10. Input Capacitor C_i

11.10.1. CCM & DCM.

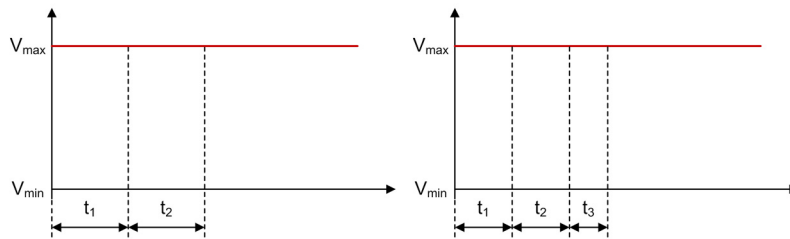

Figure 11.10.1. Active Clamp Forward - Input Capacitor C_i Voltage Waveforms in CCM and DCM

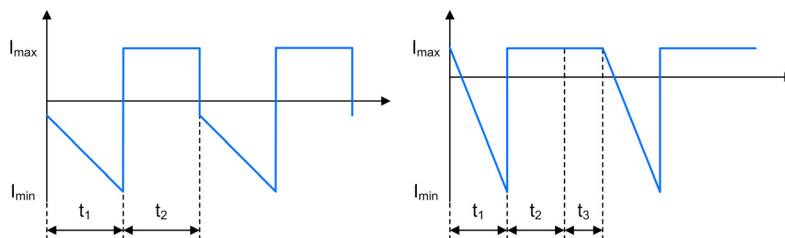

Figure 11.10.2. Active Clamp Forward - Input Capacitor C_i Current Waveforms in CCM and DCM

Min. Input Capacitor Current during t_1 : $I_{C_i,min,t_1} = I_{N_p,avg} - I_{trans,pri,max}$

Max. Input Capacitor Current during t_1 : $I_{C_i,max,t_1} = I_{N_p,avg} - I_{trans,pri,min}$

Input Capacitor Current during t_2 and t_3 : $I_{C_i,t_{2/3}} = I_{N_p,avg}$

Average Input Capacitor Current: $I_{C_i,avg} = 0A$

Input Capacitor Voltage: $V_{C_i} = V_{in}$

11.11. Output Capacitor C_o

11.11.1. CCM & DCM.

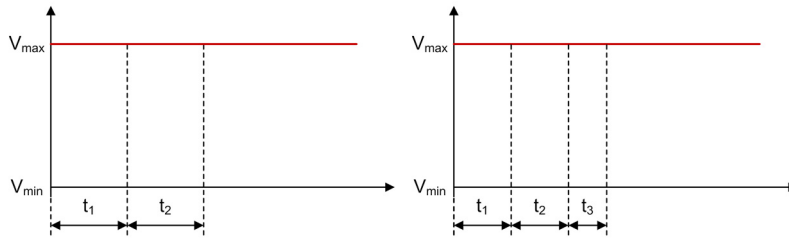

Figure 11.11.1. Active Clamp Forward - Output Capacitor C_o Voltage Waveforms in CCM and DCM

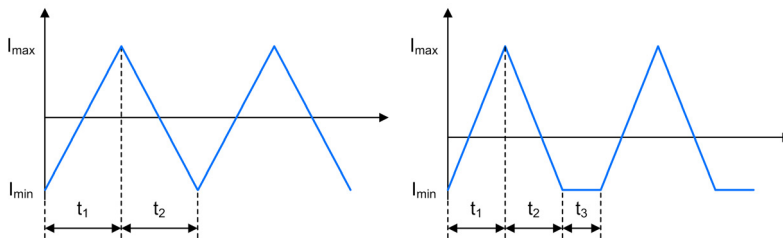

Figure 11.11.2. Active Clamp Forward - Output Capacitor C_o Current Waveforms in CCM and DCM

Min. Output Capacitor Current: $I_{C_o,min} = I_{L1,min} - I_{out}$

Max. Output Capacitor Current: $I_{C_o,max} = I_{L1,max} - I_{out}$

Output Capacitor Current during t_3 : $I_{C_o,t3} = I_{L1,min} - I_{out}$

Average Output Capacitor Current: $I_{C_o,avg} = 0A$

Output Capacitor Voltage: $V_{C_o} = V_{out}$

Single Switch Forward Converter

A Single Switch Forward regulator converts an input voltage to a higher or lower, positive or negative output voltage level. The energy is transferred to the output when the FET is conducting. The turns ratio between N_p and N_s is assumed to be 1:1.

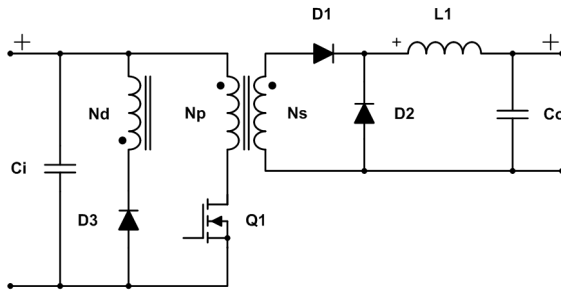

Figure 12.0.1. Schematic of a Single Switch Forward converter

12.1. General

Secondary Side Inductance:
$$L_s = \frac{L_p}{\left(\frac{n_p}{n_s}\right)^2}$$

Inductor Current Ripple:
$$I_{ripple} = \frac{1}{L_1} \cdot \left(V_{in} \cdot \frac{n_s}{n_p} - V_f - V_{out} \right) \cdot t_1$$

12.1.1. Continuous Conduction Mode.

$$\begin{aligned} \text{FET on, increasing current:} \quad t_1 &= \frac{1}{f_{switch}} \cdot \frac{V_{out} + V_f}{V_{in} \cdot \frac{n_s}{n_p}} \\ \text{Demagnetization Time:} \quad t_d &= t_1 \\ \text{FET off, decreasing current:} \quad t_2 &= \frac{1}{f_{switch}} - t_1 \\ \text{Magnetization Current:} \quad I_{mag} &= \frac{V_{in} \cdot t_1}{L_p} \\ \text{Min. Secondary Current:} \quad I_{sec,min} &= I_{out} - \frac{1}{2} \cdot I_{ripple} \\ \text{Max. Secondary Current:} \quad I_{sec,max} &= I_{out} + \frac{1}{2} \cdot I_{ripple} \\ \text{Min. Primary Current:} \quad I_{pri,min} &= I_{sec,min} \cdot \frac{n_s}{n_p} \\ \text{Max. Primary Current:} \quad I_{pri,max} &= I_{sec,max} \cdot \frac{n_s}{n_p} + I_{mag} \\ \text{Average Input Current:} \quad I_{in,avg} &= \frac{(V_{out} + V_f) \cdot I_{out}}{V_{in}} \end{aligned}$$

12.1.2. Discontinuous Conduction Mode.

$$\begin{aligned} \text{FET on, increasing current:} \quad t_1 &= \sqrt{2 \cdot I_{out} \cdot L_1 \cdot \frac{V_{out} + V_f}{f_{switch} \cdot (V_{in} \cdot \frac{n_s}{n_p} - V_f - V_{out}) \cdot (V_{in} \cdot \frac{n_s}{n_p})}} \\ \text{Demagnetization Time:} \quad t_d &= t_1 \\ \text{FET off, decreasing current:} \quad t_2 &= t_1 \cdot \frac{V_{in} \cdot \frac{n_s}{n_p}}{(V_{out} + V_f)} - t_1 \\ \text{FET off, no current (if } t_2 > t_d\text{):} \quad t_3 &= \frac{1}{f_{switch}} - t_1 - t_2 \\ \text{FET off, no current (if } t_d \geq t_2\text{):} \quad t_3 &= \frac{1}{f_{switch}} - t_1 - t_d \\ \text{Min. Secondary Current:} \quad I_{sec,min} &= 0A \\ \text{Max. Secondary Current:} \quad I_{sec,max} &= I_{ripple} \\ \text{Min. Primary Current:} \quad I_{pri,min} &= 0A \\ \text{Max. Primary Current:} \quad I_{pri,max} &= I_{sec,max} \cdot \frac{n_s}{n_p} + I_{mag} \\ \text{Average Input Current:} \quad I_{in,avg} &= \frac{(V_{out} + V_f) \cdot I_{out}}{V_{in}} \end{aligned}$$

12.2. Primary Side Transformer Winding N_p

12.2.1. CCM & DCM.

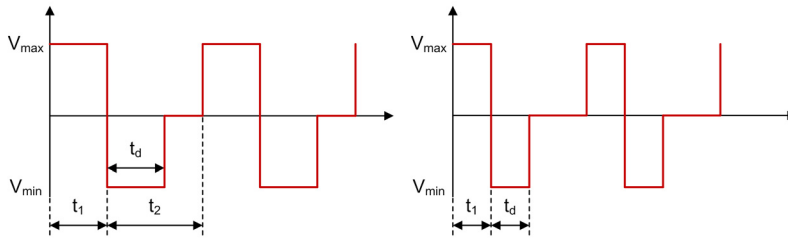

Figure 12.2.1. Single Switch Forward - Primary Side Transformer Winding N_p Voltage Waveforms in CCM and DCM

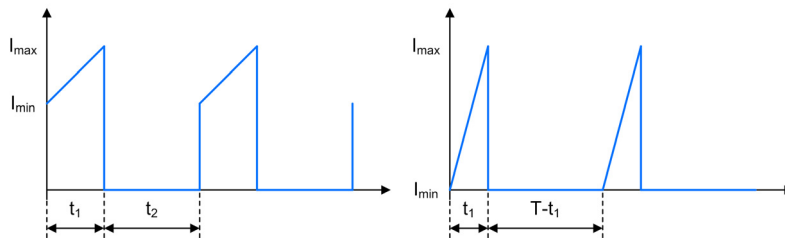

Figure 12.2.2. Single Switch Forward - Primary Side Transformer Winding N_p Current Waveforms in CCM and DCM

Average Primary Transformer Current:
$$I_{N_p,avg} = \left(\frac{I_{pri,min} + I_{pri,max}}{2} \cdot t_1 \right) \cdot f_{switch}$$

Min. Primary Transformer Current:
$$I_{N_p,min} = I_{pri,min}$$

Max. Primary Transformer Current:
$$I_{N_p,max} = I_{pri,max}$$

Min. Primary Transformer Voltage:
$$V_{N_p,min} = -V_{in}$$

Max. Primary Transformer Voltage:
$$V_{N_p,max} = V_{in}$$

Primary Transformer Voltage after t_d :
$$V_{N_p,t_d} = 0V$$

Primary Transformer Voltage during t_3 :
$$V_{N_p,t_3} = 0V$$

12.3. Secondary Side Transformer Winding N_s

12.3.1. CCM & DCM.

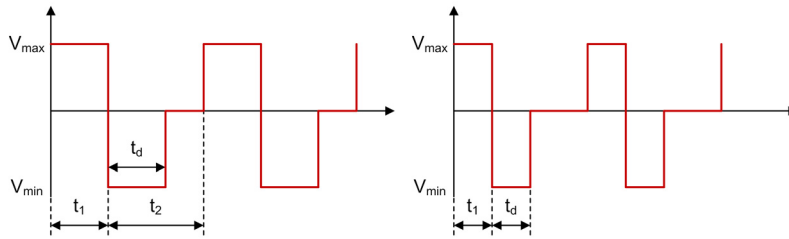

Figure 12.3.1. Single Switch Forward - Secondary Side Transformer Winding N_s Voltage Waveforms in CCM and DCM

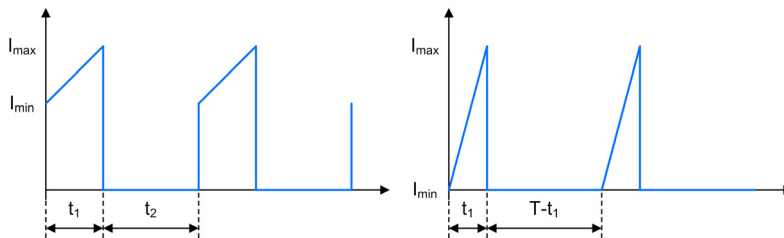

Figure 12.3.2. Single Switch Forward - Secondary Side Transformer Winding N_s Current Waveforms in CCM and DCM

Average Secondary Transformer Current:
$$I_{N_s,avg} = \frac{I_{sec,min} + I_{sec,max}}{2} \cdot t_1 \cdot f_{switch}$$

Min. Secondary Transformer Current:
$$I_{N_s,min} = I_{sec,min}$$

Max. Secondary Transformer Current:
$$I_{N_s,max} = I_{sec,max}$$

Min. Secondary Transformer Voltage:
$$V_{N_s,min} = -(V_{in} + V_f) \cdot \frac{n_s}{n_p}$$

Max. Secondary Transformer Voltage:
$$V_{N_s,max} = V_{in} \cdot \frac{n_s}{n_p}$$

Secondary Transformer Voltage after t_d :
$$V_{N_s,t_{od}} = 0V$$

Secondary Transformer Voltage during t_3 :
$$V_{N_s,t_3} = 0V$$

12.4. Inductor L_1

12.4.1. CCM & DCM.

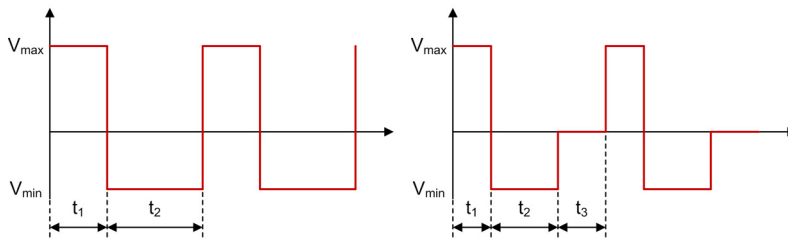

Figure 12.4.1. Single Switch Forward - Inductor L_1 Voltage Waveforms in CCM and DCM

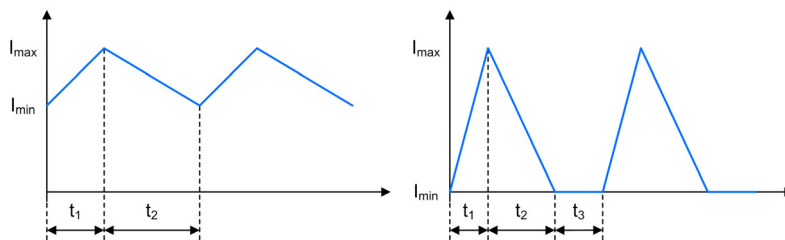

Figure 12.4.2. Single Switch Forward - Inductor L_1 Current Waveforms in CCM and DCM

Average Inductor Current:
$$I_{L_1,avg} = \frac{I_{sec,max} + I_{sec,min}}{2} \cdot (t_1 + t_2) \cdot f_{switch}$$

Min. Inductor Current:
$$I_{L_1,min} = I_{sec,min}$$

Max. Inductor Current:
$$I_{L_1,max} = I_{sec,max}$$

Min. Inductor Voltage:
$$V_{L_1,min} = -V_{out} - V_f$$

Max. Inductor Voltage:
$$V_{L_1,max} = V_{in} \cdot \frac{n_s}{n_p} - V_{out} - V_f$$

Inductor Voltage during t_3 :
$$V_{L_1,t_3} = 0V$$

12.5. FET Q_1

12.5.1. CCM & DCM.

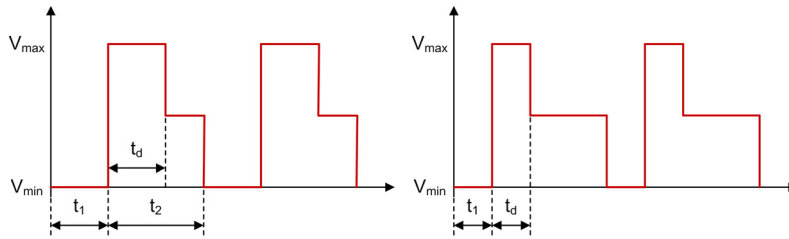

Figure 12.5.1. Single Switch Forward - FET Q_1 Voltage Waveforms in CCM and DCM

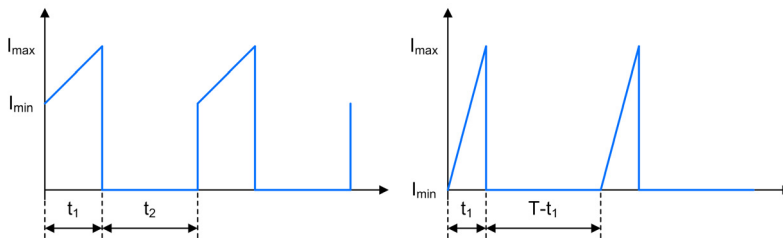

Figure 12.5.2. Single Switch Forward - FET Q_1 Current Waveforms in CCM and DCM

Average FET Current: $I_{Q_1,avg} = I_{N_p,avg}$

Min. FET Current: $I_{Q_1,min} = I_{pri,min}$

Max. FET Current: $I_{Q_1,max} = I_{pri,max}$

Min. FET Voltage: $V_{Q_1,min} = 0V$

Max. FET Voltage: $V_{Q_1,max} = 2 \cdot V_{in} + V_f$

FET Voltage after t_d : $V_{Q_1,t_{ad}} = V_{in}$

FET Voltage during t_3 : $V_{Q_1,t_3} = V_{in}$

12.6. Demagnetization Winding N_d

12.6.1. CCM & DCM.

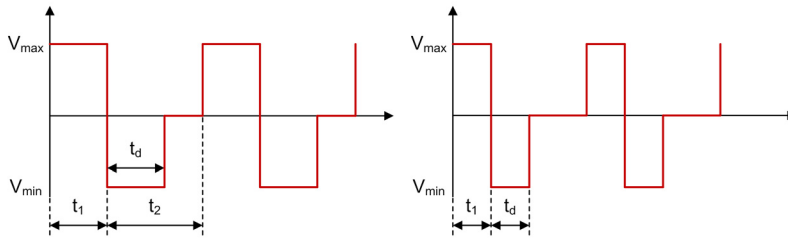

Figure 12.6.1. Single Switch Forward - Demagnetization Winding N_d Voltage Waveforms in CCM and DCM

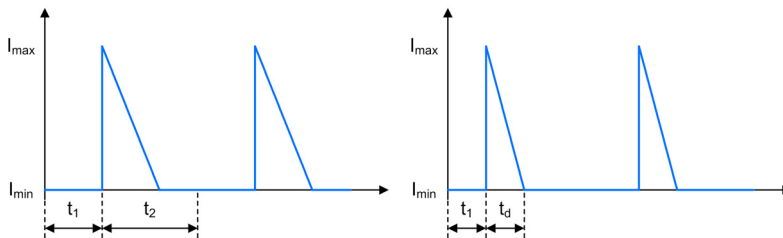

Figure 12.6.2. Single Switch Forward - Demagnetization Winding N_d Current Waveforms in CCM and DCM

Average Demagnetization Winding Current: $I_{N_d,avg} = \frac{I_{mag}}{2} \cdot t_d \cdot f_{switch}$

Min. Demagnetization Winding Current: $I_{N_d,min} = 0A$

Max. Demagnetization Winding Current: $I_{N_d,max} = I_{mag}$

Min. Demagnetization Winding Voltage: $V_{N_d,min} = -V_{in}$

Max. Demagnetization Winding Voltage: $V_{N_d,max} = V_{in}$

Demagnetization Winding Voltage after t_d : $V_{N_d,t_d} = 0V$

Demagnetization Winding Voltage during t_3 : $V_{N_d,t_3} = 0V$

12.7. Demagnetization Diode D_3

12.7.1. CCM & DCM.

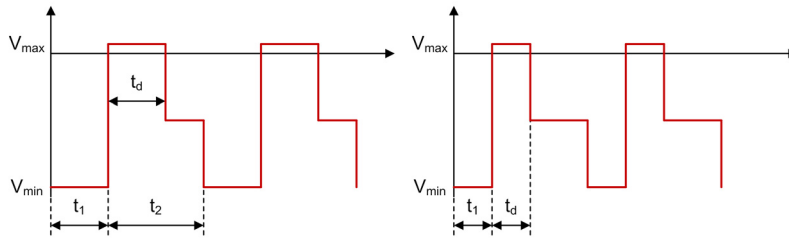

Figure 12.7.1. Single Switch Forward - Demagnetization Diode D_3 Voltage Waveforms in CCM and DCM

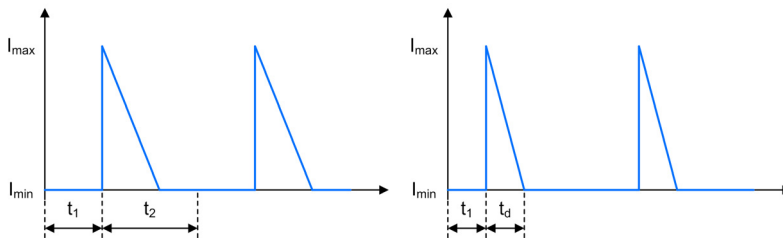

Figure 12.7.2. Single Switch Forward - Demagnetization Diode D_3 Current Waveforms in CCM and DCM

Average Demagnetization Diode Current: $I_{D_3,avg} = \frac{I_{mag}}{2} \cdot t_d \cdot f_{switch}$

Min. Demagnetization Diode Current: $I_{D_3,min} = 0A$

Max. Demagnetization Diode Current: $I_{D_3,max} = I_{mag}$

Min. Demagnetization Diode Voltage: $V_{D_3,min} = -2 \cdot V_{in}$

Max. Demagnetization Diode Voltage: $V_{D_3,max} = V_f$

Demagnetization Diode Voltage after t_d : $V_{D_3,t_{ad}} = -V_{in}$

Demagnetization Diode Voltage during t_3 : $V_{D_3,t_3} = -V_{in}$

12.8. Rectifier Diode D_1

12.8.1. CCM & DCM.

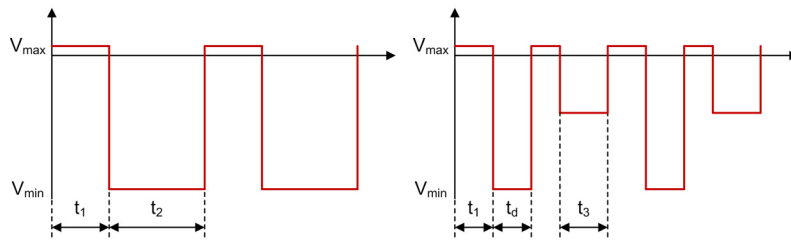

Figure 12.8.1. Single Switch Forward - Rectifier Diode D_1 Voltage Waveforms in CCM and DCM

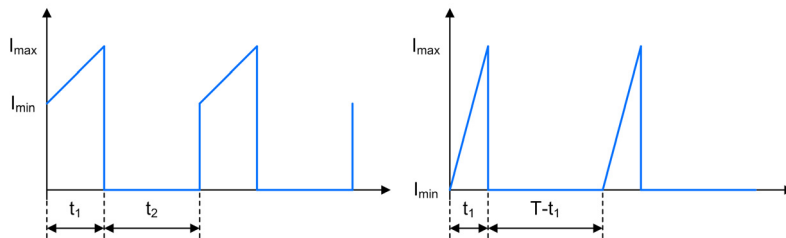

Figure 12.8.2. Single Switch Forward - Rectifier Diode D_1 Current Waveforms in CCM and DCM

Average Rectifier Diode Current:
$$I_{D1,avg} = \frac{I_{sec,min} + I_{sec,max}}{2} \cdot t_2 \cdot f_{switch}$$

Min. Rectifier Diode Current:
$$I_{D1,min} = I_{trans,sec,min}$$

Max. Rectifier Diode Current:
$$I_{D1,max} = I_{trans,sec,max}$$

Min. Rectifier Diode Voltage :
$$V_{D1,min} = -(V_{in} + V_f) \cdot \frac{n_s}{n_p} + V_f$$

Max. Rectifier Diode Voltage:
$$V_{D1,max} = V_f$$

Rectifier Diode Voltage after t_d :
$$V_{D1,t_d} = V_f$$

Rectifier Diode Voltage during t_3 :
$$V_{D1,t_3} = -V_{out}$$

12.9. Freewheeling Diode D_2

12.8.1. CCM & DCM.

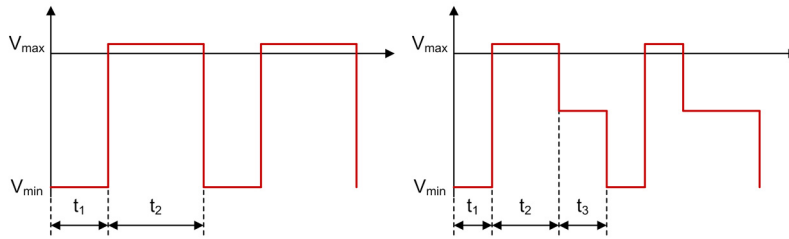

Figure 12.9.1. Single Switch Forward - Freewheeling Diode D_2 Voltage Waveforms in CCM and DCM

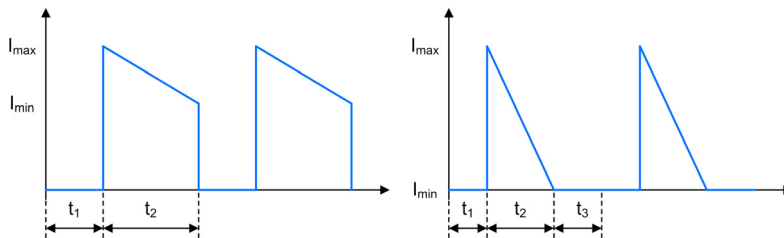

Figure 12.9.2. Single Switch Forward - Freewheeling Diode D_2 Current Waveforms in CCM and DCM

Average Freewheeling Diode Current: $I_{D_2,avg} = I_{N_s,avg}$

Min. Freewheeling Diode Current: $I_{D_2,min} = I_{sec,min}$

Max. Freewheeling Diode Current: $I_{D_2,max} = I_{sec,max}$

Min. Freewheeling Diode Voltage: $V_{D_2,min} = -V_{in} \cdot \frac{n_s}{n_p} + V_f$

Max. Freewheeling Diode Voltage: $V_{D_2,max} = V_f$

Freewheeling Diode Voltage during t_3 : $V_{D_2,t_3} = -V_{out}$

12.10. Input Capacitor C_i

12.10.1. CCM & DCM.

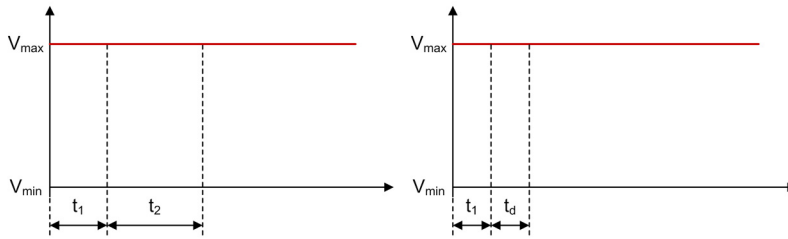

Figure 12.10.1. Single Switch Forward - Input Capacitor C_i Voltage Waveforms in CCM and DCM

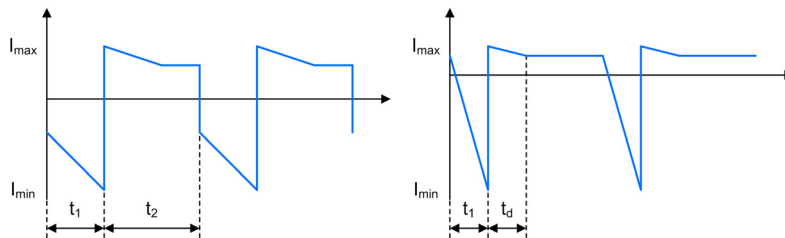

Figure 12.10.2. Single Switch Forward - Input Capacitor C_i Current Waveforms in CCM and DCM

Min. Input Capacitor Current during t_1 : $I_{C_i,min,t_1} = I_{N_p,avg} - I_{pri,max} - I_{D_3,avg}$

Max. Input Capacitor Current during t_1 : $I_{C_i,max,t_1} = I_{N_p,avg} - I_{pri,min} - I_{D_3,avg}$

Min. Input Capacitor Current during t_d : $I_{C_i,min,t_d} = I_{N_p,avg} - I_{D_3,avg}$

Max. Input Capacitor Current during t_d : $I_{C_i,max,t_d} = I_{N_p,avg} - I_{D_3,avg} + I_{mag}$

Input Capacitor Current after t_d : $I_{C_i,t_d} = I_{N_p,avg} - I_{D_3,avg}$

Input Capacitor Current during t_3 : $I_{C_i,t_3} = I_{N_p,avg} - I_{D_3,avg}$

Average Input Capacitor Current: $I_{C_i,avg} = 0A$

Input Capacitor Voltage: $V_{C_i} = V_{in}$

12.11. Output Capacitor C_o

12.11.1. CCM & DCM.

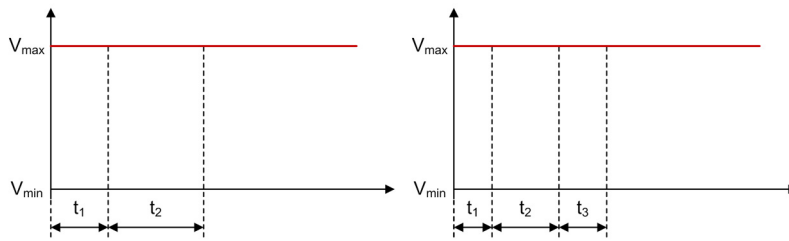

Figure 12.11.1. Single Switch Forward - Output Capacitor C_o Voltage Waveforms in CCM and DCM

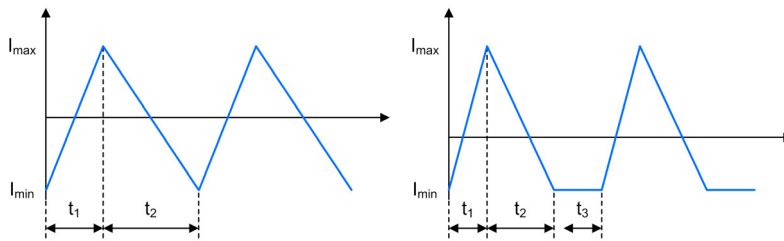

Figure 12.11.2. Single Switch Forward - Output Capacitor C_o Current Waveforms in CCM and DCM

Min. Output Capacitor Current: $I_{C_o,min} = I_{L_1,min} - I_{out}$

Max. Output Capacitor Current: $I_{C_o,max} = I_{L_1,max} - I_{out}$

Average Output Capacitor Current: $I_{C_o,avg} = 0A$

Output Capacitor Voltage: $V_{C_o} = V_{out}$

Two Switch Forward Converter

A Two Switch Forward regulator converts an input voltage to a higher or lower, positive or negative output voltage level. The energy is transferred to the output when the FETs are conducting.

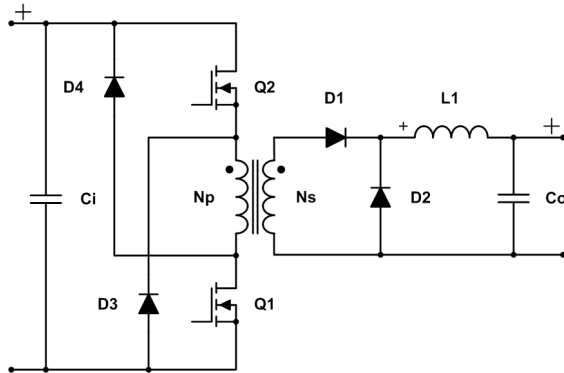

Figure 13.0.1. Schematic of a Two Switch Forward converter

13.1. General

Secondary Side Inductance:
$$L_s = \frac{L_p}{\left(\frac{n_s}{n_p}\right)^2}$$

Inductor Current Ripple:
$$I_{ripple} = \frac{1}{L_1} \cdot \left(V_{in} \cdot \frac{n_s}{n_p} - V_f - V_{out} \right) \cdot t_1$$

13.1.1. Continuous Conduction Mode.

$$\begin{aligned} \text{FETs on, increasing current:} \quad t_1 &= \frac{1}{f_{switch}} \cdot \frac{V_{out}+V_f}{V_{in} \cdot \frac{n_s}{n_p}} \\ \text{Demagnetization Time:} \quad t_d &= t_1 \\ \text{FETs off, decreasing current:} \quad t_2 &= \frac{1}{f_{switch}} - t_1 \\ \text{Magnetization Current:} \quad I_{mag} &= \frac{V_{in} \cdot t_1}{L_p} \\ \text{Min. Secondary Current:} \quad I_{sec,min} &= I_{out} - \frac{1}{2} \cdot I_{ripple} \\ \text{Max. Secondary Current:} \quad I_{sec,max} &= I_{out} + \frac{1}{2} \cdot I_{ripple} \\ \text{Min. Primary Current:} \quad I_{pri,max} &= I_{sec,min} \cdot \frac{n_s}{n_p} \\ \text{Max. Primary Current:} \quad I_{pri,max} &= I_{sec,max} \cdot \frac{n_s}{n_p} + I_{mag} \\ \text{Average Input Current:} \quad I_{in,avg} &= \frac{(V_{out}+V_f) \cdot I_{out}}{V_{in}} \end{aligned}$$

13.1.2. Discontinuous Conduction Mode.

$$\begin{aligned} \text{FETs on, increasing current:} \quad t_1 &= \sqrt{2 \cdot I_{out} \cdot L_1 \cdot \frac{V_{out}+V_f}{f_{switch} \cdot \left(V_{in} \cdot \frac{n_s}{n_p} - V_f - V_{out} \right) \cdot \left(V_{in} \cdot \frac{n_s}{n_p} \right)}} \\ \text{Demagnetization Time:} \quad t_d &= t_1 \\ \text{FETs off, decreasing current:} \quad t_2 &= t_1 \cdot \frac{V_{in} \cdot \frac{n_s}{n_p}}{(V_{out}+V_f)} - t_1 \\ \text{FETs off, no current (if } t_2 > t_d \text{):} \quad t_3 &= \frac{1}{f_{switch}} - t_1 - t_2 \\ \text{FETs off, no current (if } t_d \geq t_2 \text{):} \quad t_3 &= \frac{1}{f_{switch}} - t_1 - t_d \\ \text{Magnetization Current:} \quad I_{mag} &= \frac{V_{in} \cdot t_1}{L_p} \\ \text{Min. Secondary Current:} \quad I_{sec,min} &= 0A \\ \text{Max. Secondary Current:} \quad I_{sec,max} &= I_{ripple} \\ \text{Min. Primary Current:} \quad I_{pri,max} &= 0A \\ \text{Max. Primary Current:} \quad I_{pri,max} &= I_{sec,max} \cdot \frac{n_s}{n_p} + I_{mag} \\ \text{Average Input Current:} \quad I_{in,avg} &= \frac{(V_{out}+V_f) \cdot I_{out}}{V_{in}} \end{aligned}$$

13.2. Primary Side Transformer Winding N_p

13.2.1. CCM & DCM.

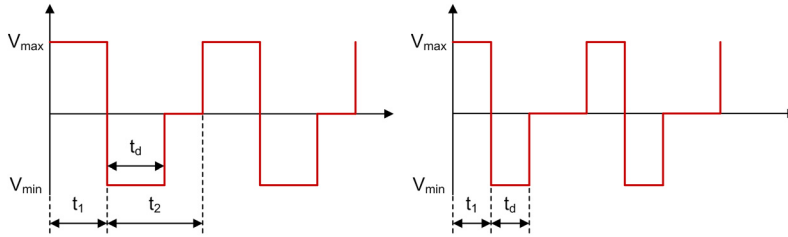

Figure 13.2.1. Two Switch Forward - Primary Side Transformer Winding N_p Voltage Waveforms in CCM and DCM

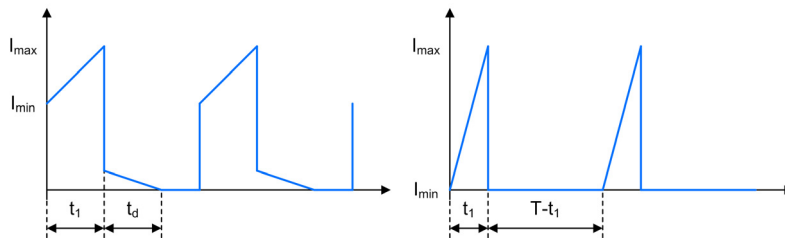

Figure 13.2.2. Two Switch Forward - Primary Side Transformer Winding N_p Current Waveforms in CCM and DCM

Average Primary Transformer Current:
$$I_{N_p,avg} = \left(\frac{I_{pri,min} + I_{pri,max}}{2} \cdot t_1 + \frac{I_{mag}}{2} \cdot t_d \right) \cdot f_{switch}$$

Min. Primary Transformer Current during t_1 :
$$I_{N_p,min,t_1} = I_{pri,min}$$

Max. Primary Transformer Current during t_1 :
$$I_{N_p,max,t_1} = I_{pri,max}$$

Min. Primary Transformer Current during t_2 :
$$I_{N_p,min,t_2} = 0V$$

Max. Primary Transformer Current during t_2 :
$$I_{N_p,max,t_2} = I_{mag}$$

Min. Primary Transformer Voltage:
$$V_{N_p,min} = -V_{in} - 2 \cdot V_f$$

Max. Primary Transformer Voltage:
$$V_{N_p,max} = V_{in}$$

Primary Transformer Voltage after t_d :
$$V_{N_p,t_{ad}} = 0V$$

Primary Transformer Voltage during t_3 :
$$V_{N_p,t_3} = 0V$$

13.3. Secondary Side Transformer Winding N_s

13.3.1. CCM & DCM.

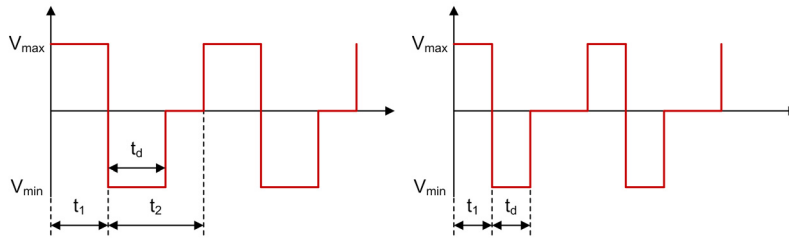

Figure 13.3.1. Two Switch Forward - Secondary Side Transformer Winding N_s Voltage Waveforms in CCM and DCM

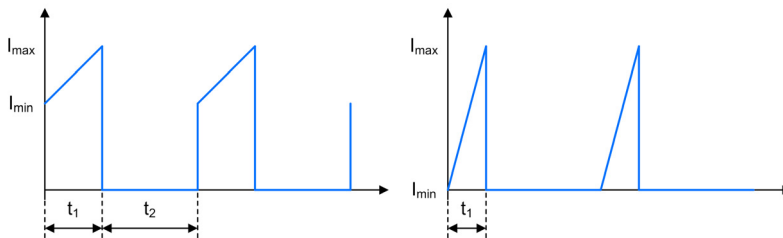

Figure 13.3.2. Two Switch Forward - Secondary Side Transformer Winding N_s Current Waveforms in CCM and DCM

Average Secondary Transformer Current:
$$I_{N_s,avg} = \frac{I_{sec,min} + I_{sec,max}}{2} \cdot t_1 \cdot f_{switch}$$

Min. Secondary Transformer Current:
$$I_{N_s,min} = I_{sec,min}$$

Max. Secondary Transformer Current:
$$I_{N_s,max} = I_{sec,max}$$

Min. Secondary Transformer Voltage:
$$V_{N_s,min} = -(V_{in} + 2 \cdot V_f) \cdot \frac{n_s}{n_p}$$

Max. Secondary Transformer Voltage:
$$V_{N_s,max} = V_{in} \cdot \frac{n_s}{n_p}$$

Secondary Transformer Voltage after t_d :
$$V_{N_s,t_{ad}} = 0V$$

Secondary Transformer Voltage during t_3 :
$$V_{N_s,t_3} = 0V$$

13.4. Inductor L_1

13.4.1. CCM & DCM.

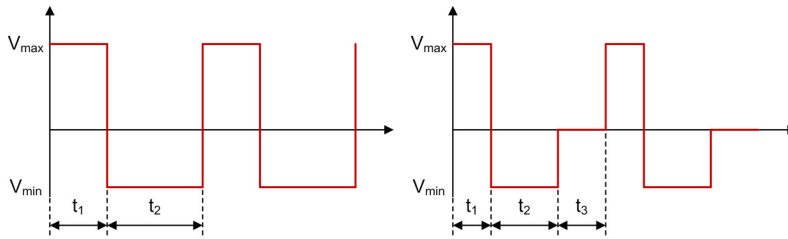

Figure 13.4.1. Two Switch Forward - Inductor L_1 Voltage Waveforms in CCM and DCM

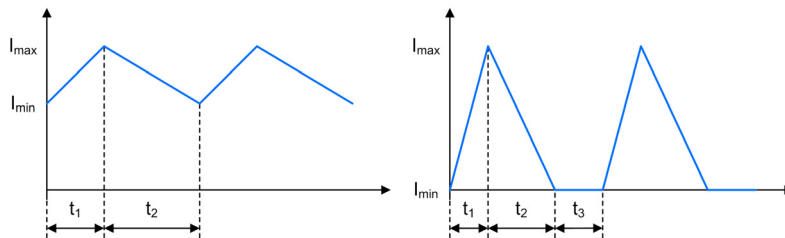

Figure 13.4.2. Two Switch Forward - Inductor L_1 Current Waveforms in CCM and DCM

Average Inductor Current:
$$I_{ind,avg} = \frac{I_{sec,max} + I_{sec,min}}{2} \cdot (t_1 + t_2) \cdot f_{switch}$$

Min. Inductor Current:
$$I_{ind,min} = I_{trans,sec,min}$$

Max. Inductor Current:
$$I_{ind,max} = I_{trans,sec,max}$$

Min. Inductor Voltage:
$$V_{ind,min} = -V_{out} - V_f$$

Max. Inductor Voltage:
$$V_{ind,max} = V_{in} \cdot \frac{n_s}{n_p} - V_{out} - V_f$$

Inductor Voltage during t_3 :
$$V_{ind,t_3} = 0V$$

13.5. FET Q_1/Q_2

13.5.1. CCM & DCM.

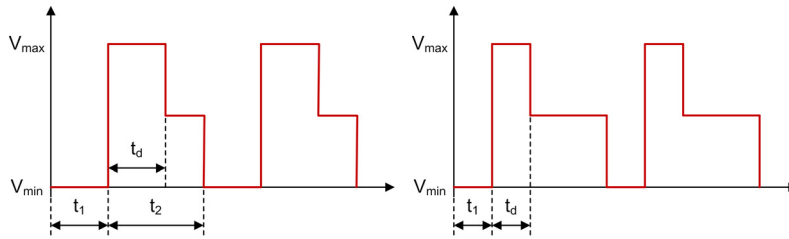

Figure 13.5.1. Two Switch Forward - FET Q_1/Q_2 Voltage Waveforms in CCM and DCM

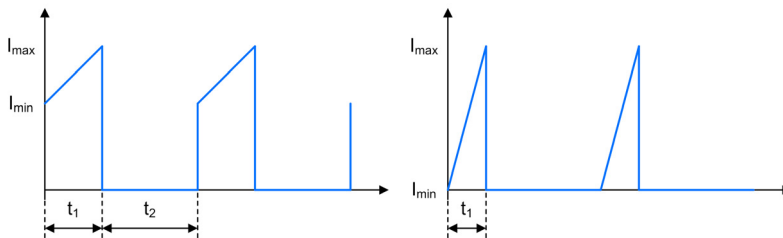

Figure 13.5.2. Two Switch Forward - FET Q_1/Q_2 Current Waveforms in CCM and DCM

Average FET Current: $I_{Q_{1/2},avg} = I_{N_p,avg}$

Min. FET Current: $I_{Q_{1/2},min} = I_{pri,min}$

Max. FET Current: $I_{Q_{1/2},max} = I_{pri,max}$

Min. FET Voltage: $V_{Q_{1/2},min} = 0V$

Max. FET Voltage: $V_{Q_{1/2},max} = V_{in} + V_f$

FET Voltage after t_d : $V_{Q_{1/2},t_d} = \frac{1}{2} \cdot V_{in}$

FET Voltage during t_3 : $V_{Q_{1/2},t_3} = \frac{1}{2} \cdot V_{in}$

13.6. Demagnetization Diode D_3/D_4

13.6.1. CCM & DCM.

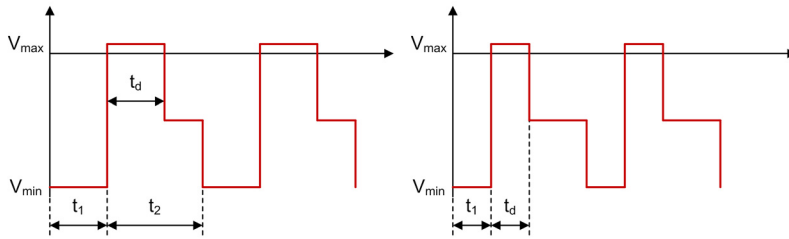

Figure 13.6.1. Two Switch Forward - Demagnetization Diode D_3/D_4 Voltage Waveforms in CCM and DCM

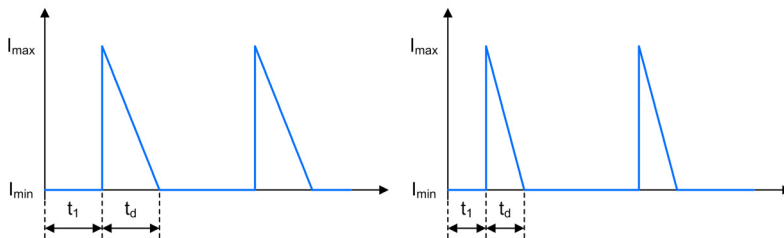

Figure 13.6.2. Two Switch Forward - Demagnetization Diode D_3/D_4 Current Waveforms in CCM and DCM

Average Demagnetization Diode Current:
$$I_{D_{3/4},avg} = \frac{I_{mag}}{2} \cdot t_d \cdot f_{switch}$$

Min. Demagnetization Diode Current:
$$I_{D_{3/4},min} = 0A$$

Max. Demagnetization Diode Current:
$$I_{D_{3/4},max} = I_{mag}$$

Min. Demagnetization Diode Voltage:
$$V_{D_{3/4},min} = -V_{in}$$

Max. Demagnetization Diode Voltage:
$$V_{D_{3/4},max} = V_f$$

Demagnetization Diode Voltage after t_d :
$$V_{D_{3/4},t_{ad}} = -\frac{1}{2} \cdot V_{in}$$

Demagnetization Diode Voltage during t_3 :
$$V_{D_{3/4},t_3} = -\frac{1}{2} \cdot V_{in}$$

13.7. Rectifier Diode D_1

13.7.1. CCM & DCM.

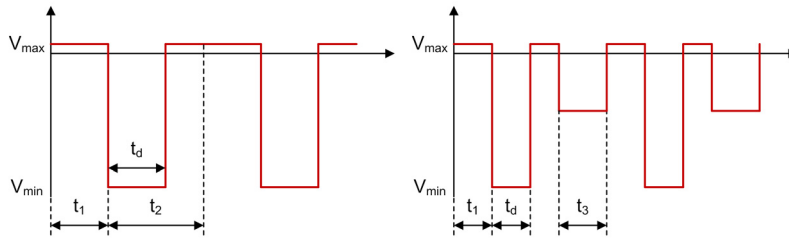

Figure 13.7.1. Two Switch Forward - Rectifier Diode D_1 Voltage Waveforms in CCM and DCM

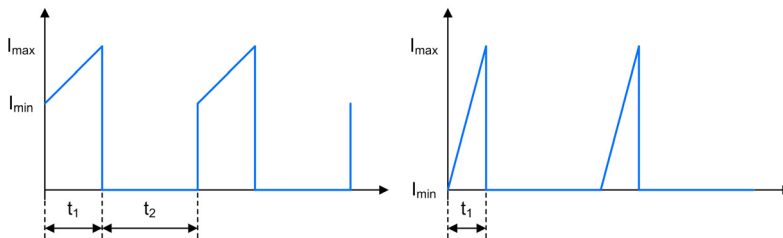

Figure 13.7.2. Two Switch Forward - Rectifier Diode D_1 Current Waveforms in CCM and DCM

Average Rectifier Diode Current:
$$I_{D_1,avg} = \frac{I_{N_s,min} + I_{N_s,max}}{2} \cdot t_2 \cdot f_{switch}$$

Min. Rectifier Diode Current:
$$I_{D_1,min} = I_{N_s,min}$$

Max. Rectifier Diode Current:
$$I_{D_1,max} = I_{N_s,max}$$

Min. Rectifier Diode Voltage:
$$V_{D_1,min} = -(V_{in} + 2 \cdot V_f) \cdot \frac{n_s}{n_p} + V_f$$

Max. Rectifier Diode Voltage:
$$V_{D_1,max} = V_f$$

Rectifier Diode Voltage after t_d :
$$V_{D_1,t_{ad}} = V_f$$

Rectifier Diode Voltage during t_3 :
$$V_{D_1,t_3} = -V_{out}$$

13.8. Freewheeling Diode D_2

13.8.1. CCM & DCM.

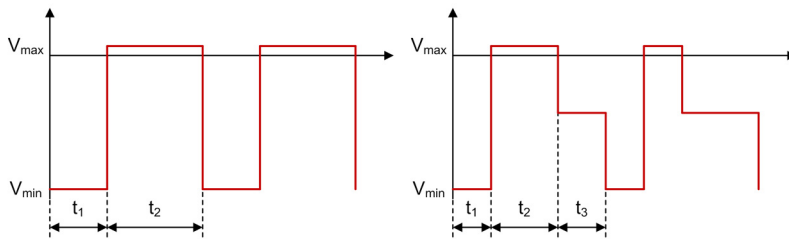

Figure 13.8.1. Two Switch Forward - Freewheeling Diode D_2 Voltage Waveforms in CCM and DCM

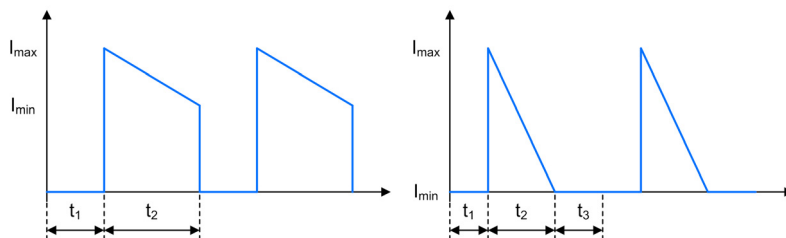

Figure 13.8.2. Two Switch Forward - Freewheeling Diode D_2 Current Waveforms in CCM and DCM

Average Freewheeling Diode Current: $I_{D_2,avg} = I_{N_s,avg}$

Min. Freewheeling Diode Current: $I_{D_2,min} = I_{N_s,min}$

Max. Freewheeling Diode Current: $I_{D_2,max} = I_{N_s,max}$

Min. Freewheeling Diode Voltage: $V_{D_2,min} = -V_{in} \cdot \frac{n_s}{n_p} + V_f$

Max. Freewheeling Diode Voltage: $V_{D_2,max} = V_f$

Freewheeling Diode Voltage during t_3 : $V_{D_2,t_3} = -V_{out}$

13.9. Input Capacitor C_i

13.9.1. CCM & DCM.

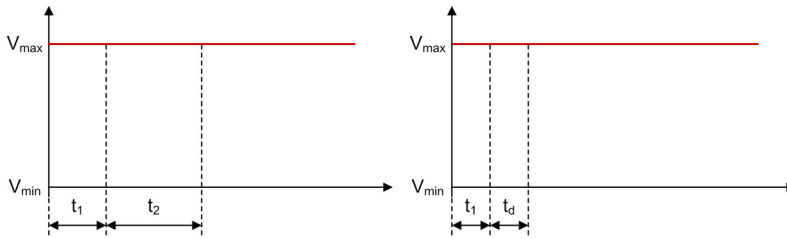

Figure 13.9.1. Two Switch Forward - Input Capacitor C_i Voltage Waveforms in CCM and DCM

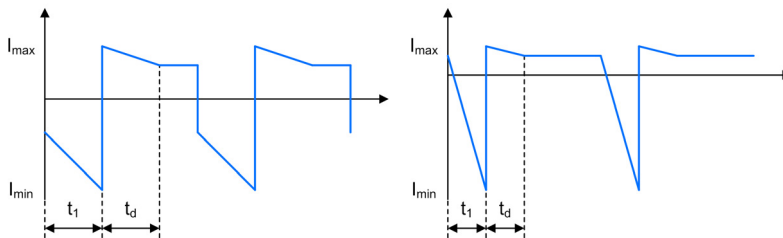

Figure 13.9.2. Two Switch Forward - Input Capacitor C_i Current Waveforms in CCM and DCM

Min. Input Capacitor Current during t_1 : $I_{C_i,min,t_1} = I_{N_p,avg} - I_{N_p,max} - I_{D_{3/4},avg}$

Max. Input Capacitor Current during t_1 : $I_{C_i,max,t_1} = I_{N_p,avg} - I_{N_p,min} - I_{D_{3/4},avg}$

Min. Input Capacitor Current during t_d : $I_{C_i,min,t_{2/3}} = I_{N_p,avg} - I_{D_{3/4},avg}$

Max. Input Capacitor Current during t_d : $I_{C_i,max,t_{2/3}} = I_{N_p,avg} - I_{D_{3/4},avg} + I_{mag}$

Input Capacitor Current after t_d : $I_{C_i,t_{ad}} = I_{N_p,avg} - I_{D_{3/4},avg}$

Input Capacitor Current during t_3 : $I_{C_i,t_3} = I_{N_p,avg} - I_{D_{3/4},avg}$

Average Input Capacitor Current: $I_{C_i,avg} = 0A$

Input Capacitor Voltage: $V_{C_i} = V_{in}$

13.10. Output Capacitor C_o

13.10.1. CCM & DCM.

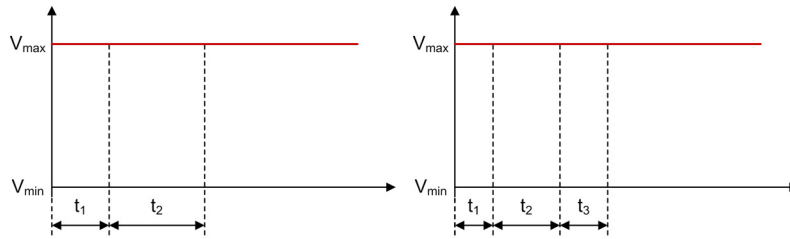

Figure 13.10.1. Two Switch Forward - Output Capacitor C_o Voltage Waveforms in CCM and DCM

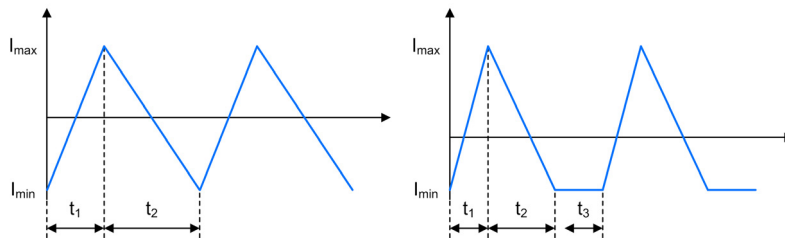

Figure 13.10.2. Two Switch Forward - Output Capacitor C_o Current Waveforms in CCM and DCM

Min. Output Capacitor Current: $I_{C_o,min} = I_{L_1,min} - I_{out}$

Max. Output Capacitor Current: $I_{C_o,max} = I_{L_1,max} - I_{out}$

Average Output Capacitor Current: $I_{C_o,avg} = 0A$

Output Capacitor Voltage: $V_{C_o} = V_{out}$

Push-Pull Converter

A Push-Pull regulator converts an input voltage to a higher or lower, positive or negative output voltage level. The energy is transferred to the output when the FETs are conducting.

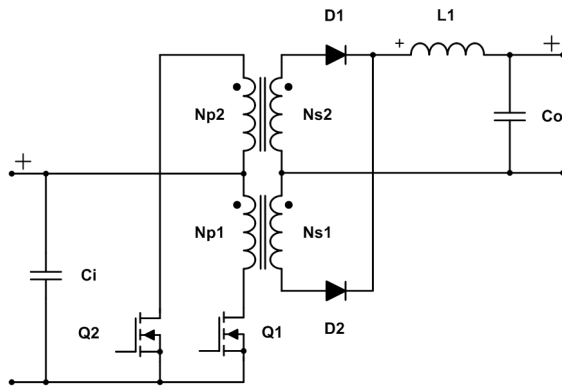

Figure 14.0.1. Schematic of a Push-Pull converter

14.1. General

Secondary Side Inductance:
$$L_s = \frac{L_p}{\left(\frac{n_p}{n_s}\right)^2}$$

Inductor Current Ripple:
$$I_{ripple} = \frac{1}{L_1} \cdot (V_{in} \cdot \frac{n_s}{n_p} - V_f - V_{out}) \cdot t_1$$

Magnetization Current:
$$I_{mag} = \frac{V_{in} \cdot t_1}{L_p}$$

14.1.1. Continuous Conduction Mode.

$$\begin{aligned} \text{FET on, increasing current:} \quad t_1 &= \frac{1}{2 \cdot f_{\text{switch}}} \cdot \frac{V_{\text{out}} + V_f}{V_{\text{in}} \cdot \frac{n_s}{n_p}} \\ \text{FET off, decreasing current:} \quad t_2 &= \frac{1}{2 \cdot f_{\text{switch}}} - t_1 \\ \text{Min. Secondary Current:} \quad I_{\text{sec,min}} &= I_{\text{out}} - \frac{1}{2} \cdot I_{\text{ripple}} \\ \text{Max. Secondary Current:} \quad I_{\text{sec,max}} &= I_{\text{out}} + \frac{1}{2} \cdot I_{\text{ripple}} \\ \text{Min. Primary Current:} \quad I_{\text{pri,min}} &= I_{\text{sec,min}} \cdot \frac{n_s}{n_p} - \frac{1}{2} \cdot I_{\text{mag}} \\ \text{Max. Primary Current:} \quad I_{\text{pri,max}} &= I_{\text{sec,max}} \cdot \frac{n_s}{n_p} + \frac{1}{2} \cdot I_{\text{mag}} \\ \text{Average Input Current:} \quad I_{\text{in,avg}} &= \frac{(V_{\text{out}} + V_f) \cdot I_{\text{out}}}{V_{\text{in}}} \end{aligned}$$

14.1.2. Discontinuous Conduction Mode.

$$\begin{aligned} \text{FET on, increasing current:} \quad t_1 &= \sqrt{2 \cdot I_{\text{out}} \cdot L_1 \cdot \frac{V_{\text{out}} + V_f}{2 \cdot f_{\text{switch}} \cdot (V_{\text{in}} \cdot \frac{n_s}{n_p} - V_f - V_{\text{out}}) \cdot (V_{\text{in}} \cdot \frac{n_s}{n_p})}} \\ \text{FET off, decreasing current:} \quad t_2 &= t_1 \cdot \frac{V_{\text{in}} \cdot \frac{n_s}{n_p}}{(V_{\text{out}} + V_f)} - t_1 \\ \text{FET off, demagnetization:} \quad t_3 &= \frac{1}{2 \cdot f_{\text{switch}}} - t_1 - t_2 \\ \text{Min. Secondary Current:} \quad I_{\text{sec,min}} &= 0A \\ \text{Max. Secondary Current:} \quad I_{\text{sec,max}} &= I_{\text{ripple}} \\ \text{Min. Primary Current:} \quad I_{\text{pri,max}} &= 0A \\ \text{Max. Primary Current:} \quad I_{\text{pri,max}} &= I_{\text{sec,max}} \cdot \frac{n_s}{n_p} + \frac{1}{2} \cdot I_{\text{mag}} \\ \text{Average Input Current:} \quad I_{\text{in,avg}} &= \frac{(V_{\text{out}} + V_f) \cdot I_{\text{out}}}{V_{\text{in}}} \end{aligned}$$

14.2. Primary Side Transformer Windings N_{p1} and N_{p2}

14.2.1. CCM.

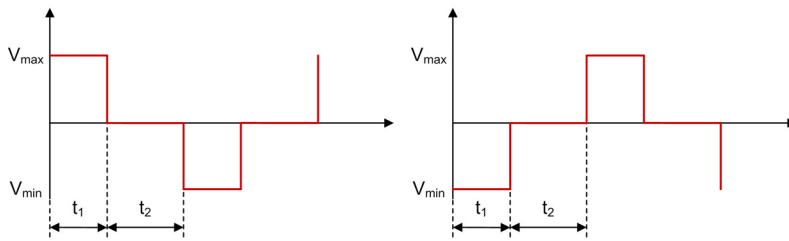

Figure 14.2.1. Push-Pull - Primary Side Transformer Windings N_{p1} and N_{p2} Voltage Waveforms in CCM

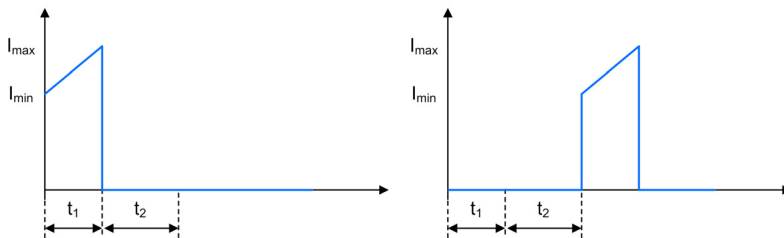

Figure 14.2.2. Push-Pull - Primary Side Transformer Windings N_{p1} and N_{p2} Current Waveforms in CCM

Average Primary Side Transformer Current:
$$I_{N_{p1/p2},avg} = \frac{I_{pri,min} + I_{pri,max}}{2} \cdot t_1 \cdot f_{switch}$$

Min. Primary Side Transformer Current:
$$I_{N_{p1/p2},min} = I_{pri,min}$$

Max. Primary Side Transformer Current:
$$I_{N_{p1/p2},max} = I_{pri,max}$$

Min. Primary Side Transformer Voltage:
$$V_{N_{p1/p2},min} = -V_{in}$$

Max. Primary Side Transformer Voltage:
$$V_{N_{p1/p2},max} = V_{in}$$

14.2.2. DCM.

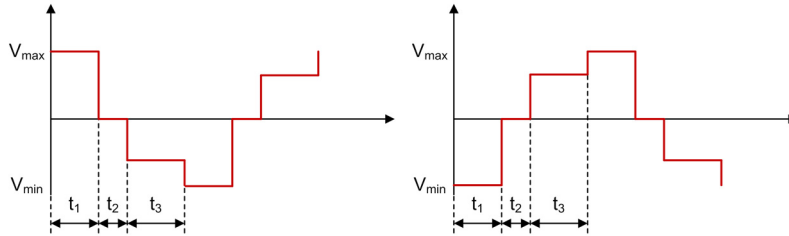

Figure 14.2.3. Push-Pull - Primary Side Transformer Windings N_{p1} and N_{p2} Voltage Waveforms in DCM

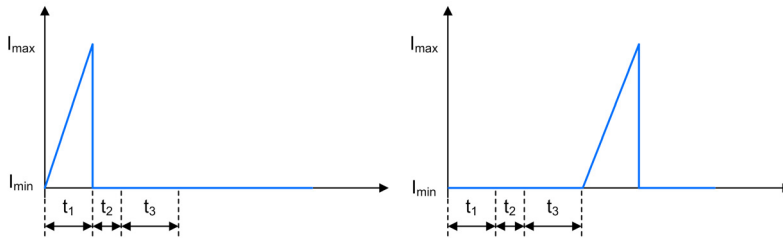

Figure 14.2.4. Push-Pull - Primary Side Transformer Windings N_{p1} and N_{p2} Current Waveforms in DCM

Average Primary Transformer Current: $I_{N_{p1/p2},avg} = \frac{I_{pri,max}}{2} \cdot t_1 \cdot f_{switch}$

Min. Primary Transformer Current: $I_{N_{p1/p2},min} = I_{pri,min}$

Max. Primary Transformer Current: $I_{N_{p1/p2},max} = I_{pri,max}$

Min. Primary Transformer Voltage: $V_{N_{p1/p2},min} = -V_{in}$

Max. Primary Transformer Voltage: $V_{N_{p1/p2},max} = V_{in}$

Min. Primary Transformer Voltage during t_3 : $V_{N_{p1/p2},min,t_3} = (V_{out} + V_f) \cdot \frac{n_p}{n_s}$

Min. Primary Transformer Voltage during t_3 : $V_{N_{p1/p2},max,t_3} = -(V_{out} + V_f) \cdot \frac{n_p}{n_s}$

14.3. Secondary Side Transformer Windings N_{s1} and N_{s2}

14.3.1. CCM & DCM.

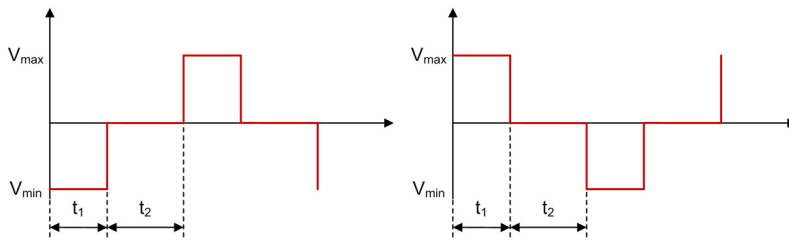

Figure 14.3.1. Push-Pull - Secondary Side Transformer Windings N_{s1} and N_{s2} Voltage Waveforms in CCM

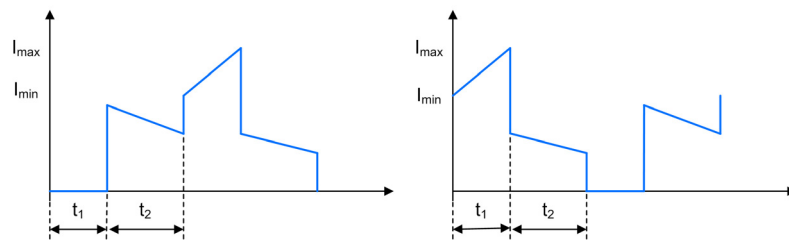

Figure 14.3.2. Push-Pull - Secondary Side Transformer Windings N_{s1} and N_{s2} Current Waveforms in CCM

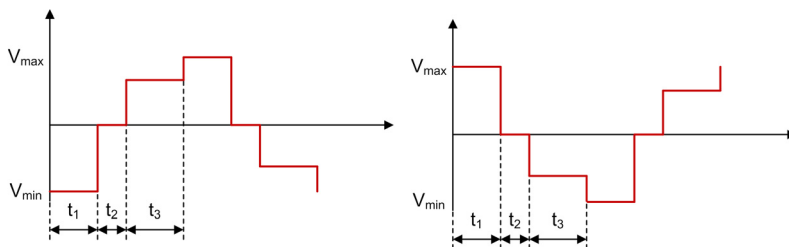

Figure 14.3.3. Push-Pull - Secondary Side Transformer Windings N_{s1} and N_{s2} Voltage Waveforms in DCM

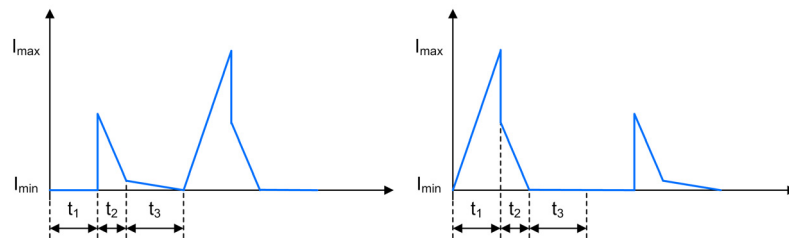

Figure 14.3.4. Push-Pull - Secondary Side Transformer Windings N_{s1} and N_{s2} Current Waveforms in DCM

Average Secondary Transformer Current:	$I_{N_{s1/s2},avg} = \frac{I_{sec,min} + I_{sec,max}}{2} \cdot t_1 \cdot f_{switch}$
Min. Secondary Transformer Current (t_1 of FET):	$I_{N_{s1/s2},min} = I_{sec,min}$
Max. Secondary Transformer Current (t_1 of FET):	$I_{N_{s1/s2},max} = I_{sec,max}$
Min. Secondary Transformer Current (t_2 of other FET):	$I_{N_{s1/s2},min,t_2,other} = \frac{I_{pri,max}}{2 \cdot \frac{n_s}{n_p}} - \frac{I_{ripple}}{2}$
Max. Secondary Transformer Current (t_2 of other FET):	$I_{N_{s1/s2},max,t_2,other} = \frac{I_{pri,max}}{2 \cdot \frac{n_s}{n_p}}$
Min. Secondary Transformer Current (t_2 of FET, CCM):	$I_{N_{s1/s2},min,t_2} = I_{sec,min} - I_{N_{s1/s2},min,t_2,other}$
Min. Secondary Transformer Current (t_2 of FET, DCM):	$I_{N_{s1/s2},min,t_2} = 0A$
Max. Secondary Transformer Current (t_2 of FET):	$I_{N_{s1/s2},max,t_2} = I_{sec,max} - I_{N_{s1/s2},max,t_2,other}$
Min. Secondary Transformer Current during t_3 :	$I_{N_{s1/s2},min,t_3} = 0A$
Max. Secondary Transformer Current during t_3 :	$I_{N_{s1/s2},max,t_3} = I_{N_{s1/s2},max,t_2,other} - I_{N_{s1/s2},max,t_2}$
Min. Secondary Transformer Voltage:	$V_{N_{s1/s2},min} = -V_{in} \cdot \frac{n_s}{n_p}$
Max. Secondary Transformer Voltage:	$V_{N_{s1/s2},max} = V_{in} \cdot \frac{n_s}{n_p}$
Min. Secondary Transformer Voltage during t_3 :	$V_{N_{s1/s2},min,t_3} = -V_{out} - V_f$
Max. Secondary Transformer Voltage during t_3 :	$V_{N_{s1/s2},max,t_3} = V_{out} + V_f$

14.4. Inductor L_1

14.4.1. CCM & DCM.

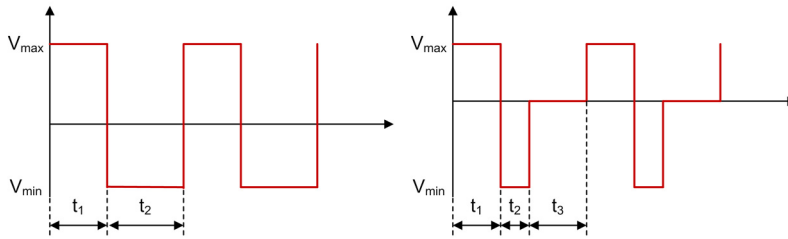

Figure 14.4.1. Push-Pull - Inductor L_1 Voltage Waveforms in CCM and DCM

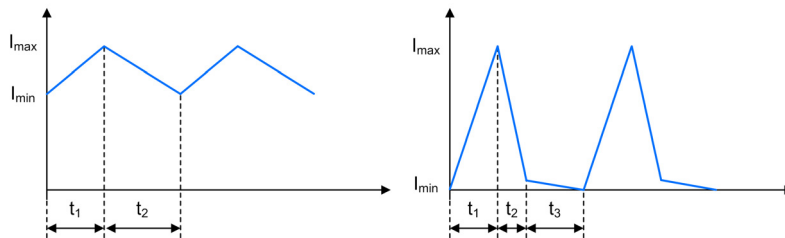

Figure 14.4.2. Push-Pull - Inductor L_1 Current Waveforms in CCM and DCM

- Average Inductor Current: $I_{L_1,avg} = \frac{I_{sec,max} + I_{sec,min}}{2}$
- Min. Inductor Current: $I_{L_1,min} = I_{sec,min}$
- Max. Inductor Current: $I_{L_1,max} = I_{sec,max}$
- Min. Inductor Current during t_3 : $I_{L_1,min,t_3} = I_{N_{s1/s2},min,t_3}$
- Max. Inductor Current during t_3 : $I_{L_1,max,t_3} = I_{N_{s1/s2},max,t_3}$
- Min. Inductor Voltage: $V_{L_1,min} = -V_{out} - V_f$
- Max. Inductor Voltage: $V_{L_1,max} = V_{in} \cdot \frac{n_s}{n_p} - V_{out} - V_f$
- Inductor Voltage during t_3 : $V_{L_1,t_3} = 0V$

14.5. FET Q_1 & Q_2

14.5.1. CCM.

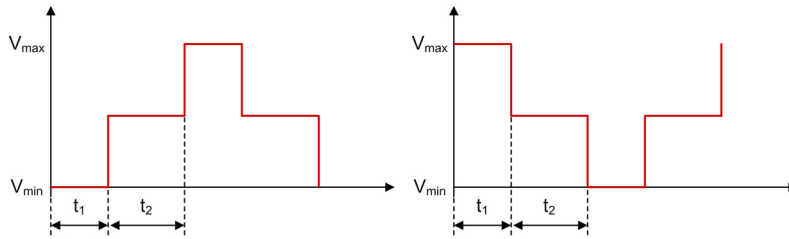

Figure 14.5.1. Push-Pull - FETs Q_1 and Q_2 Voltage Waveforms in CCM

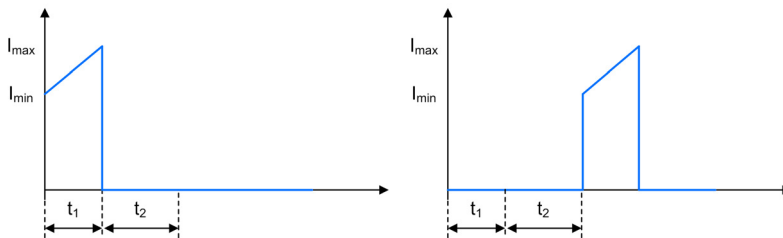

Figure 14.5.2. Push-Pull - FETs Q_1 & Q_2 Current Waveforms in CCM

Average FET Current:	$I_{Q_{1/2},avg} = I_{N_{p1/p2},avg}$
Min. FET Current:	$I_{Q_{1/2},min} = I_{pri,min}$
Max. FET Current:	$I_{Q_{1/2},max} = I_{pri,max}$
Min. FET Voltage during t_1 :	$V_{Q_{1/2},min,t_1} = 0V$
Max. FET Voltage during t_1 (t_1 of other FET):	$V_{Q_{1/2},max,t_1} = 2 \cdot V_{in}$
FET Voltage during t_2 :	$V_{Q_{1/2},t_2} = V_{in}$

14.5.2. DCM.

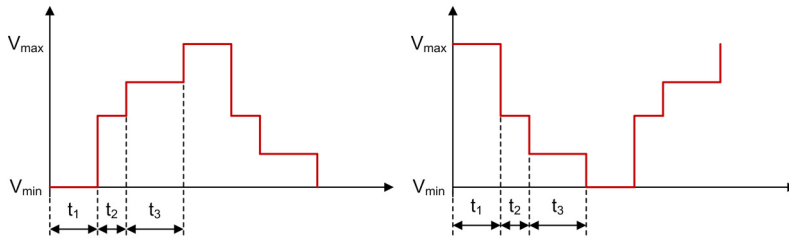

Figure 14.5.3. Push-Pull - FETs Q_1 and Q_2 Voltage Waveforms in DCM

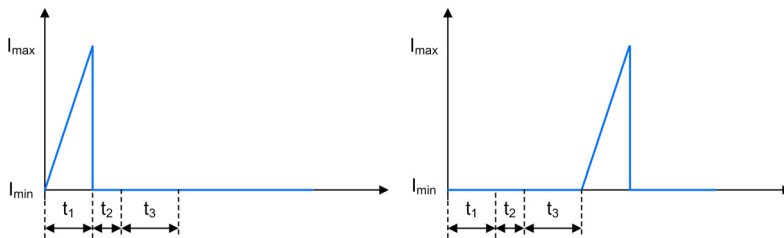

Figure 14.5.4. Push-Pull - FETs Q_1 and Q_2 Current Waveforms in DCM

Average FET Current:

$$I_{Q_{1/2},avg} = I_{N_{p1/p2},avg}$$

Min. FET Current:

$$I_{Q_{1/2},min} = I_{pri,min}$$

Max. FET Current:

$$I_{Q_{1/2},max} = I_{pri,max}$$

Min. FET Voltage during t_1 :

$$V_{Q_{1/2},min,t_1} = 0V$$

Max. FET Voltage during t_1 (t_1 of other FET):

$$V_{Q_{1/2},max,t_1} = 2 \cdot V_{in}$$

FET Voltage during t_2 :

$$V_{Q_{1/2},t_2} = V_{in}$$

Min. FET Voltage during t_3 (t_3 of other FET):

$$V_{Q_{1/2},min,t_3} = V_{in} - (V_{out} + V_f) \cdot \frac{n_p}{n_s}$$

Max. FET Voltage during t_3 :

$$V_{Q_{1/2},max,t_3} = V_{in} + (V_{out} + V_f) \cdot \frac{n_p}{n_s}$$

14.6. Rectifier Diode D_1 & D_2

14.6.1. CCM & DCM.

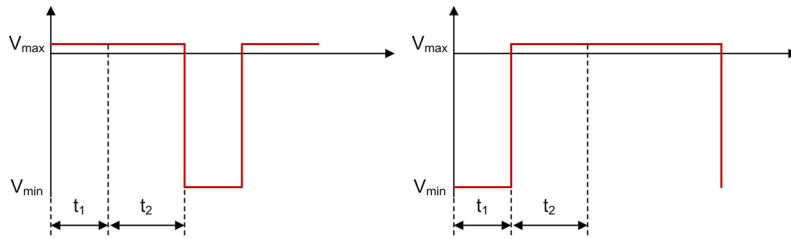

Figure 14.6.1. Push-Pull - Rectifier Diodes D_1 and D_2 Voltage Waveforms in CCM

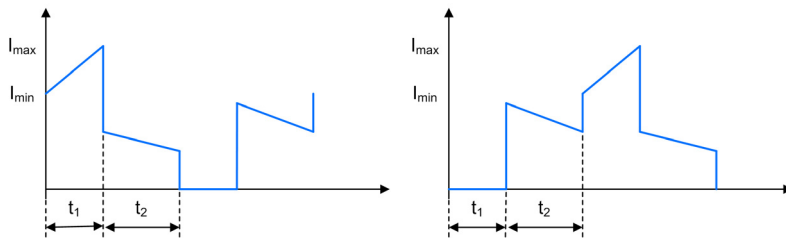

Figure 14.6.2. Push-Pull - Rectifier Diodes D_1 and D_2 Current Waveforms in CCM

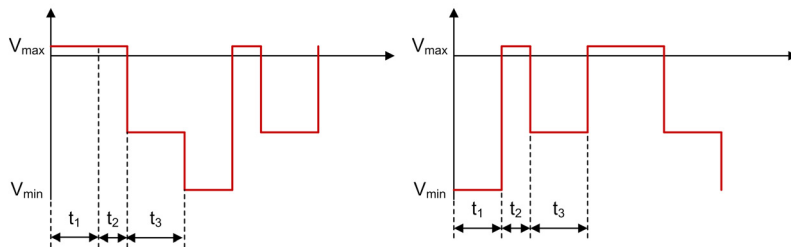

Figure 14.6.3. Push-Pull - Rectifier Diodes D_1 and D_2 Voltage Waveforms in DCM

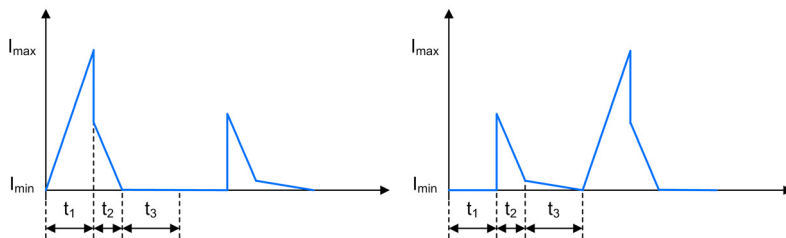

Figure 14.6.4. Push-Pull - Rectifier Diodes D_1 and D_2 Current Waveforms in DCM

Average Rectifier Diode Current:	$I_{D_{1/2},avg} = I_{N_{s1/s2},avg}$
Min. Rectifier Diode Current (t_1 of FET):	$I_{D_{1/2},min,t_1} = I_{sec,min}$
Max. Rectifier Diode Current (t_1 of FET):	$I_{D_{1/2},max,t_1} = I_{sec,max}$
Min. Rectifier Diode Current (t_2 of other FET):	$I_{D_{1/2},min,t_2,other} = \frac{I_{pri,max}}{2 \cdot \frac{n_s}{n_p}} - \frac{I_{ripple}}{2}$
Max. Rectifier Diode Current (t_2 of other FET):	$I_{D_{1/2},max,t_2,other} = \frac{I_{pri,max}}{2 \cdot \frac{n_s}{n_p}}$
Min. Rectifier Diode Current (t_2 of FET):	$I_{D_{1/2},min,t_2} = I_{sec,min} - I_{N_s,min,t_2,other}$
Max. Rectifier Diode Current (t_2 of FET):	$I_{D_{1/2},max,t_2} = I_{sec,max} - I_{N_s,max,t_2,other}$
Min. Rectifier Diode Current (t_3 of other FET):	$I_{D_{1/2},min,t_3,other} = I_{N_s,min,t_3}$
Max. Rectifier Diode Current (t_3 of other FET):	$I_{D_{1/2},max,t_3,other} = I_{N_s,max,t_3}$
Rectifier Diode Current (t_3 of FET):	$I_{D_{1/2},t_3} = 0A$
Min. Rectifier Diode Voltage:	$V_{D_{1/2},min} = -2 \cdot V_{in} \cdot \frac{n_s}{n_p} + V_f$
Max. Rectifier Diode Voltage:	$V_{D_{1/2},max} = V_f$
Rectifier Diode Voltage during t_3 :	$V_{D_{1/2},t_3} = -V_{out}$

14.7. Input Capacitor C_i

14.7.1. CCM & DCM.

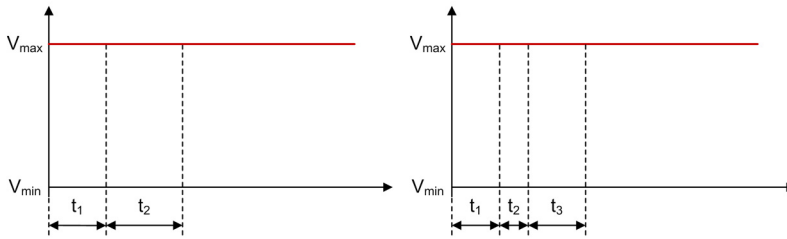

Figure 14.7.1. Push-Pull - Input Capacitor C_i Voltage Waveforms in CCM and DCM

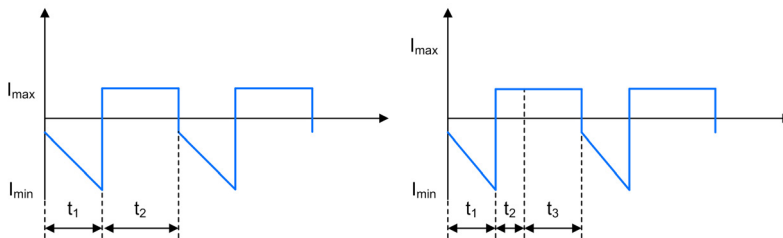

Figure 14.7.2. Push-Pull - Input Capacitor C_i Current Waveforms in CCM and DCM

Min. Input Capacitor Current during t_1 : $I_{C_i,min,t_1} = I_{N_p,avg} - I_{N_p,max}$

Max. Input Capacitor Current during t_1 : $I_{C_i,max,t_1} = I_{N_p,avg} - I_{N_p,min}$

Input Capacitor Current during t_2 and t_3 : $I_{C_i,t_2/3} = I_{N_p,avg}$

Average Input Capacitor Current: $I_{C_i,avg} = 0A$

Input Capacitor Voltage: $V_{C_i} = V_{in}$

14.8. Output Capacitor C_o

14.8.1. CCM & DCM.

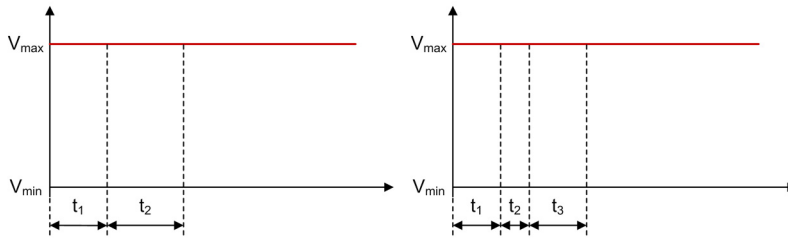

Figure 14.8.1. Push-Pull - Output Capacitor C_o Voltage Waveforms in CCM and DCM

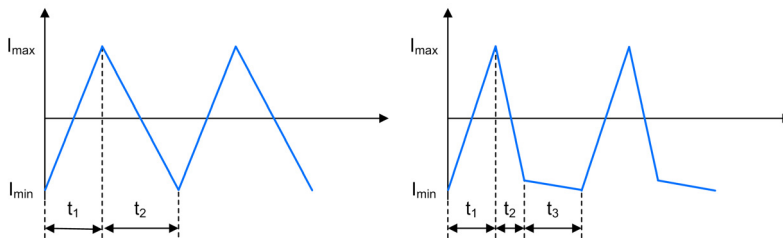

Figure 14.8.2. Push-Pull - Output Capacitor C_o Current Waveforms in CCM and DCM

- Min. Output Capacitor Current: $I_{C_o,min} = I_{sec,min} - I_{out}$
- Max. Output Capacitor Current: $I_{C_o,max} = I_{sec,max} - I_{out}$
- Min. Output Capacitor Current during t_3 : $I_{C_o,min,t_3} = I_{sec,min} - I_{out}$
- Max. Output Capacitor Current during t_3 : $I_{C_o,max,t_3} = I_{N_s,max,t_3} - I_{out}$
- Average Output Capacitor Current: $I_{C_o,avg} = 0A$
- Output Capacitor Voltage: $V_{C_o} = V_{out}$

Weinberg Converter

A Weinberg regulator is a Flyback current fed Push-Pull regulator and converts an input voltage to a higher or lower, positive or negative output voltage level. The energy is transferred to the output both when the FETs are conducting and not conducting.

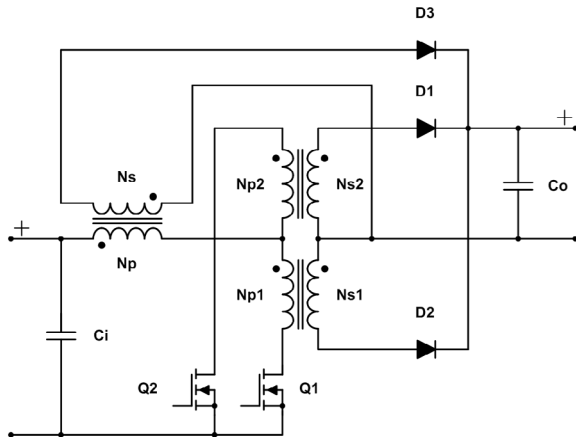

Figure 15.0.1. Schematic of a Weinberg converter

15.1. General

Secondary Side Inductance (Push-Pull):
$$L_{s,pushpull} = \frac{L_{p,pushpull}}{\left(\frac{n_p}{n_s}\right)^2}$$

Secondary Side Inductance (Flyback):
$$L_{s,flyback} = \frac{L_{p,flyback}}{\left(\frac{n_p}{n_s}\right)^2}$$

Inductor Current Ripple:
$$I_{ripple} = \frac{(V_{in} - (V_{out} + V_f) \cdot \frac{n_p}{n_s}) \cdot t_1}{L_{p,flyback}}$$

Magnetization Current:
$$I_{mag} = \frac{(V_{out} + V_f) \cdot \frac{n_p}{n_s} \cdot t_1}{L_{p,pushpull}}$$

15.1.1. Continuous Conduction Mode.

FET on, increasing current:
$$t_1 = \frac{1}{2 \cdot f_{switch}} \cdot \frac{V_{out} + V_f}{V_{in} \cdot \frac{n_p}{n_s}}$$

FET off, decreasing current:
$$t_2 = \frac{1}{2 \cdot f_{switch}} - t_1$$

Average Input Pulse Current:
$$I_{in,pulse,avg} = \frac{(V_{out} + V_f) \cdot I_{out}}{V_{in}} \cdot \frac{1}{2 \cdot D}$$

Min. Primary Current:
$$I_{pri,min} = I_{in,pulse,avg} - \frac{I_{ripple}}{2}$$

Max. Primary Current:
$$I_{pri,max} = I_{in,pulse,avg} + \frac{I_{ripple}}{2}$$

15.2. Primary Side Flyback Inductor N_p

15.2.1. CCM.

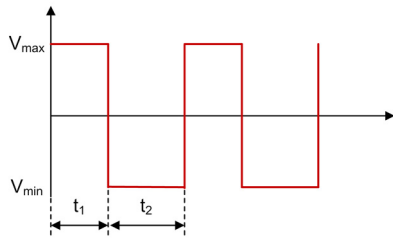

Figure 15.2.1. Weinberg - Primary Side Flyback Inductor N_p Voltage Waveform in CCM

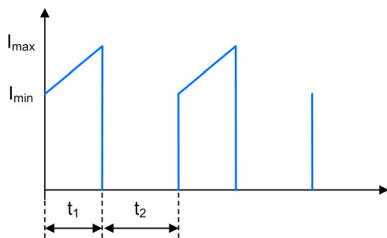

Figure 15.2.2. Weinberg - Primary Side Flyback Inductor N_p Current Waveform in CCM

Average Primary Flyback Inductor Current:
$$I_{N_p,avg} = \frac{I_{pri,min} + I_{pri,max}}{2} \cdot t_1 \cdot 2 \cdot f_{switch}$$

Min. Primary Flyback Inductor Current:
$$I_{N_p,min} = I_{pri,min}$$

Max. Primary Flyback Inductor Current:
$$I_{N_p,max} = I_{pri,max}$$

Min. Primary Flyback Inductor Voltage:
$$V_{N_p,min} = -(V_{out} + V_f) \cdot \frac{n_p}{n_s}$$

Max. Primary Flyback Inductor Voltage:
$$V_{N_p,i,max} = V_{in} - (V_{out} + V_f) \cdot \frac{n_p}{n_s}$$

15.3. Secondary Side Flyback Inductor N_s

15.3.1. CCM.

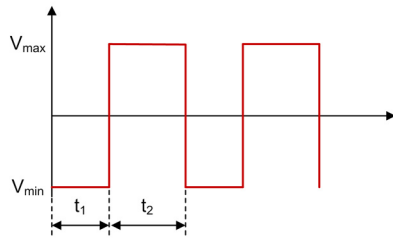

Figure 15.3.1. Weinberg - Secondary Side Flyback Inductor N_s Voltage Waveform in CCM

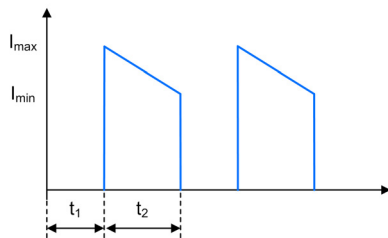

Figure 15.3.2. Weinberg - Secondary Side Flyback Inductor N_s Current Waveform in CCM

Min. Secondary Flyback Transformer Current:	$I_{N_s,min} = I_{pri,min} \cdot \frac{n_p}{n_s}$
Max. Secondary Flyback Transformer Current:	$I_{N_s,max} = I_{pri,max} \cdot \frac{n_p}{n_s}$
Average Secondary Flyback Transformer Current:	$I_{N_s,avg} = \frac{I_{N_s,min} + I_{N_s,max}}{2} \cdot t_2 \cdot 2 \cdot f_{switch}$
Min. Secondary Flyback Transformer Voltage:	$V_{N_s,min} = -V_{N_p,max} \cdot \frac{n_s}{n_p}$
Max. Secondary Flyback Transformer Voltage:	$V_{N_s,max} = -V_{N_p,min} \cdot \frac{n_s}{n_p}$

15.4. Primary Side Push-Pull Transformer Windings N_{p1} & N_{p2}

15.4.1. CCM.

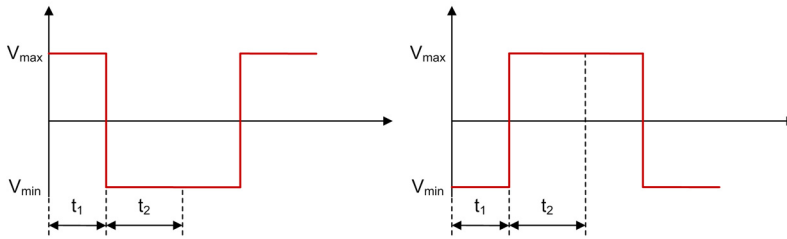

Figure 15.4.1. Weinberg - Primary Side Push-Pull Transformer Windings N_{p1} and N_{p2} Voltage Waveforms in CCM

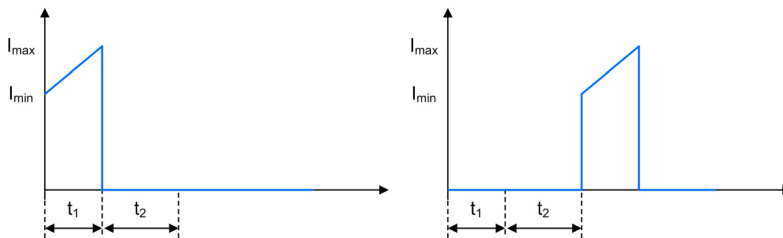

Figure 15.4.2. Weinberg - Primary Side Push-Pull Transformer Windings N_{p1} and N_{p2} Current Waveforms in CCM

Average Primary Push-Pull Transformer Current:
$$I_{N_{p1/p2},avg} = \frac{I_{pri,min} + I_{pri,max}}{2} \cdot t_1 \cdot f_{switch}$$

Min. Primary Push-Pull Transformer Current:
$$I_{N_{p1/p2},min} = I_{pri,min}$$

Max. Primary Push-Pull Transformer Current:
$$I_{N_{p1/p2},max} = I_{pri,max}$$

Min. Primary Push-Pull Transformer Voltage:
$$V_{N_{p1/p2},min} = -(V_{out} + V_f) \cdot \frac{n_p}{n_s}$$

Max. Primary Push-Pull Transformer Voltage:
$$V_{N_{p1/p2},max} = (V_{out} + V_f) \cdot \frac{n_p}{n_s}$$

15.5. Secondary Side Push-Pull Transformer Windings N_{s1} & N_{s2}

15.5.1. CCM.

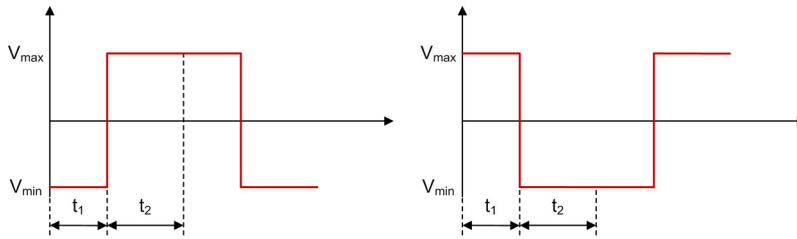

Figure 15.5.1. Weinberg - Secondary Side Push-Pull Transformer Windings N_{s1} and N_{s2} Voltage Waveforms in CCM

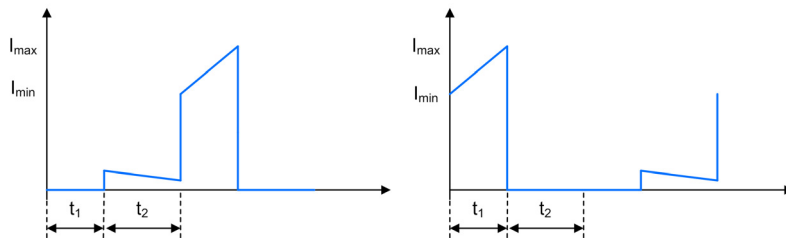

Figure 15.5.2. Weinberg - Secondary Side Push-Pull Transformer Windings N_{s1} and N_{s2} Current Waveforms in CCM

Min. Secondary Push-Pull Transformer Current during t_1 :
$$I_{N_{s1/s2},min,t_1} = (I_{pri,min} + \frac{(1-D) \cdot I_{mag}}{2}) \cdot \frac{n_p}{n_s}$$

Max. Secondary Push-Pull Transformer Current during t_1 :
$$I_{N_{s1/s2},max,t_1} = (I_{pri,min} - \frac{(1+D) \cdot I_{mag}}{2}) \cdot \frac{n_p}{n_s}$$

Min. Secondary Push-Pull Transformer Current during t_2 :
$$I_{N_{s1/s2},min,t_2} = I_{N_{s1/s2},min,t_1} - I_{N_s,min}$$

Max. Secondary Push-Pull Transformer Current during t_2 :
$$I_{N_{s1/s2},max,t_2} = I_{N_{s1/s2},max,t_1} - I_{N_s,min}$$

Average Secondary Push-Pull Transformer Current:

$$I_{N_{s1/s2},avg} = \frac{I_{N_{s1/s2},min,t_1} + I_{N_{s1/s2},max,t_1}}{2} \cdot t_1 \cdot f_{switch} + \frac{I_{N_{s1/s2},min,t_2} + I_{N_{s1/s2},max,t_2}}{2} \cdot t_2 \cdot f_{switch}$$

Min. Secondary Push-Pull Transformer Voltage:
$$V_{N_{s1/s2},min} = V_{N_{p1/p2},min} \cdot \frac{n_s}{n_p}$$

Max. Secondary Push-Pull Transformer Voltage:
$$V_{N_{s1/s2},max} = V_{N_{p1/p2},max} \cdot \frac{n_s}{n_p}$$

15.6. FET Q_1 & Q_2

15.6.1. CCM.

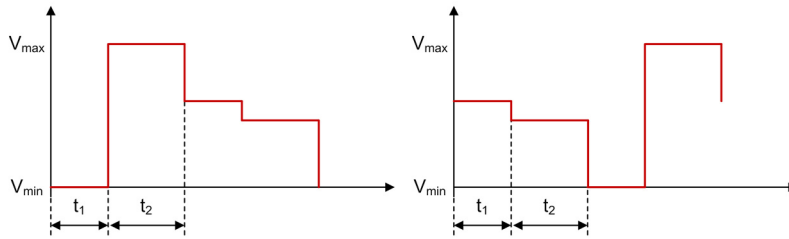

Figure 15.6.1. Weinberg - FET Q_1 and Q_2 Voltage Waveforms in CCM

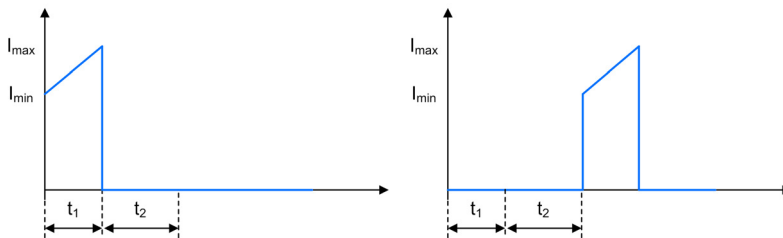

Figure 15.6.2. Weinberg - FET Q_1 and Q_2 Current Waveforms in CCM

Average FET Current:	$I_{Q_{1/2},avg} = I_{N_p,avg}$
Min. FET Current:	$I_{Q_{1/2},min} = I_{pri,min}$
Max. FET Current:	$I_{Q_{1/2},max} = I_{pri,max}$
Min. FET Voltage:	$V_{Q_{1/2},min} = 0V$
FET Voltage (t_2 of other FET):	$V_{Q_{1/2},otheroff} = V_{in}$
FET Voltage (t_1 of other FET):	$V_{Q_{1/2},otheron} = 2 \cdot \frac{n_p}{n_s} \cdot (V_{out} + V_f)$
Max. FET Voltage (t_2 of FET):	$V_{Q_{1/2},max} = V_{in} + 2 \cdot \frac{n_p}{n_s} \cdot (V_{out} + V_f)$

15.7. Push-Pull Rectifier Diodes D_1 & D_2

15.7.1. CCM.

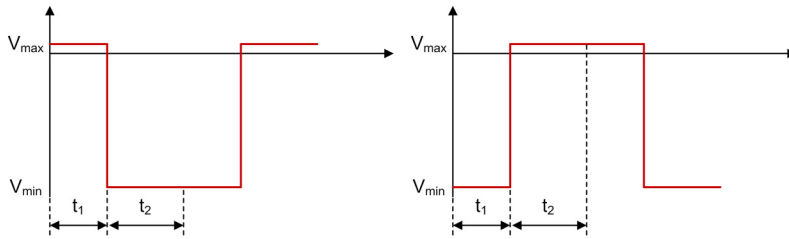

Figure 15.7.1. Weinberg - Push-Pull Rectifier Diodes D_1 and D_2 Voltage Waveforms in CCM

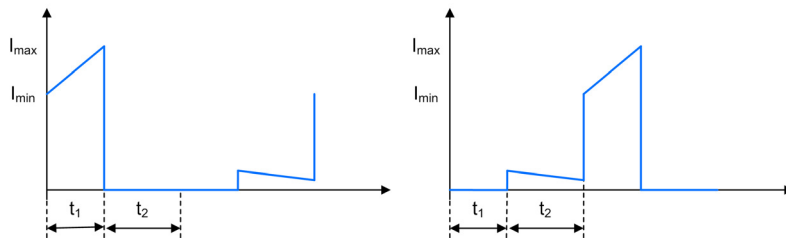

Figure 15.7.2. Weinberg - Push-Pull Rectifier Diodes D_1 and D_2 Current Waveforms in CCM

Average Rectifier Diode Current: $I_{D_{1/2},avg} = I_{pushpull,sec,avg}$

Min. Rectifier Diode Current during t_1 : $I_{D_{1/2},min,t_1} = I_{N_{s1/s2},min,t_1}$

Max. Rectifier Diode Current during t_1 : $I_{D_{1/2},max,t_1} = I_{N_{s1/s2},max,t_1}$

Min. Rectifier Diode Current during t_2 : $I_{D_{1/2},min,t_2} = I_{N_{s1/s2},min,t_2}$

Max. Rectifier Diode Current during t_2 : $I_{D_{1/2},max,t_2} = I_{N_{s1/s2},max,t_2}$

Min. Rectifier Diode Voltage: $V_{D_{1/2},min} = 2 \cdot V_{N_{p1/p2},min} \cdot \frac{n_s}{n_p}$

Max. Rectifier Diode Voltage: $V_{D_{1/2},max} = V_f$

15.8. Flyback Demagnetization Diode D_3

15.8.1. CCM.

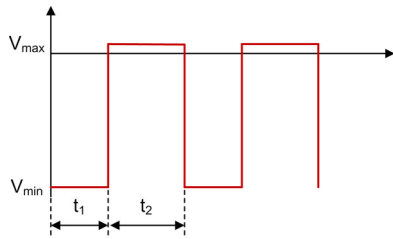

Figure 15.8.1. Weinberg - Flyback Demagnetization Diode D_3 Voltage Waveform in CCM

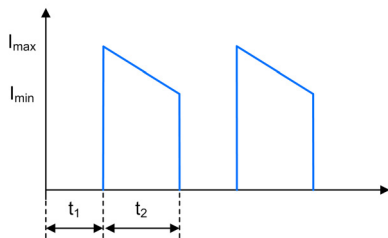

Figure 15.8.2. Weinberg - Flyback Demagnetization Diode D_3 Current Waveform in CCM

Average Demagnetization Diode Current: $I_{D3,avg} = I_{N_s,avg}$

Demagnetization Diode Current during t_1 : $I_{D3,t1} = 0A$

Min. Demagnetization Diode Current during t_2 : $I_{D3,min,t2} = I_{N_s,min}$

Max. Demagnetization Diode Current during t_2 : $I_{D3,max,t2} = I_{N_s,max}$

Min. Demagnetization Diode Voltage: $V_{D3,min} = V_{N_s,min} - V_{out}$

Max. Demagnetization Diode Voltage: $V_{D3,max} = V_f$

15.9. Input Capacitor C_i

15.9.1. CCM.

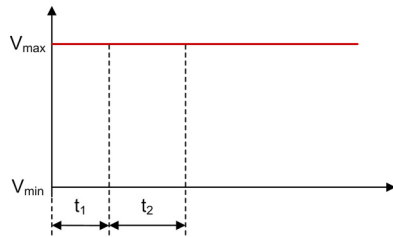

Figure 15.9.1. Weinberg - Input Capacitor C_i Voltage Waveform in CCM

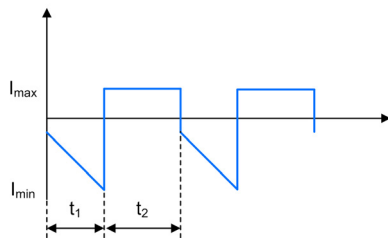

Figure 15.9.2. Weinberg - Input Capacitor C_i Current Waveform in CCM

Min. Input Capacitor Current during t_1 : $I_{C_i, min, t_1} = I_{N_p, avg} - I_{N_{p1/p2}, max}$

Max. Input Capacitor Current during t_1 : $I_{C_i, max, t_1} = I_{N_p, avg} - I_{N_{p1/p2}, min}$

Input Capacitor Current during t_2 : $I_{C_i, t_2} = I_{N_p, avg}$

Average Input Capacitor Current: $I_{C_i, avg} = 0A$

Input Capacitor Voltage: $V_{C_i} = V_{in}$

15.10. Output Capacitor C_o

15.10.1. CCM.

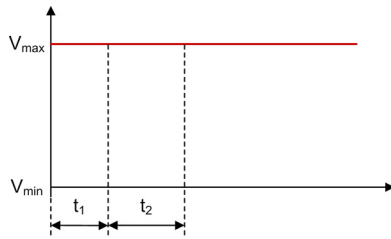

Figure 15.10.1. Weinberg - Output Capacitor C_o Voltage Waveform in CCM

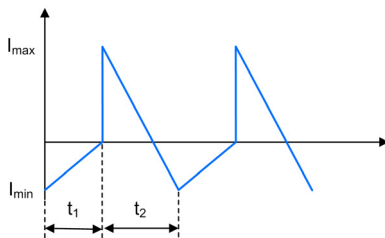

Figure 15.10.2. Weinberg - Output Capacitor C_o Current Waveform in CCM

Min. Output Capacitor Current during t_1 : $I_{C_o,min,t_1} = I_{D_{1/2},min,t_1} - I_{out}$

Max. Output Capacitor Current during t_1 : $I_{C_o,max,t_1} = I_{D_{1/2},max,t_1} - I_{out}$

Min. Output Capacitor Current during t_2 : $I_{C_o,min,t_2} = I_{D_3,min,t_2} + I_{D_{1/2},min,t_2} - I_{out}$

Max. Output Capacitor Current during t_2 : $I_{C_o,max,t_2} = I_{D_3,max,t_2} + I_{D_{1/2},max,t_2} - I_{out}$

Average Output Capacitor Current: $I_{C_o,avg} = 0A$

Output Capacitor Voltage: $V_{C_o} = V_{out}$

Half-Bridge Converter

A Half-Bridge regulator converts an input voltage to a higher or lower, positive or negative output voltage level. The energy is transferred to the output when the FETs are conducting.

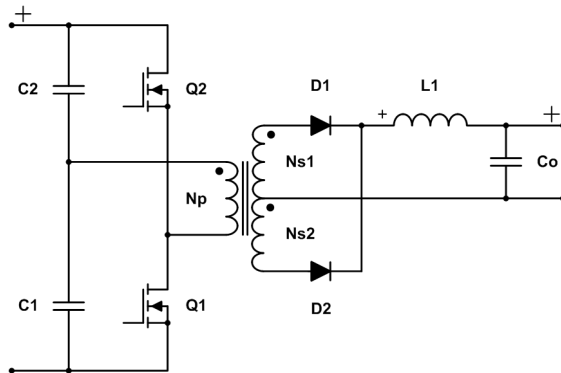

Figure 16.0.1. Schematic of a Half-Bridge converter

15.1. General

Secondary Side Inductance:
$$L_s = \frac{L_p}{\left(\frac{n_p}{n_s}\right)^2}$$

Inductor Current Ripple:
$$I_{ripple} = \frac{1}{L_1} \cdot \left(\frac{1}{2} \cdot V_{in} \cdot \frac{n_s}{n_p} - V_f - V_{out}\right) \cdot t_1$$

Magnetization Current:
$$I_{mag} = \frac{1}{2} \cdot \frac{V_{in} \cdot t_1}{L_p}$$

16.1.1. Continuous Conduction Mode.

$$\begin{aligned} \text{FET on, increasing current:} \quad t_1 &= \frac{1}{f_{\text{switch}}} \cdot \frac{V_{\text{out}} + V_f}{V_{\text{in}} \cdot \frac{n_s}{n_p}} \\ \text{FET off, decreasing current:} \quad t_2 &= \frac{1}{2 \cdot f_{\text{switch}}} - t_1 \\ \text{Min. Secondary Current:} \quad I_{\text{sec,min}} &= I_{\text{out}} - \frac{1}{2} \cdot I_{\text{ripple}} \\ \text{Max. Secondary Current:} \quad I_{\text{sec,max}} &= I_{\text{out}} + \frac{1}{2} \cdot I_{\text{ripple}} \\ \text{Min. Primary Current:} \quad I_{\text{pri,min}} &= I_{\text{sec,min}} \cdot \frac{n_s}{n_p} - \frac{1}{2} \cdot I_{\text{mag}} \\ \text{Max. Primary Current:} \quad I_{\text{pri,max}} &= I_{\text{sec,max}} \cdot \frac{n_s}{n_p} + \frac{1}{2} \cdot I_{\text{mag}} \\ \text{Average Input Current:} \quad I_{\text{in,avg}} &= \frac{(V_{\text{out}} + V_f) \cdot I_{\text{out}}}{V_{\text{in}}} \end{aligned}$$

16.1.2. Discontinuous Conduction Mode.

$$\begin{aligned} \text{FET on, increasing current:} \quad t_1 &= \sqrt{2 \cdot I_{\text{out}} \cdot L_1 \cdot \frac{V_{\text{out}} + V_f}{2 \cdot f_{\text{switch}} \cdot \left(\frac{1}{2} \cdot V_{\text{in}} \cdot \frac{n_s}{n_p} - V_f - V_{\text{out}} \right) \cdot \left(\frac{1}{2} \cdot V_{\text{in}} \cdot \frac{n_s}{n_p} \right)}} \\ \text{FET off, decreasing current:} \quad t_2 &= t_1 \cdot \frac{\frac{1}{2} \cdot V_{\text{in}} \cdot \frac{n_s}{n_p}}{(V_{\text{out}} + V_f)} - t_1 \\ \text{FET off, demagnetization:} \quad t_3 &= \frac{1}{2 \cdot f_{\text{switch}}} - t_1 - t_2 \\ \text{Min. Secondary Current:} \quad I_{\text{sec,min}} &= 0A \\ \text{Max. Secondary Current:} \quad I_{\text{sec,max}} &= I_{\text{ripple}} \\ \text{Min. Primary Current:} \quad I_{\text{pri,max}} &= 0A \\ \text{Max. Primary Current:} \quad I_{\text{pri,max}} &= I_{\text{sec,max}} \cdot \frac{n_s}{n_p} + \frac{1}{2} \cdot I_{\text{mag}} \\ \text{Average Input Current:} \quad I_{\text{in,avg}} &= \frac{(V_{\text{out}} + V_f) \cdot I_{\text{out}}}{V_{\text{in}}} \end{aligned}$$

16.2. Primary Side Transformer Winding N_p

16.2.1. CCM & DCM.

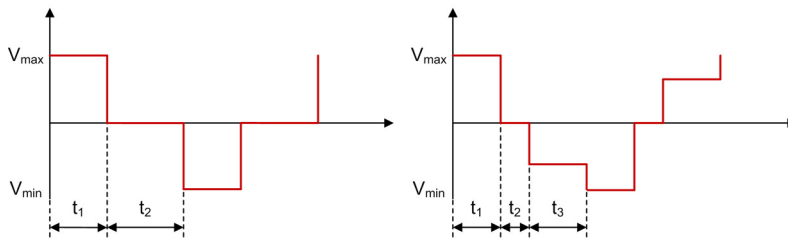

Figure 16.2.1. Half-Bridge - Primary Side Transformer Winding N_p Voltage Waveforms in CCM and DCM

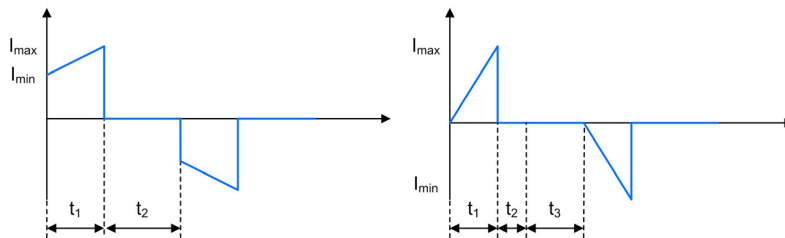

Figure 16.2.2. Half-Bridge - Primary Side Transformer Winding N_p Current Waveforms in CCM and DCM

Average Primary Transformer Current:	$I_{N_p,avg} = 0A$
Min. Primary Transformer Current:	$I_{N_p,min} = I_{pri,min}$
Max. Primary Transformer Current:	$I_{N_p,max} = I_{pri,max}$
Min. Primary Transformer Voltage:	$V_{N_p,min} = -\frac{1}{2} \cdot V_{in}$
Max. Primary Transformer Voltage:	$V_{N_p,max} = \frac{1}{2} \cdot V_{in}$
Min. Primary Transformer Voltage during t_3 :	$V_{N_p,t_3} = (V_{out} + V_f) \cdot \frac{n_p}{n_s}$

16.3. Secondary Side Transformer Winding N_{s1} & N_{s2}

16.3.1. CCM & DCM.

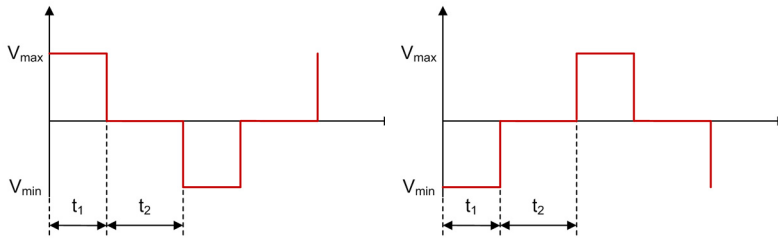

Figure 16.3.1. Half-Bridge - Secondary Side Transformer Windings N_{s1} and N_{s2} Voltage Waveforms in CCM

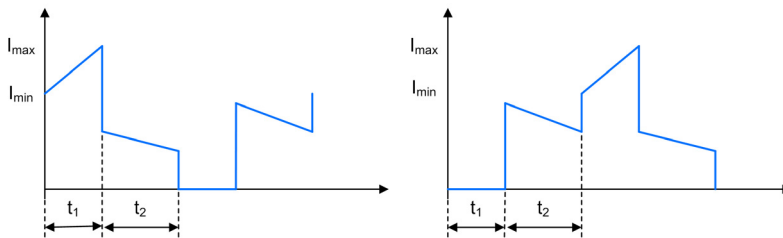

Figure 16.3.2. Half-Bridge - Secondary Side Transformer Windings N_{s1} and N_{s2} Current Waveforms in CCM

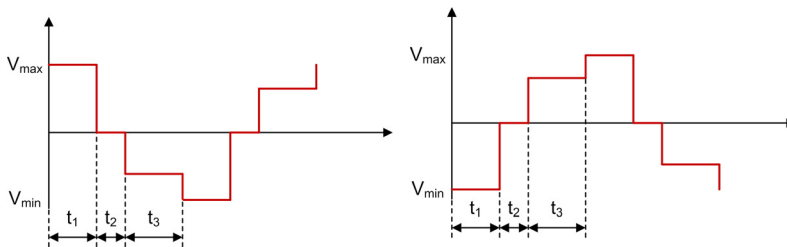

Figure 16.3.3. Half-Bridge - Secondary Side Transformer Windings N_{s1} and N_{s2} Voltage Waveforms in DCM

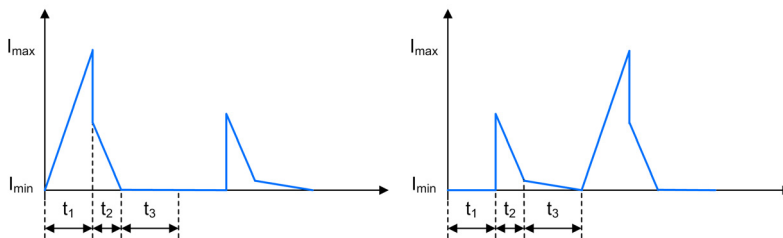

Figure 16.3.4. Half-Bridge - Secondary Side Transformer Windings N_{s1} and N_{s2} Current Waveforms in DCM

Min. Secondary Current (t_1 of FET):	$I_{N_{s1/s2},min,t_1} = I_{sec,min}$
Max. Secondary Current (t_1 of FET):	$I_{N_{s1/s2},max,t_1} = I_{sec,max}$
Min. Secondary Current (t_2 of other FET):	$I_{N_{s1/s2},min,t_2,other} = \frac{I_{pri,max}}{2 \cdot \frac{n_s}{n_p}} - \frac{I_{ripple}}{2}$
Max. Secondary Current (t_2 of other FET):	$I_{N_{s1/s2},max,t_2,other} = \frac{I_{pri,max}}{2 \cdot \frac{n_s}{n_p}}$
Min. Secondary Current (t_2 of FET, CCM):	$I_{N_{s1/s2},min,t_2} = I_{sec,min} - I_{N_{s1/s2},min,t_2,other}$
Min. Secondary Current (t_2 of FET, DCM):	$I_{N_{s1/s2},min,t_2} = 0A$
Max. Secondary Current (t_2 of FET):	$I_{N_{s1/s2},max,t_2} = I_{sec,max} - I_{N_{s1/s2},max,t_2,other}$
Min. Secondary Current (t_3 of other FET):	$I_{N_{s1/s2},min,t_3,other} = 0A$
Max. Secondary Current (t_3 of other FET):	$I_{N_{s1/s2},max,t_3,other} = I_{N_{s1/s2},max,t_2,other} - I_{N_{s1/s2},max,t_2}$
Secondary Current (t_3 of FET):	$I_{N_{s1/s2},t_3} = 0A$
Average Secondary Current:	
	$I_{N_{s1/s2},avg} = f_{switch} \cdot \left(\frac{I_{sec,min} + I_{sec,max}}{2} \cdot t_1 + \frac{I_{N_{s1/s2},max,t_2} + I_{N_{s1/s2},min,t_2,other}}{2} \cdot t_2 + \frac{I_{N_{s1/s2},min,t_2} + I_{N_{s1/s2},max,t_2,other}}{2} \cdot t_2 \right)$
Min. Secondary Voltage:	$V_{N_{s1/s2},min} = -\frac{1}{2} \cdot V_{in} \cdot \frac{n_s}{n_p}$
Max. Secondary Voltage:	$V_{N_{s1/s2},max} = \frac{1}{2} \cdot V_{in} \cdot \frac{n_s}{n_p}$
Secondary Voltage during t_3 :	$V_{N_{s1/s2},max,t_3} = V_{out} + V_f$

16.4. Inductor L_1

16.4.1. CCM & DCM.

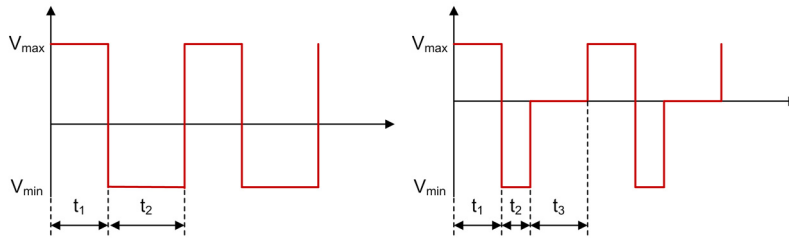

Figure 16.4.1. Half-Bridge - Inductor L_1 Voltage Waveforms in CCM and DCM

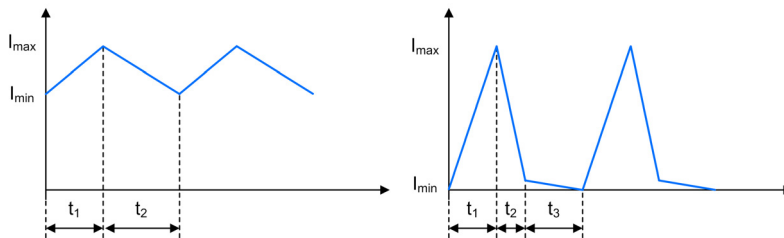

Figure 16.4.2. Half-Bridge - Inductor L_1 Current Waveforms in CCM and DCM

Average Inductor Current:	$I_{L1,avg} = \frac{I_{sec,max} + I_{sec,min}}{2}$
Min. Inductor Current:	$I_{L1,min} = I_{sec,min}$
Max. Inductor Current:	$I_{L1,max} = I_{sec,max}$
Min. Inductor Current during t_3 :	$I_{L1,min,t3} = I_{N_{s1/s2},min,t3}$
Max. Inductor Current during t_3 :	$I_{L1,max,t3} = I_{N_{s1/s2},max,t3}$
Min. Inductor Voltage:	$V_{L1,min} = -V_{out} - V_f$
Max. Inductor Voltage:	$V_{L1,max} = \frac{1}{2} \cdot V_{in} \cdot \frac{n_s}{n_p} - V_f - V_{out}$
Inductor Voltage during t_3 :	$V_{L1,t3} = 0V$

16.5. FET Q_1 & Q_2

16.5.1. CCM & DCM.

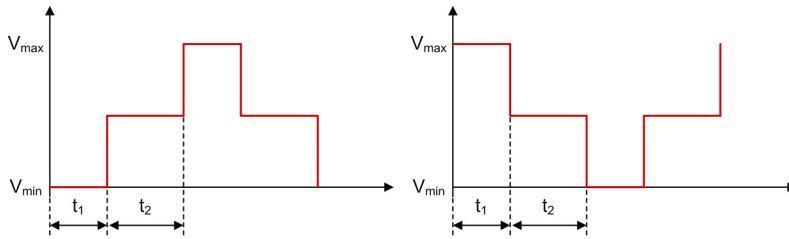

Figure 16.5.1. Half-Bridge - FETs Q_1 and Q_2 Voltage Waveforms in CCM

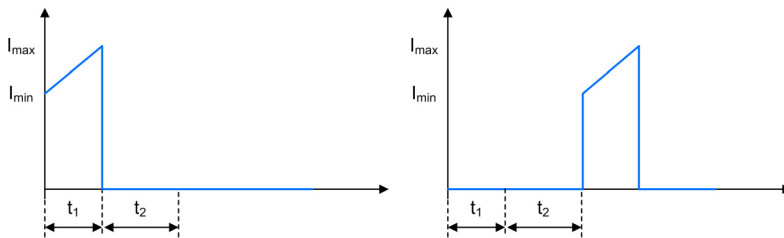

Figure 16.5.2. Half-Bridge - FETs Q_1 and Q_2 Current Waveforms in CCM

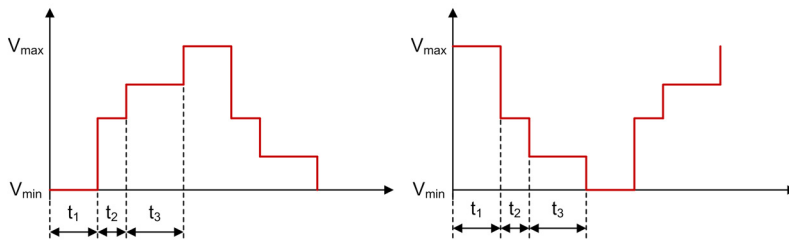

Figure 16.5.3. Half-Bridge - FETs Q_1 and Q_2 Voltage Waveforms in DCM

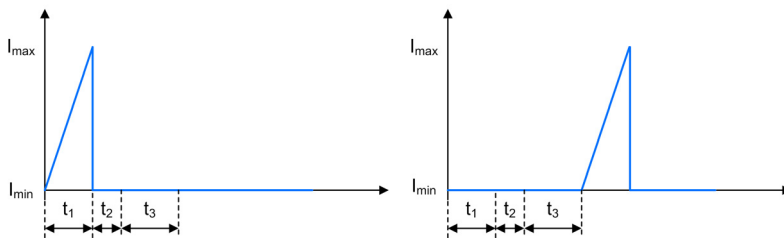

Figure 16.5.4. Half-Bridge - FETs Q_1 and Q_2 Current Waveforms in DCM

Average FET Current: $I_{Q_{1/2},avg} = \frac{I_{pri,min} + I_{pri,max}}{2} \cdot t_1 \cdot f_{switch}$

Min. FET Current: $I_{Q_{1/2},min} = I_{pri,min}$

Max. FET Current: $I_{Q_{1/2},max} = I_{pri,max}$

Min. FET Voltage during t_1 : $V_{Q_{1/2},min,t_1} = 0V$

Max. FET Voltage during t_1 : $V_{Q_{1/2},max,t_1} = V_{in}$

FET Voltage during t_2 : $V_{Q_{1/2},t_2} = \frac{1}{2} \cdot V_{in}$

Min. FET Voltage during t_3 : $V_{Q_{1/2},min,t_3} = \frac{V_{in}}{2} - (V_{out} + V_f) \cdot \frac{n_p}{n_s}$

Max. FET Voltage during t_3 : $V_{Q_{1/2},max,t_3} = \frac{V_{in}}{2} + (V_{out} + V_f) \cdot \frac{n_p}{n_s}$

16.6. Rectifier Diode D_1 & D_2

16.6.1. CCM & DCM.

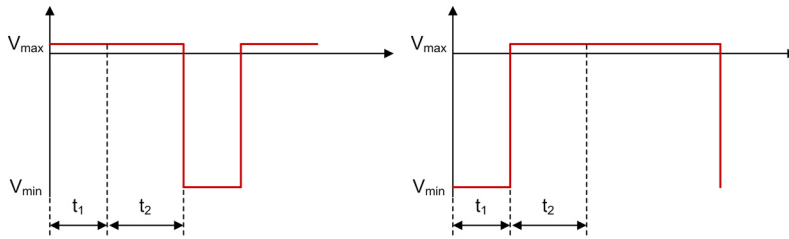

Figure 16.6.1. Half-Bridge - Rectifier Diodes D_1 and D_2 Voltage Waveforms in CCM

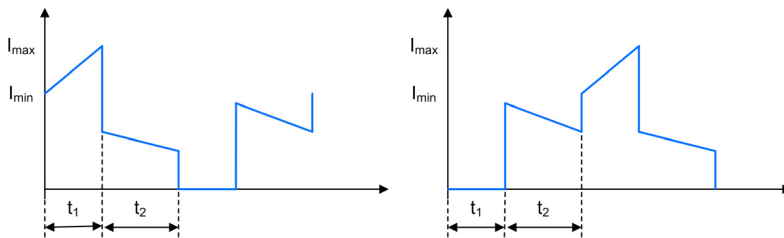

Figure 16.6.2. Half-Bridge - Rectifier Diodes D_1 and D_2 Current Waveforms in CCM

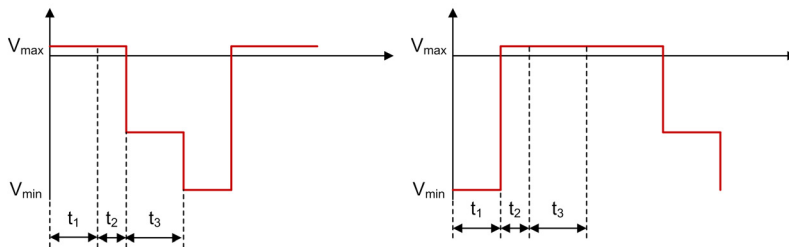

Figure 16.6.3. Half-Bridge - Rectifier Diodes D_1 and D_2 Voltage Waveforms in DCM

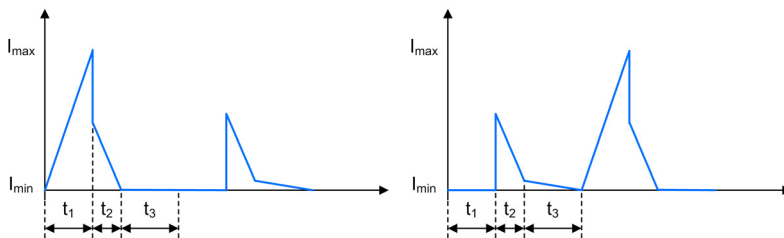

Figure 16.6.4. Half-Bridge - Rectifier Diodes D_1 and D_2 Current Waveforms in DCM

Average Rectifier Diode Current:	$I_{D_{1/2},avg} = I_{N_{s1/s2},avg}$
Min. Rectifier Diode Current (t_1 of FET):	$I_{D_{1/2},min} = I_{N_{s1/s2},min}$
Max. Rectifier Diode Current (t_1 of FET):	$I_{D_{1/2},max} = I_{N_{s1/s2},max}$
Min. Rectifier Diode Current (t_2 of other FET):	$I_{D_{1/2},min,t_2,other} = I_{N_{s1/s2},min,t_2,other}$
Max. Rectifier Diode Current (t_2 of other FET):	$I_{D_{1/2},max,t_2,other} = I_{N_{s1/s2},max,t_2,other}$
Min. Rectifier Diode Current (t_2 of FET):	$I_{D_{1/2},min,t_2} = I_{N_{s1/s2},min,t_2}$
Max. Rectifier Diode Current (t_2 of FET):	$I_{D_{1/2},max,t_2} = I_{N_{s1/s2},max,t_2}$
Min. Rectifier Diode Current (t_3 of other FET):	$I_{D_{1/2},min,t_3,other} = I_{N_{s1/s2},min,t_3,other}$
Max. Rectifier Diode Current (t_3 of other FET):	$I_{D_{1/2},max,t_3,other} = I_{N_{s1/s2},max,t_3,other}$
Rectifier Diode Current (t_3 of FET):	$I_{D_{1/2},t_3} = 0A$
Min. Rectifier Diode Voltage:	$V_{D_{1/2},min} = -V_{in} \cdot \frac{n_s}{n_p} + V_f$
Max. Rectifier Diode Voltage:	$V_{D_{1/2},max} = V_f$
Rectifier Diode Voltage during t_3 :	$V_{D_{1/2},t_3} = -V_{in} \cdot \frac{n_p}{n_s}$

16.7. Input Capacitor C_1 & C_2

16.7.1. CCM & DCM.

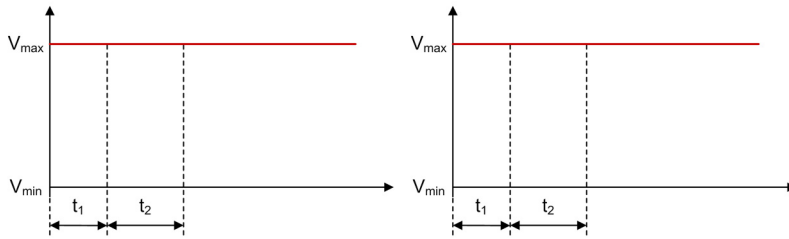

Figure 16.7.1. Half-Bridge - Input Capacitor C_1 and C_2 Voltage Waveforms in CCM

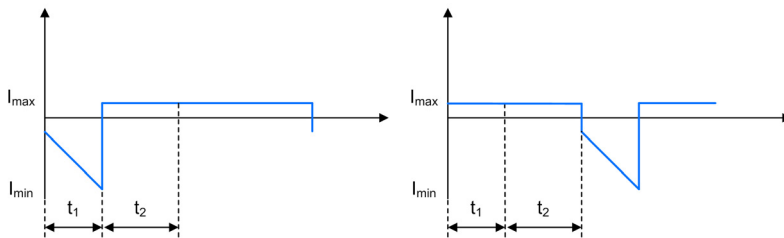

Figure 16.7.2. Half-Bridge - Input Capacitor C_1 and C_2 Current Waveforms in CCM

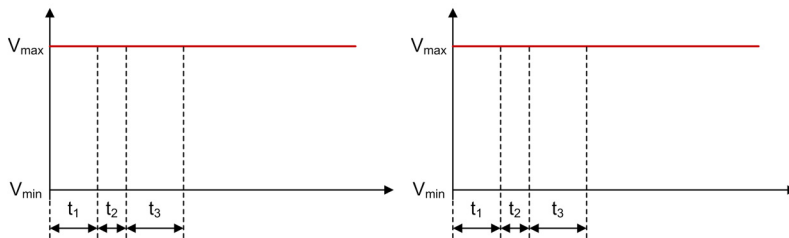

Figure 16.7.3. Half-Bridge - Input Capacitor C_1 and C_2 Voltage Waveforms in DCM

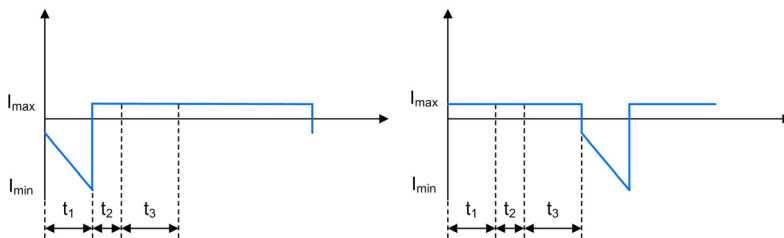

Figure 16.7.4. Half-Bridge - Input Capacitor C_1 and C_2 Current Waveforms in DCM

Min. Input Capacitor Current during t_1 : $I_{C_{1/2},min,t_1} = I_{Q_{1/2},avg} - I_{N_p,max}$

Max. Input Capacitor Current during t_1 : $I_{C_{1/2},max,t_1} = I_{Q_{1/2},avg} - I_{N_p,min}$

Input Capacitor Current during t_2 and t_3 : $I_{C_{1/2},t_2/t_3} = I_{Q_{1/2},avg}$

Average Input Capacitor Current: $I_{C_{1/2},avg} = 0A$

Input Capacitor Voltage: $V_{C_{1/2}} = \frac{V_{in}}{2}$

16.8. Output Capacitor C_o

16.8.1. CCM & DCM.

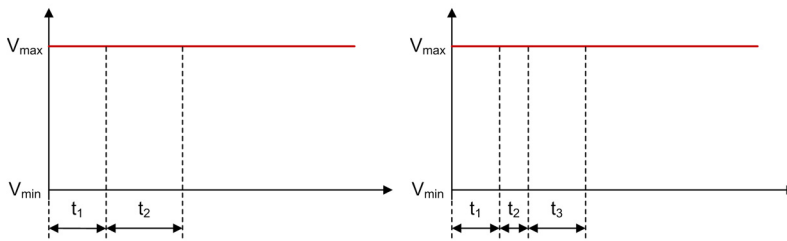

Figure 16.8.1. Half-Bridge - Output Capacitor C_o Voltage Waveforms in CCM and DCM

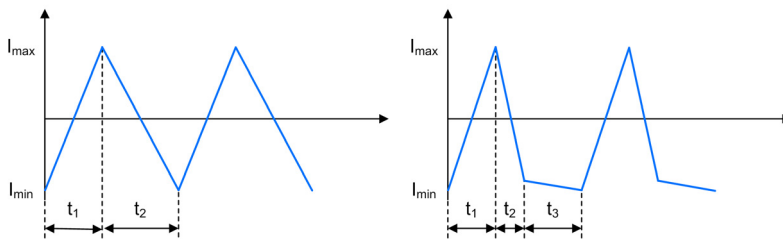

Figure 16.8.2. Half-Bridge - Output Capacitor C_o Current Waveforms in CCM and DCM

Min. Output Capacitor Current: $I_{C_o,min} = I_{sec,min} - I_{out}$

Max. Output Capacitor Current: $I_{C_o,max} = I_{sec,max} - I_{out}$

Min. Output Capacitor Current during t_3 : $I_{C_o,min,t_3} = I_{sec,min} - I_{out}$

Max. Output Capacitor Current during t_3 : $I_{C_o,max,t_3} = I_{N_{1/2},max,t_3} - I_{out}$

Average Output Capacitor Current: $I_{C_o,avg} = 0A$

Output Capacitor Voltage: $V_{C_o} = V_{out}$

Full-Bridge Converter

A Full-Bridge regulator converts an input voltage to a higher or lower, positive or negative output voltage level. The energy is transferred to the output when the FETs are conducting.

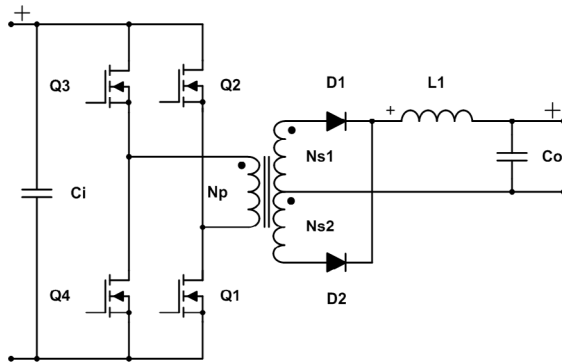

Figure 17.0.1. Schematic of a Full-Bridge converter

17.1. General

Secondary Side Inductance:
$$L_s = \frac{L_p}{\left(\frac{n_p}{n_s}\right)^2}$$

Inductor Current Ripple:
$$I_{ripple} = \frac{1}{L_1} \cdot \left(V_{in} \cdot \frac{n_s}{n_p} - V_f - V_{out} \right) \cdot t_1$$

Magnetization Current:
$$I_{mag} = \frac{V_{in} \cdot t_1}{L_p}$$

17.1.1. Continuous Conduction Mode.

$$\begin{aligned} \text{FETs on, increasing current:} \quad t_1 &= \frac{1}{2 \cdot f_{switch}} \cdot \frac{V_{out} + V_f}{V_{in} \cdot \frac{n_s}{n_p}} \\ \text{FETs off, decreasing current:} \quad t_2 &= \frac{1}{2 \cdot f_{switch}} - t_1 \\ \text{Min. Secondary Current:} \quad I_{sec,min} &= I_{out} - \frac{1}{2} \cdot I_{ripple} \\ \text{Max. Secondary Current:} \quad I_{sec,max} &= I_{out} + \frac{1}{2} \cdot I_{ripple} \\ \text{Min. Primary Current:} \quad I_{pri,min} &= I_{sec,min} \cdot \frac{n_s}{n_p} - \frac{1}{2} \cdot I_{mag} \\ \text{Max. Primary Current:} \quad I_{pri,max} &= I_{sec,max} \cdot \frac{n_s}{n_p} + \frac{1}{2} \cdot I_{mag} \\ \text{Average Input Current:} \quad I_{in,avg} &= \frac{(V_{out} + V_f) \cdot I_{out}}{V_{in}} \end{aligned}$$

17.1.2. Discontinuous Conduction Mode.

$$\begin{aligned} \text{FETs on, increasing current:} \quad t_1 &= \sqrt{2 \cdot I_{out} \cdot L_1 \cdot \frac{V_{out} + V_f}{2 \cdot f_{switch} \cdot (V_{in} \cdot \frac{n_s}{n_p} - V_f - V_{out}) \cdot (V_{in} \cdot \frac{n_s}{n_p})}} \\ \text{FETs off, decreasing current:} \quad t_2 &= t_1 \cdot \frac{V_{in} \cdot \frac{n_s}{n_p}}{(V_{out} + V_f)} - t_1 \\ \text{FETs off, demagnetization:} \quad t_3 &= \frac{1}{2 \cdot f_{switch}} - t_1 - t_2 \\ \text{Min. Secondary Current:} \quad I_{sec,min} &= 0A \\ \text{Max. Secondary Current:} \quad I_{sec,max} &= I_{ripple} \\ \text{Min. Primary Current:} \quad I_{pri,max} &= 0A \\ \text{Max. Primary Current:} \quad I_{pri,max} &= I_{sec,max} \cdot \frac{n_s}{n_p} + \frac{1}{2} \cdot I_{mag} \\ \text{Average Input Current:} \quad I_{in,avg} &= \frac{(V_{out} + V_f) \cdot I_{out}}{V_{in}} \end{aligned}$$

17.2. Primary Side Transformer Winding N_p

17.2.1. CCM & DCM.

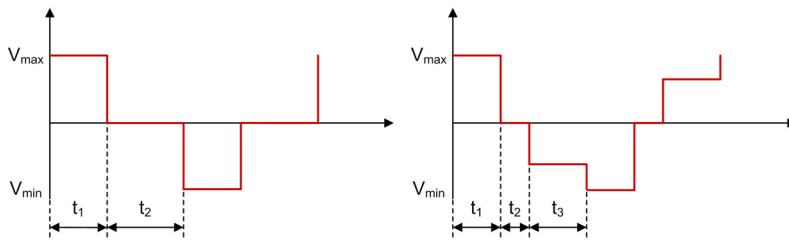

Figure 17.2.1. Full-Bridge - Primary Side Transformer Winding N_p Voltage Waveforms in CCM and DCM

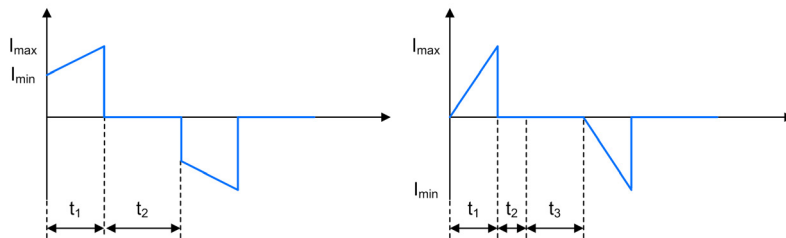

Figure 17.2.2. Full-Bridge - Primary Side Transformer Winding N_p Current Waveforms in CCM and DCM

Average Primary Transformer Current: $I_{N_p,avg} = 0A$

Min. Primary Transformer Current: $I_{N_p,min} = I_{pri,min}$

Max. Primary Transformer Current: $I_{N_p,max} = I_{pri,max}$

Min. Primary Transformer Voltage: $V_{N_p,min} = -V_{in}$

Max. Primary Transformer Voltage: $V_{N_p,max} = V_{in}$

Primary Transformer Voltage during t_3 : $V_{N_p,t_3} = (V_{out} + V_f) \cdot \frac{n_p}{n_s}$

17.3. Secondary Side Transformer Winding N_{s1} & N_{s2}

17.3.1. CCM & DCM.

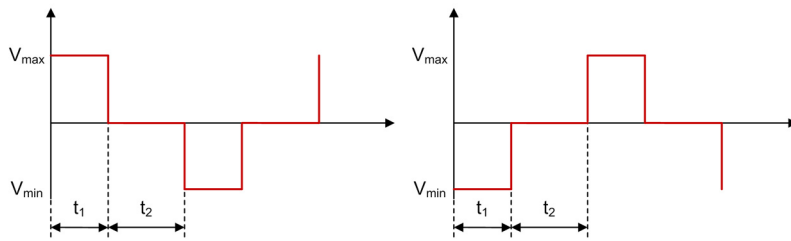

Figure 17.3.1. Full-Bridge - Secondary Side Transformer Windings N_{s1} and N_{s2} Voltage Waveforms in CCM

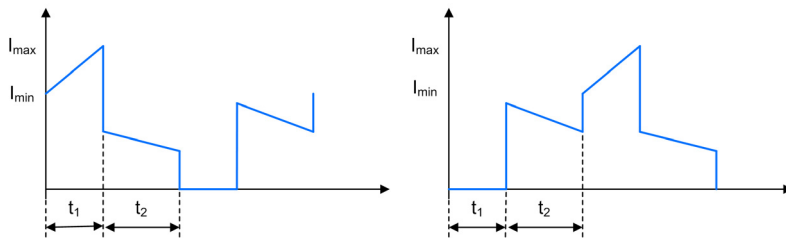

Figure 17.3.2. Full-Bridge - Secondary Side Transformer Windings N_{s1} and N_{s2} Current Waveforms in CCM

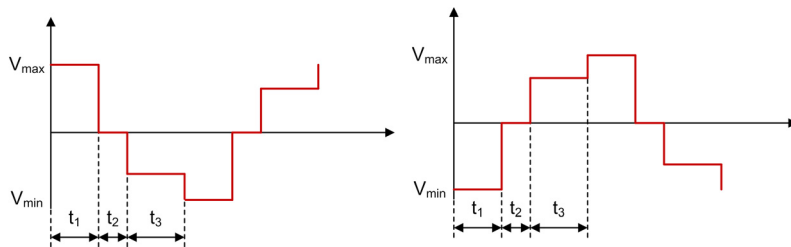

Figure 17.3.3. Full-Bridge - Secondary Side Transformer Windings N_{s1} and N_{s2} Voltage Waveforms in DCM

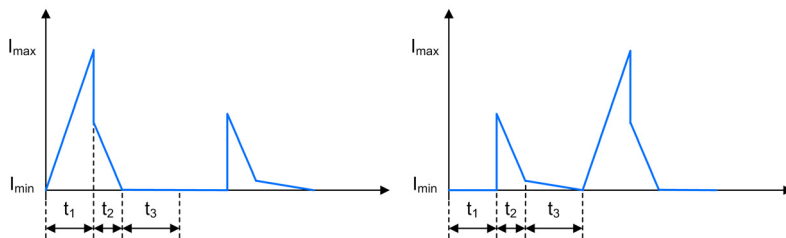

Figure 17.3.4. Full-Bridge - Secondary Side Transformer Windings N_{s1} and N_{s2} Current Waveforms in DCM

Min. Secondary Transformer Current (t_1 of FET):	$I_{N_{s1/s2},min} = I_{sec,min}$
Max. Secondary Transformer Current (t_2 of FET):	$I_{N_{s1/s2},max} = I_{sec,max}$
Min. Secondary Transformer Current (t_2 of other FET):	$I_{N_{s1/s2},min,t_2,other} = \frac{I_{pri,max}}{2 \cdot \frac{n_s}{n_p}} - \frac{I_{ripple}}{2}$
Max. Secondary Transformer Current (t_2 of other FET):	$I_{N_{s1/s2},max,t_2,other} = \frac{I_{pri,max}}{2 \cdot \frac{n_s}{n_p}}$
Min. Secondary Transformer Current (t_2 of FET, CCM):	$I_{N_{s1/s2},min,t_2} = I_{sec,min} - I_{N_{s1/s2},min,t_2,other}$
Min. Secondary Transformer Current (t_2 of FET, DCM):	$I_{N_{s1/s2},min,t_2} = 0A$
Max. Secondary Transformer Current (t_2 of FET):	$I_{N_{s1/s2},max,t_2} = I_{sec,max} - I_{N_{s1/s2},max,t_2,other}$
Min. Secondary Transformer Current (t_3 of other FET):	$I_{N_{s1/s2},min,t_3,other} = 0A$
Max. Secondary Transformer Current (t_3 of other FET):	$I_{N_{s1/s2},max,t_3,other} = I_{N_{s1/s2},max,t_2,other} - I_{trans,sec,max,t_2}$
Secondary Transformer Current (t_3 of FET):	$I_{N_{s1/s2},t_3} = 0A$
Average Secondary Current:	
	$I_{N_{s1/s2},avg} = f_{switch} \cdot \left(\frac{I_{sec,min} + I_{sec,max}}{2} \cdot t_1 + \frac{I_{N_{s1/s2},max,t_2} + I_{N_{s1/s2},min,t_2,other}}{2} \cdot t_2 + \frac{I_{N_{s1/s2},min,t_2} + I_{N_{s1/s2},max,t_2,other}}{2} \cdot t_2 \right)$
Min. Secondary Transformer Voltage:	$V_{N_{s1/s2},min} = -V_{in} \cdot \frac{n_s}{n_p}$
Max. Secondary Transformer Voltage:	$V_{N_{s1/s2},max} = V_{in} \cdot \frac{n_s}{n_p}$
Secondary Transformer Voltage during t_3 :	$V_{N_{s1/s2},max,t_3} = -V_{out} - V_f$

17.4. Inductor L_1

17.4.1. CCM & DCM.

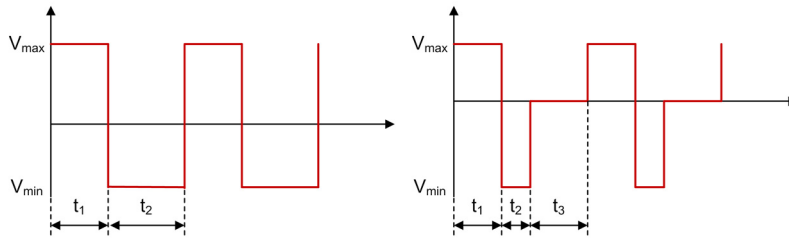

Figure 17.4.1. Full-Bridge - Inductor L_1 Voltage Waveforms in CCM and DCM

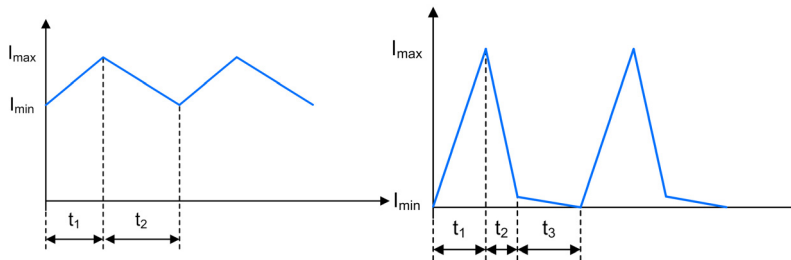

Figure 17.4.2. Full-Bridge - Inductor L_1 Current Waveforms in CCM and DCM

Average Inductor Current:
$$I_{L_1,avg} = \frac{I_{sec,max} + I_{sec,min}}{2} \cdot (t_1 + t_2) \cdot f_{switch}$$

Min. Inductor Current:
$$I_{L_1,min} = I_{sec,min}$$

Max. Inductor Current:
$$I_{L_1,max} = I_{sec,max}$$

Min. Inductor Current during t_3 :
$$I_{L_1,min,t_3} = I_{N_{s1/s2},min,t_3}$$

Max. Inductor Current during t_3 :
$$I_{L_1,max,t_3} = I_{N_{s1/s2},max,t_3}$$

Min. Inductor Voltage:
$$V_{L_1,min} = -V_{out} - V_f$$

Max. Inductor Voltage:
$$V_{L_1,max} = V_{in} \cdot \frac{n_s}{n_p} - V_f - V_{out}$$

Inductor Voltage during t_3 :
$$V_{L_1,t_3} = 0V$$

17.5. FET Q_1, Q_2, Q_3 & Q_4

17.5.1. CCM & DCM.

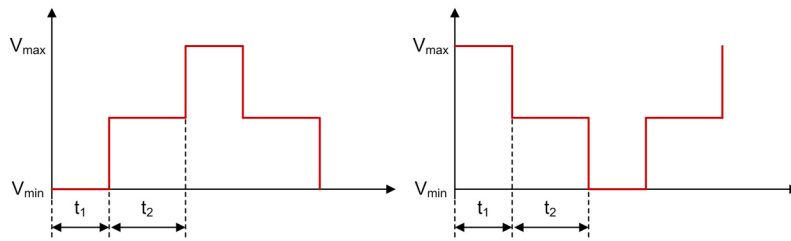

Figure 17.5.1. Full-Bridge - FETs Q_1/Q_3 and Q_2/Q_4 Voltage Waveforms in CCM

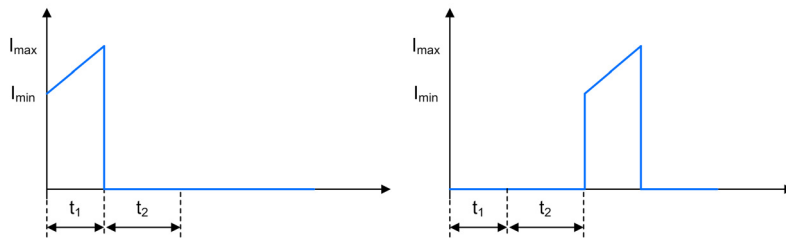

Figure 17.5.2. Full-Bridge - FETs Q_1/Q_3 and Q_2/Q_4 Current Waveforms in CCM

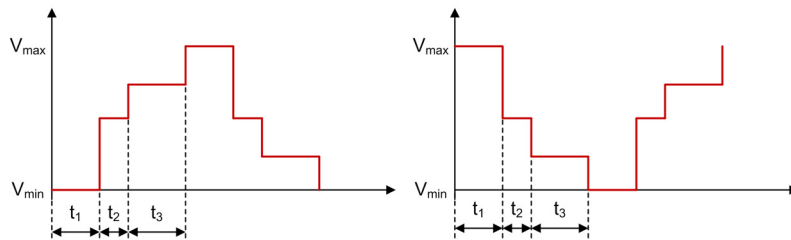

Figure 17.5.3. Full-Bridge - FETs Q_1/Q_3 and Q_2/Q_4 Voltage Waveforms in DCM

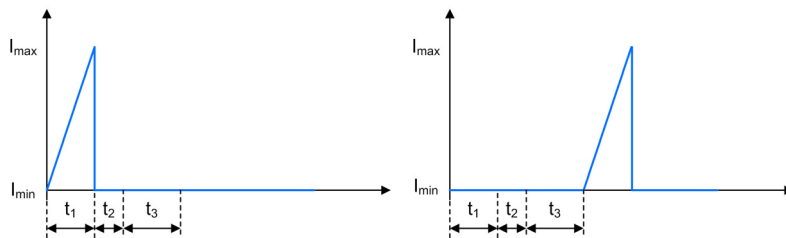

Figure 17.5.4. Full-Bridge - FETs Q_1/Q_3 and Q_2/Q_4 Current Waveforms in DCM

Average FET Current:	$I_{Q_{1/2/3/4},avg} = \frac{I_{pri,min} + I_{pri,max}}{2} \cdot t_1 \cdot f_{switch}$
Min. FET Current:	$I_{Q_{1/2/3/4},min} = I_{pri,min}$
Max. FET Current:	$I_{Q_{1/2/3/4},max} = I_{pri,max}$
Min. FET Voltage during t_1 :	$V_{Q_{1/2/3/4},min,t_1} = 0V$
Max. FET Voltage during t_1 (t_1 of other FET):	$V_{Q_{1/2/3/4},max,t_1} = V_{in}$
FET Voltage during t_2 :	$V_{Q_{1/2/3/4},t_2} = \frac{1}{2} \cdot V_{in}$
Min. FET Voltage during t_3 (t_3 of other FET):	$V_{Q_{1/2/3/4},min,t_3} = \frac{1}{2} \cdot \left[V_{in} - (V_{out} + V_f) \cdot \frac{n_p}{n_s} \right]$
Max. FET Voltage during t_3 :	$V_{Q_{1/2/3/4},max,t_3} = V_{in} - \frac{1}{2} \cdot \left[V_{in} + (V_{out} + V_f) \cdot \frac{n_p}{n_s} \right]$

17.6. Rectifier Diode D_1 & D_2

17.6.1. CCM & DCM.

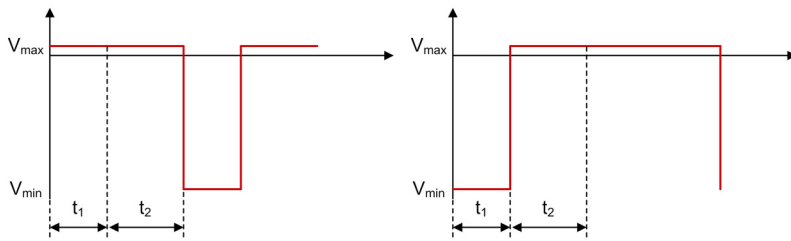

Figure 17.6.1. Full-Bridge - Rectifier Diodes D_1 and D_2 Voltage Waveforms in CCM

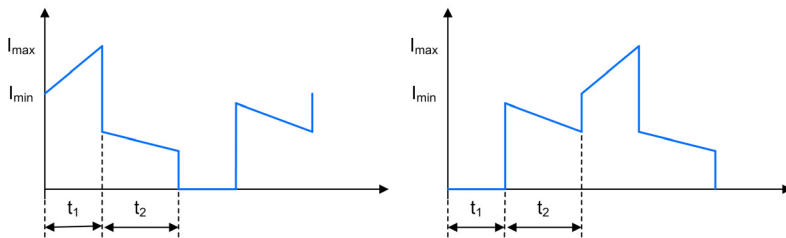

Figure 17.6.2. Full-Bridge - Rectifier Diodes D_1 and D_2 Current Waveforms in CCM

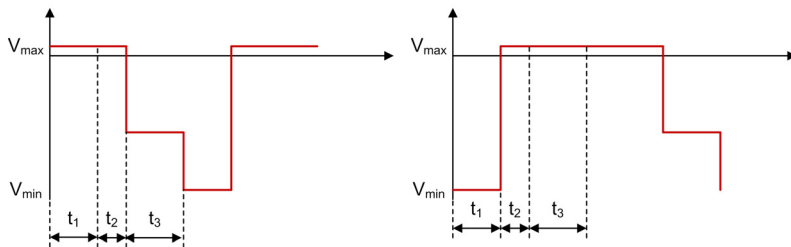

Figure 17.6.3. Full-Bridge - Rectifier Diodes D_1 and D_2 Voltage Waveforms in DCM

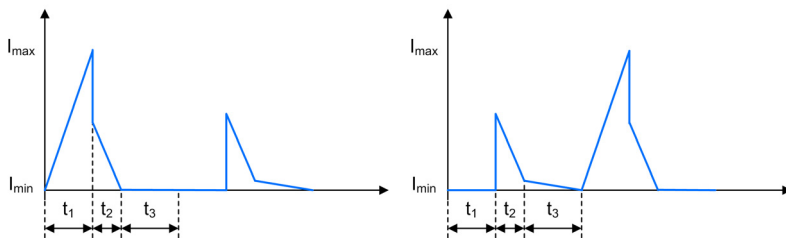

Figure 17.6.4. Full-Bridge - Rectifier Diodes D_1 and D_2 Current Waveforms in DCM

Average Rectifier Diode Current:	$I_{D_{1/2},avg} = I_{N_{s1/s2},avg}$
Min. Rectifier Diode Current (t_1 of FET):	$I_{D_{1/2},min} = I_{N_{s1/s2},min}$
Max. Rectifier Diode Current (t_1 of FET):	$I_{D_{1/2},max} = I_{N_{s1/s2},max}$
Min. Rectifier Diode Current (t_2 of other FET):	$I_{D_{1/2},min,t_2,other} = I_{N_{s1/s2},min,t_2,other}$
Max. Rectifier Diode Current (t_2 of other FET):	$I_{D_{1/2},max,t_2,other} = I_{N_{s1/s2},max,t_2,other}$
Min. Rectifier Diode Current (t_2 of FET):	$I_{D_{1/2},min,t_2} = I_{N_{s1/s2},min,t_2}$
Max. Rectifier Diode Current (t_2 of FET):	$I_{D_{1/2},max,t_2} = I_{N_{s1/s2},max,t_2}$
Min. Rectifier Diode Current (t_3 of other FET):	$I_{D_{1/2},min,t_3,other} = I_{N_{s1/s2},min,t_3}$
Max. Rectifier Diode Current (t_3 of other FET):	$I_{D_{1/2},max,t_3,other} = I_{N_{s1/s2},max,t_3}$
Rectifier Diode Current (t_3 of FET):	$I_{D_{1/2},t_3} = 0A$
Min. Rectifier Diode Voltage:	$V_{D_{1/2},min} = -2 \cdot V_{in} \cdot \frac{n_s}{n_p} + V_f$
Max. Rectifier Diode Voltage:	$V_{D_{1/2},max} = V_f$
Rectifier Diode Voltage during t_3 :	$V_{D_{1/2},t_3} = -2 \cdot V_{out}$

17.7. Input Capacitor C_i

17.7.1. CCM & DCM.

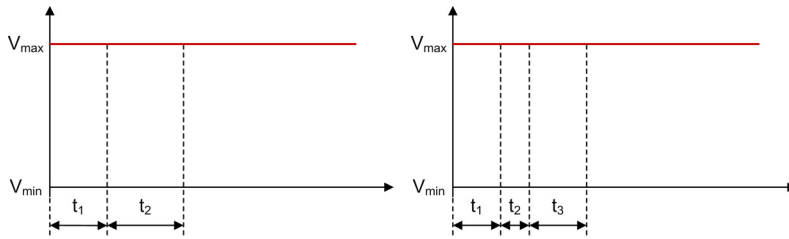

Figure 17.7.1. Full-Bridge - Input Capacitor C_i Voltage Waveforms in CCM and DCM

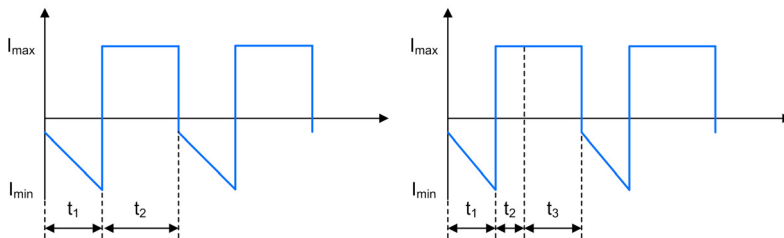

Figure 17.7.2. Full-Bridge - Input Capacitor C_i Current Waveforms in CCM and DCM

Min. Input Capacitor Current during t_1 : $I_{C_i,min,t_1} = 2 \cdot I_{Q_{1/2/3/4,avg}} - I_{pri,max}$

Max. Input Capacitor Current during t_1 : $I_{C_i,max,t_1} = 2 \cdot I_{Q_{1/2/3/4,avg}} - I_{pri,min}$

Input Capacitor Current during t_2 and t_3 : $I_{C_i,t_{2/3}} = 2 \cdot I_{Q_{1/2/3/4,avg}}$

Average Input Capacitor Current: $I_{C_i,avg} = 0A$

Input Capacitor Voltage: $V_{C_i} = V_{in}$

17.8. Output Capacitor C_o

17.8.1. CCM & DCM.

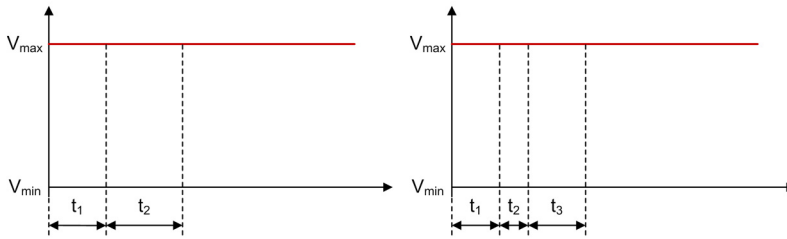

Figure 17.8.1. Full-Bridge - Output Capacitor C_o Voltage Waveforms in CCM and DCM

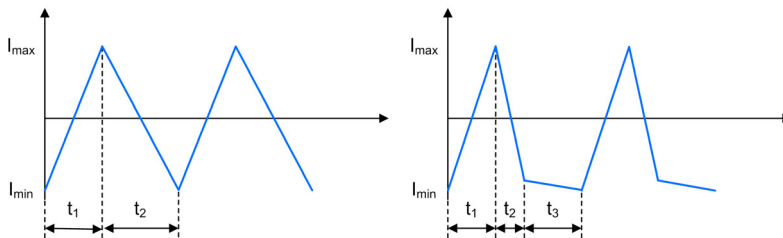

Figure 17.8.2. Full-Bridge - Output Capacitor C_o Current Waveforms in CCM and DCM

- Min. Output Capacitor Current: $I_{C_o,min} = I_{sec,min} - I_{out}$
- Max. Output Capacitor Current: $I_{C_o,max} = I_{sec,max} - I_{out}$
- Min. Output Capacitor Current during t_3 : $I_{C_o,min,t_3} = I_{sec,min} - I_{out}$
- Max. Output Capacitor Current during t_3 : $I_{C_o,max,t_3} = I_{N_{s1/s2,max,t_3}} - I_{out}$
- Average Output Capacitor Current: $I_{C_o,avg} = 0A$
- Output Capacitor Voltage: $V_{C_o} = V_{out}$

Phase-Shifted Full-Bridge Converter

A Phase-Shifted Full-Bridge regulator converts an input voltage to a higher or lower, positive or negative output voltage level. The energy is transferred to the output when the switches in one leg are both conducting. Calculations are made for Zero Voltage Switching (ZVS) between 50% and 100% load.

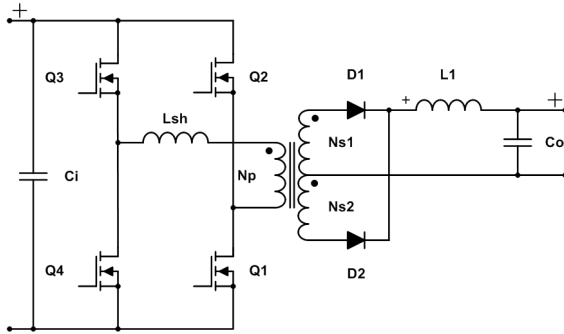

Figure 18.0.1. Schematic of a Phase-Shifted Full-Bridge converter

18.1. General

Secondary Side Inductance:

$$L_s = \frac{L_p}{\left(\frac{n_p}{n_s}\right)^2}$$

Voltage across primary Transformer Main Winding:

$$V_{N_p} = V_{in} \cdot \frac{L_p}{L_p + L_{sh}}$$

Inductor Current Ripple:

$$I_{ripple} = \frac{1}{L_1} \cdot (V_{N_p} \cdot \frac{n_s}{n_p} - V_f - V_{out}) \cdot t_1$$

18.1.1. Continuous Conduction Mode.

Duty Cycle Transformer:
$$D = \frac{V_{out} + V_f}{V_{N_p} \cdot \frac{n_s}{n_p}}$$

The duty cycle of the FETs is 50%.

FETs on, increasing current:
$$t_1 = \frac{1}{f_{switch}} \cdot \frac{D}{2}$$

FETs off, decreasing current:
$$t_2 = \frac{1}{f_{switch}} - t_1$$

Phaseshift-time:
$$t_3 = \frac{1}{2 \cdot f_{switch}} - t_1$$

Magnetization Current:
$$I_{mag} = \frac{V_{in} \cdot t_1}{L_p + L_{sh}}$$

Min. Secondary Current:
$$I_{sec,min} = I_{out} - \frac{1}{2} \cdot I_{ripple}$$

Max. Secondary Current:
$$I_{sec,max} = I_{out} + \frac{1}{2} \cdot I_{ripple}$$

Min. Primary Current:
$$I_{pri,min} = I_{sec,min} \cdot \frac{n_s}{n_p} - \frac{1}{2} \cdot I_{mag}$$

Max. Primary Current:
$$I_{pri,max} = I_{sec,max} \cdot \frac{n_s}{n_p} + \frac{1}{2} \cdot I_{mag}$$

Average Input Current:
$$I_{in,avg} = \frac{(V_{out} + V_f) \cdot I_{out}}{V_{in}}$$

18.2. Primary Side Transformer Winding N_p

18.2.1. CCM.

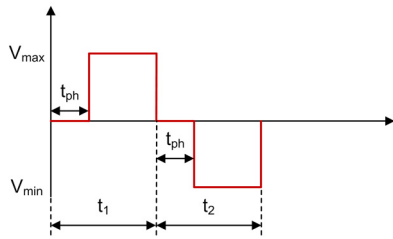

Figure 18.2.1. Phase-Shifted Full-Bridge - Primary Side Transformer Winding N_p Voltage Waveform in CCM

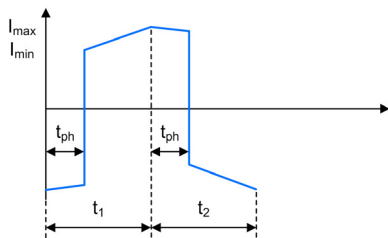

Figure 18.2.2. Phase-Shifted Full-Bridge - Primary Side Transformer Winding N_p Current Waveform in CCM

Average Primary Transformer Current:	$I_{N_p,avg} = 0A$
Min. Primary Transformer Current:	$I_{N_p,min} = I_{pri,min}$
Max. Primary Transformer Current:	$I_{N_p,max} = I_{pri,max}$
Primary Transformer Current (freewheeling):	$I_{N_p,min,fw} = I_{N_p,max} - \frac{I_{ripple}}{2 \cdot \frac{n_p}{n_s}}$
Min. Primary Transformer Voltage:	$V_{N_p,min} = -V_{N_p}$
Max. Primary Transformer Voltage:	$V_{N_p,max} = V_{N_p}$

18.3. Secondary Side Transformer Winding N_{s1} & N_{s2}

18.3.1. CCM.

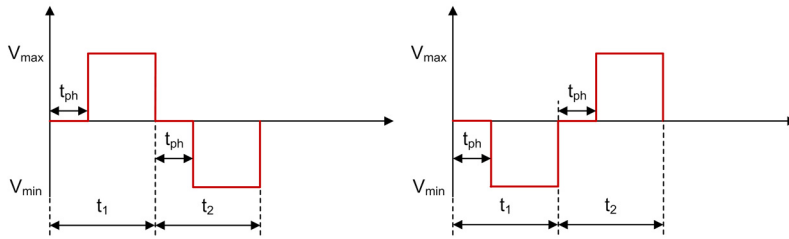

Figure 18.3.1. Phase-Shifted Full-Bridge - Secondary Side Transformer Windings N_{s1} and N_{s2} Voltage Waveforms in CCM

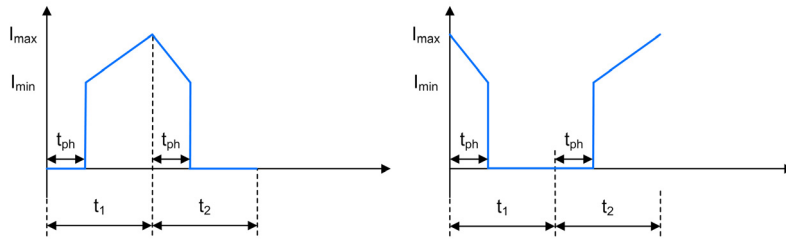

Figure 18.3.2. Phase-Shifted Full-Bridge - Secondary Side Transformer Windings N_{s1} and N_{s2} Current Waveforms in CCM

Min. Secondary Transformer Current: $I_{N_{s1/s2},min} = I_{sec,min}$

Max. Secondary Transformer Current: $I_{N_{s1/s2},max} = I_{sec,max}$

Average Secondary Transformer Current:

$$I_{N_{s1/s2},avg} = f_{switch} \cdot \left(\frac{I_{N_{s1/s2},min} + I_{N_{s1/s2},max}}{2} \cdot (t_1 - t_{ph}) + \frac{I_{N_{s1/s2},max} + I_{N_{s1/s2},min}}{2} \cdot t_{ph} \right)$$

Min. Secondary Transformer Voltage: $V_{N_{s1/s2},min} = -V_{N_p} \cdot \frac{n_s}{n_p}$

Max. Secondary Transformer Voltage: $V_{N_{s1/s2},max} = V_{N_p} \cdot \frac{n_s}{n_p}$

18.4. Inductor L_1

18.4.1. CCM.

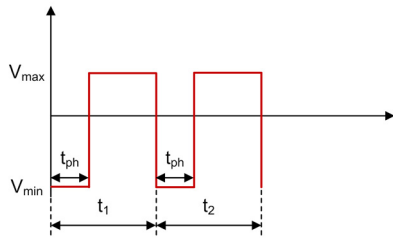

Figure 18.4.1. Phase-Shifted Full-Bridge - Inductor L_1 Voltage Waveform in CCM

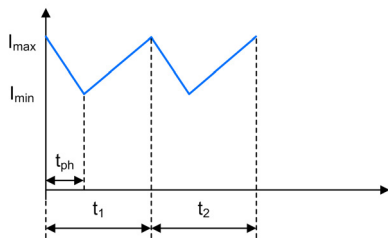

Figure 18.4.2. Phase-Shifted Full-Bridge - Inductor L_1 Current Waveform in CCM

Average Inductor Current:
$$I_{L_1,avg} = \frac{I_{sec,max} + I_{sec,min}}{2}$$

Min. Inductor Current:
$$I_{L_1,min} = I_{sec,min}$$

Max. Inductor Current:
$$I_{L_1,max} = I_{sec,max}$$

Min. Inductor Voltage:
$$V_{L_1,min} = -V_{out} - V_f$$

Max. Inductor Voltage:
$$V_{L_1,max} = V_{in} \cdot \frac{n_s}{n_p} - V_f - V_{out}$$

18.5. FET Q_1 , Q_2 , Q_3 & Q_4

18.5.1. CCM.

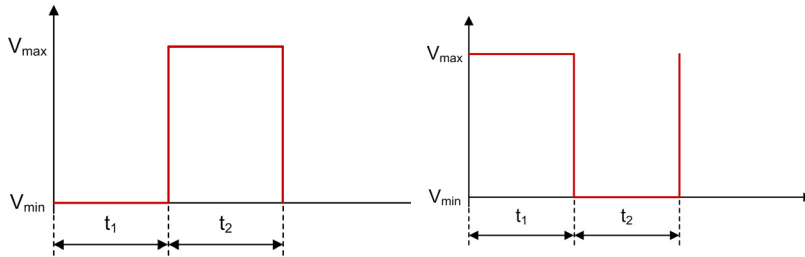

Figure 18.5.1. Phase-Shifted Full-Bridge - FETs Q_1 and Q_2 Voltage Waveforms in CCM

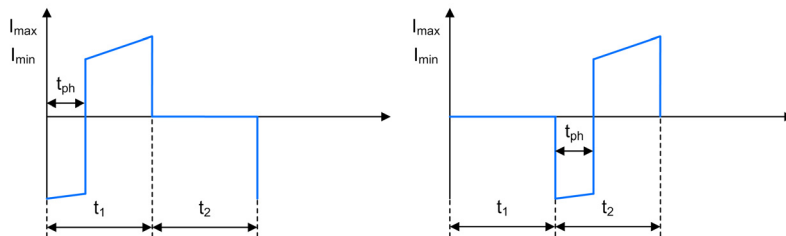

Figure 18.5.2. Phase-Shifted Full-Bridge - FETs Q_1 and Q_2 Current Waveforms in CCM

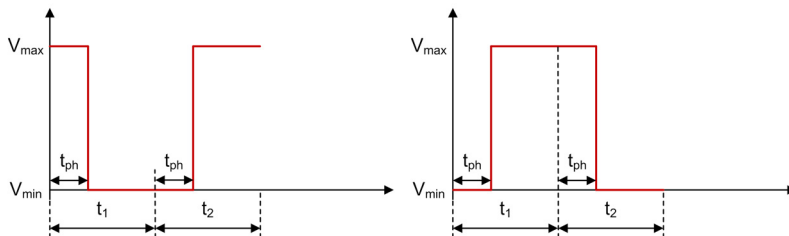

Figure 18.5.3. Phase-Shifted Full-Bridge - FETs Q_3 and Q_4 Voltage Waveforms in CCM

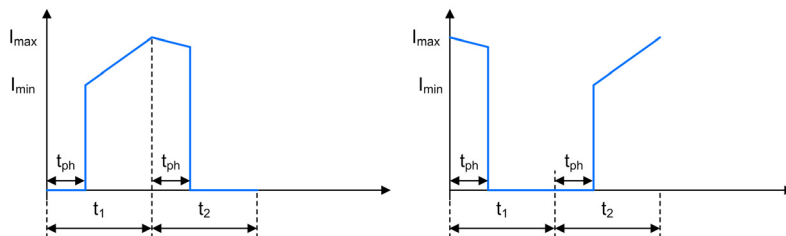

Figure 18.5.4. Phase-Shifted Full-Bridge - FETs Q_3 and Q_4 Current Waveforms in CCM

Min. FET Current (t_1 of FET, all FETs): $I_{Q_{1/2/3/4},min} = I_{pri,min}$

Max. FET Current (t_1 of FET, all FETs): $I_{Q_{1/2/3/4},max} = I_{pri,max}$

Min. FET Current (freewheeling, Q_3 & Q_4): $I_{Q_{3/4},min,t_{ph}} = I_{N_p,min}$

Max. FET Current (freewheeling, Q_3 & Q_4): $I_{Q_{3/4},max,t_{ph}} = I_{N_p,max}$

Min. FET Current (freewheeling, Q_1 & Q_2): $I_{Q_{1/2},min,t_{ph}} = -I_{N_p,max}$

Max. FET Current (freewheeling, Q_1 & Q_2): $I_{Q_{1/2},max,t_{ph}} = -I_{N_p,min}$

Average FET Current (Q_3 & Q_4):

$$I_{Q_{3/4},avg} = \left(\frac{I_{Q_{1/2/3/4},min} + I_{Q_{1/2/3/4},max}}{2} \cdot (t_1 - t_{ph}) + \frac{I_{Q_{3/4},min,t_{ph}} + I_{Q_{3/4},max,t_{ph}}}{2} \cdot t_{ph} \right) \cdot f_{switch}$$

Average FET Current (Q_1 & Q_2):

$$I_{Q_{1/2},avg} = \left(\frac{I_{Q_{1/2/3/4},min} + I_{Q_{1/2/3/4},max}}{2} \cdot (t_1 - t_{ph}) + \frac{I_{Q_{1/2},min,t_{ph}} + I_{Q_{1/2},max,t_{ph}}}{2} \cdot t_{ph} \right) \cdot f_{switch}$$

Min. FET Voltage: $V_{Q_{1/2/3/4},min} = 0V$

Max. FET Voltage: $V_{Q_{1/2/3/4},max} = V_{in}$

18.6. Rectifier Diodes D_1 & D_2

18.6.1. CCM.

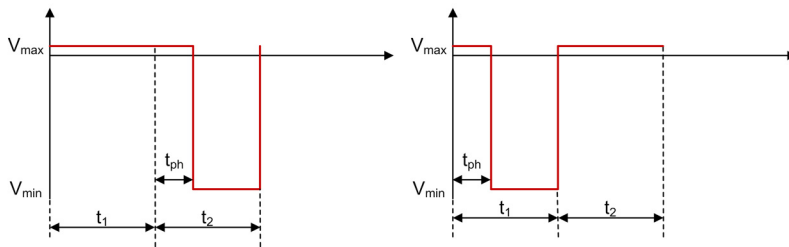

Figure 18.6.1. Phase-Shifted Full-Bridge - Rectifier Diodes D_1 and D_2 Voltage Waveforms in CCM

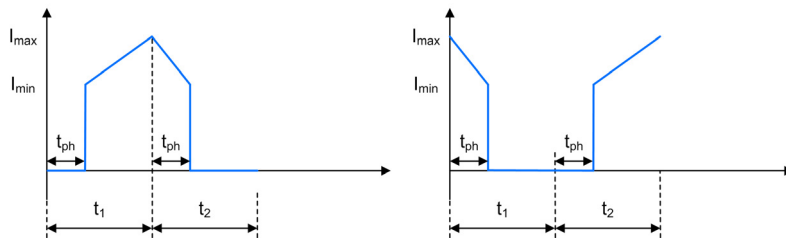

Figure 18.6.2. Phase-Shifted Full-Bridge - Rectifier Diodes D_1 and D_2 Current Waveforms in CCM

Average Rectifier Diode Current: $I_{D_{1/2},avg} = I_{N_{s1/s2},avg}$

Min. Rectifier Diode Current: $I_{D_{1/2},min} = I_{N_{s1/s2},min}$

Max. Rectifier Diode Current: $I_{D_{1/2},max} = I_{N_{s1/s2},max}$

Min. Rectifier Diode Voltage: $V_{D_{1/2},min} = -2 \cdot V_{N_p} \cdot \frac{n_s}{n_p} + V_f$

Max. Rectifier Diode Voltage: $V_{D_{1/2},max} = V_f$

18.7. Input Capacitor C_i

18.7.1. CCM.

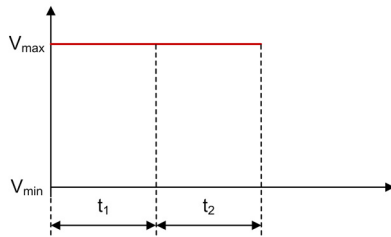

Figure 18.7.1. Phase-Shifted Full-Bridge - Input Capacitor C_i Voltage Waveform in CCM

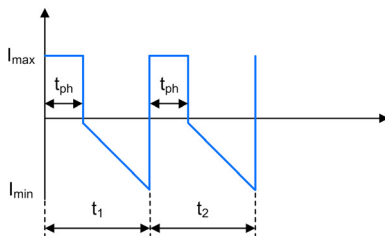

Figure 18.7.2. Phase-Shifted Full-Bridge - Input Capacitor C_i Current Waveform in CCM

Min. Input Capacitor Current during t_1 : $I_{C_i,min,t_1} = 2 \cdot I_{in,avg} - I_{N_p,max}$

Max. Input Capacitor Current during t_1 : $I_{C_i,max,t_1} = 2 \cdot I_{in,avg} - I_{N_p,min}$

Input Capacitor Current during t_2 : $I_{C_i,t_2} = 2 \cdot I_{in,avg}$

Average Input Capacitor Current: $I_{C_i,avg} = 0A$

Input Capacitor Voltage: $V_{C_i} = V_{in}$

18.8. Output Capacitor C_o

18.8.1. CCM.

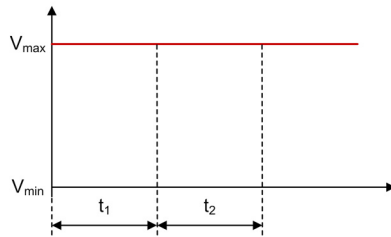

Figure 18.8.1. Phase-Shifted Full-Bridge - Output Capacitor C_o Voltage Waveform in CCM

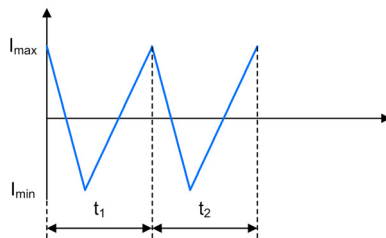

Figure 18.8.2. Phase-Shifted Full-Bridge - Output Capacitor C_o Current Waveform in CCM

Min. Output Capacitor Current: $I_{C_o,min} = I_{out} - I_{sec,max}$

Max. Output Capacitor Current: $I_{C_o,max} = I_{out} - I_{sec,min}$

Average Output Capacitor Current: $I_{C_o,avg} = 0A$

Output Capacitor Voltage: $V_{C_o} = V_{out}$

Speed time to market with powerful, easy-to-use design tools

Power Stage Designer

This tool helps design the power stage of switch mode power supply (SMPS) very quickly, and easily select components for it even for beginner designers.

To download Power Stage Designer visit ti.com/powerstagedesigner.

WEBENCH® Design Center

Use powerful WEBENCH design tools to create custom circuits. These easy-to-use tools deliver customized power, lighting, filtering, clocking and sensing designs in seconds.

To learn more about WEBENCH visit ti.com/webench.

TI Designs library

Engineers can jump-start their system designs with the TI Designs library of more than 2,000 reference designs. Our experts use TI integrated circuits to create innovative subsystem designs for industrial, automotive and personal electronics end equipment.

Search for your design at ti.com/tidesigns.

TI Training portal

For power training and technical content, visit ti.com/powertraining. This series of on-demand training provides an overview of the World of Power by Market, by Standard, by Product Type and Topology. It also provides an overview of the design tips and tools related to power design decisions.

The platform bar is a trademarks of Texas Instruments.
All other trademarks are the property of their respective owners.

Important Notice: The products and services of Texas Instruments Incorporated and its subsidiaries described herein are sold subject to TI's standard terms and conditions of sale. Customers are advised to obtain the most current and complete information about TI products and services before placing orders. TI assumes no liability for applications assistance, customer's applications or product designs, software performance, or infringement of patents. The publication of information regarding any other company's products or services does not constitute TI's approval, warranty or endorsement thereof.

IMPORTANT NOTICE AND DISCLAIMER

TI PROVIDES TECHNICAL AND RELIABILITY DATA (INCLUDING DATA SHEETS), DESIGN RESOURCES (INCLUDING REFERENCE DESIGNS), APPLICATION OR OTHER DESIGN ADVICE, WEB TOOLS, SAFETY INFORMATION, AND OTHER RESOURCES "AS IS" AND WITH ALL FAULTS, AND DISCLAIMS ALL WARRANTIES, EXPRESS AND IMPLIED, INCLUDING WITHOUT LIMITATION ANY IMPLIED WARRANTIES OF MERCHANTABILITY, FITNESS FOR A PARTICULAR PURPOSE OR NON-INFRINGEMENT OF THIRD PARTY INTELLECTUAL PROPERTY RIGHTS.

These resources are intended for skilled developers designing with TI products. You are solely responsible for (1) selecting the appropriate TI products for your application, (2) designing, validating and testing your application, and (3) ensuring your application meets applicable standards, and any other safety, security, regulatory or other requirements.

These resources are subject to change without notice. TI grants you permission to use these resources only for development of an application that uses the TI products described in the resource. Other reproduction and display of these resources is prohibited. No license is granted to any other TI intellectual property right or to any third party intellectual property right. TI disclaims responsibility for, and you will fully indemnify TI and its representatives against, any claims, damages, costs, losses, and liabilities arising out of your use of these resources.

TI's products are provided subject to [TI's Terms of Sale](#) or other applicable terms available either on [ti.com](https://www.ti.com) or provided in conjunction with such TI products. TI's provision of these resources does not expand or otherwise alter TI's applicable warranties or warranty disclaimers for TI products.

TI objects to and rejects any additional or different terms you may have proposed.

Mailing Address: Texas Instruments, Post Office Box 655303, Dallas, Texas 75265
Copyright © 2023, Texas Instruments Incorporated