

HP Pavilion 15 Repair

Steak Electronics

1 Overview

User spilled tonic water on a laptop, then kept it powered on and continued to use it (this was a mistake. Turning it off, and removing battery / power, letting the liquid dry, is always the first step in a spill). The next morning the laptop would not power on.

2 Equipment

Laptop is an HP Pavilion 15 CS model. They are fairly new (date codes on micros are from 2018), and retailing around 500-600 dollars as of just before

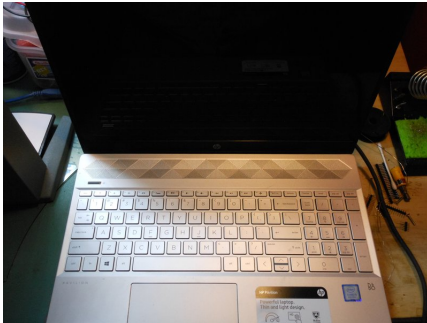

2019.

Figure 1: HP

3 Disassembly

There is no video tutorial on this online, but the steps are: Remove visible screws from the back of the case. Remove rubber feet, and screws beneath them. Pry open case from edges with plastic spudger tool to remove the clips. You must be careful, as the clips and case are fragile.

- Where to start with the spudger, and also showing the screwholes underneath the rubber feet.



Figure 2: Disassembly

- I was able to scratch the case with the plastic spudger. Be careful!

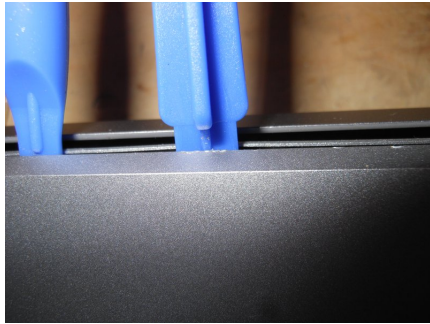

Figure 3: Disassembly

- The case can also crack from pulling it. I didn't pull this hard, but the brittle weak case cracked slightly.

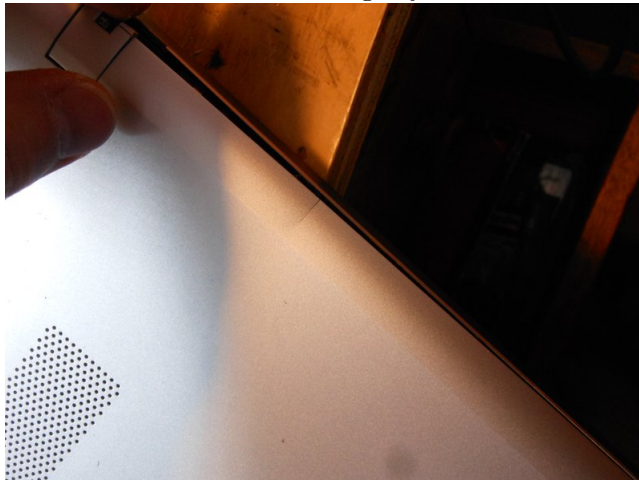

Figure 4: Disassembly

- Finally we are in.

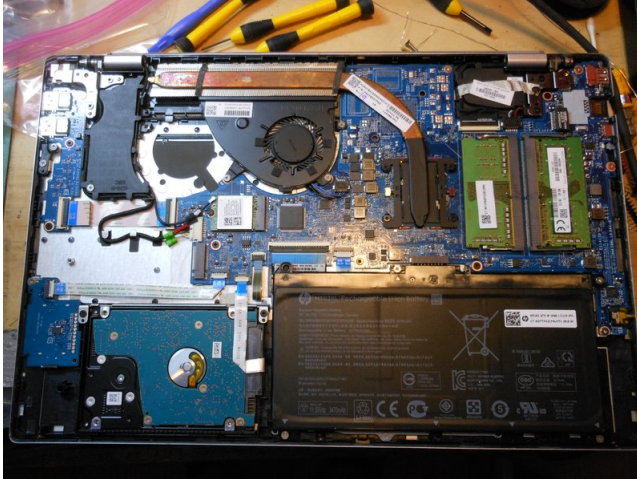

Figure 5: Disassembly

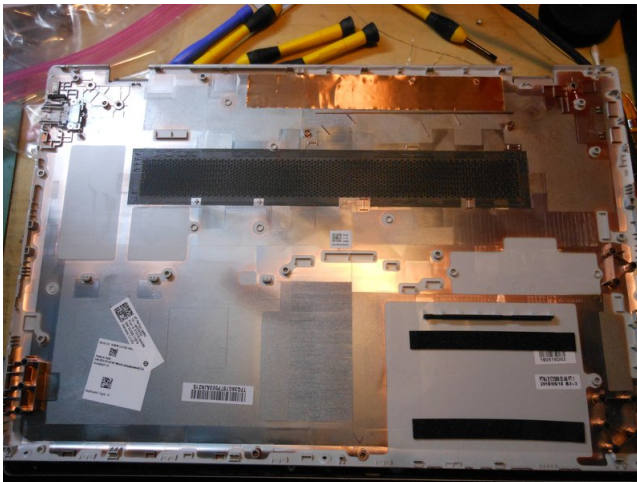

Figure 6: Disassembly

- Screws are labeled, to help illustrate what size each is:

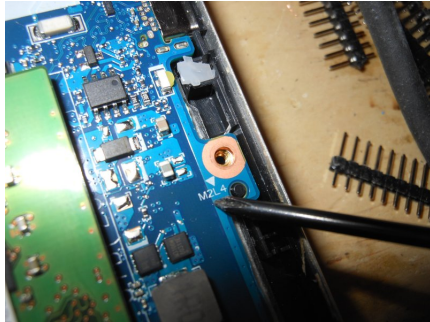

Figure 7: Disassembly

4 Diagnosis and Repair Log

Now we will try to find out what is wrong.

- Right away I can see some visible marring from a likely shorted component. This is where a lot of the soda residue is.



Figure 8: Repair

- You can see a layer of cellophane that is in place to protect against spills. Amazing how millions of man hours can go into designing computers, yet a single glass of liquid can destroy one. Something is wrong, here. Crazy.



Figure 9: Repair

- This switcher, the BACAAB (?) chip is the one that has the failed components. I need a replacement but can't find a data sheet on it. I tried probing at some of the pins to see what was going on, and if I could understand a bit more about this, but due to me probing too close to the pins, (and a few factors, primarily the small package, but no leads, and also the fact I should've used the pads NEAR but not ON the package, I shorted something, and a spark resulted. While I saw a 2.4V signal on a pin, after the short, I was unable to find anything. The battery being removed and replaced did not bring it back.

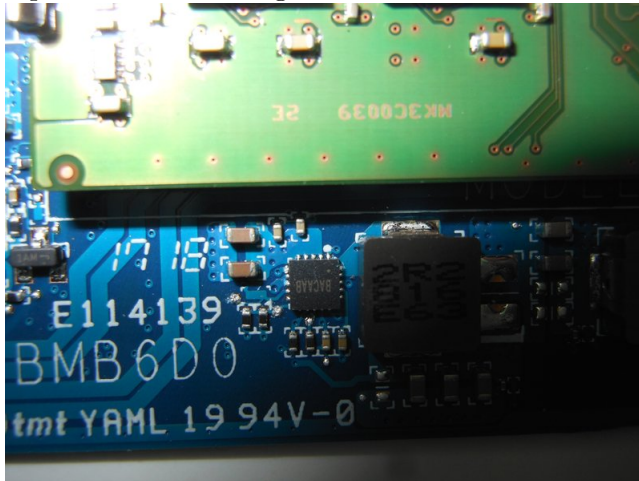

Figure 10: Repair

- At this point, this chip, which I am unsure of what it is, appears to have a short and is overheating / shorting. I will need to get a motherboard donor at this point, to further repair the mistakes. As these are new boards, motherboards are not yet cheap enough to make this viable, so I will wait and try again at a later date.

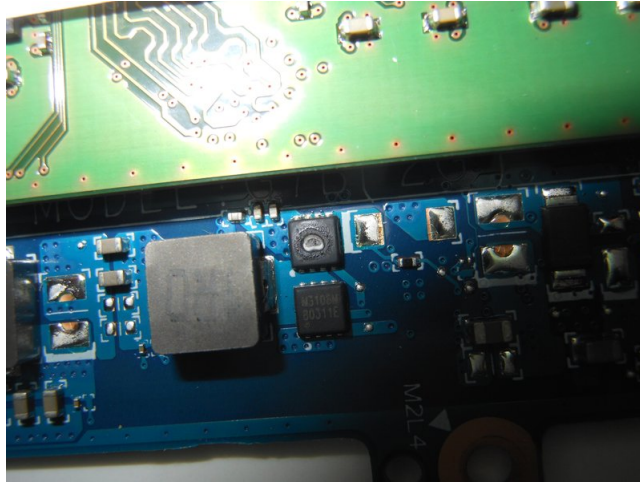

Figure 11: Repair

- During my troubleshooting, I did find an open resistor, and a capacitor that has visible charring on its solder joint. I'll need to replace these as well. I should've replaced this at first, but without a schematic, I don't know what value the cap should be. The resistor is labeled as 1R0, but reads open. There may also be one other cap that has failed. However, some other components appear OK.

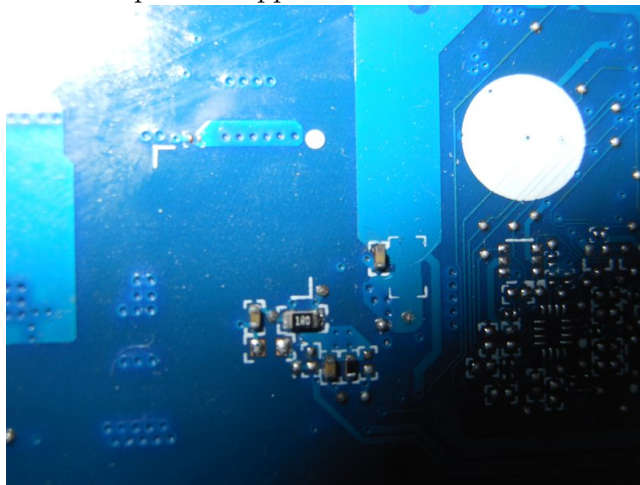

Figure 12: Site of failed components from soda water spill.

5 Day Two

I've received another motherboard in the mail. Unfortunately, I can NOT get the schematic for this motherboard, but I have an earlier HP version available. Maybe this is why people such as L. Rossman are successful - they focus on Apple, which has available schematic and layout... I have no layout either.

Looking at this similar schematic, it's important to focus on what matters. checking power rails, I know I need to start at the beginning. Also, when looking at other schematics outside of the power rails you can see what inputs into them and what is relevant.

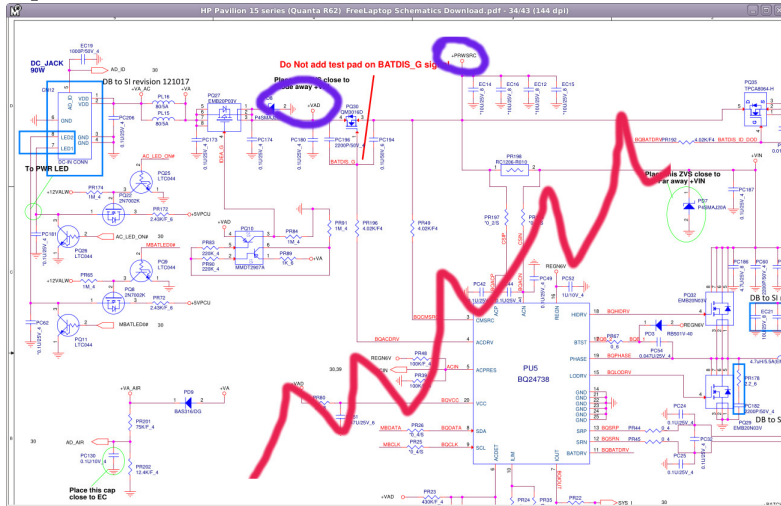

Figure 13: I'm worried about the AC adapter input. All the battery circuitry can be ignored to start, as there is no battery. First I need to follow PRWSRC and VAD...

Interestingly, there is a discharge IC. A IC for discharging caps. New to me. They call it a charge pump on the G5934 data sheet, but schematic says Discharge IC... I think same thing. There are discharge pins on the G5934.