

LM330-N 3-Terminal Positive Regulator

Check for Samples: [LM330-N](#)

FEATURES

- Input-output Differential Less than 0.6V
- Output Current of 150 mA
- Reverse Battery Protection
- Line Transient Protection
- Internal Short Circuit Current Limit
- Internal Thermal Overload Protection
- Mirror-image Insertion Protection
- P⁺ Product Enhancement Tested

DESCRIPTION

The LM330-N 5V 3-terminal positive voltage regulator features an ability to source 150 mA of output current with an input-output differential of 0.6V or less. Familiar regulator features such as current limit and thermal overload protection are also provided.

The low dropout voltage makes the LM330-N useful for certain battery applications since this feature allows a longer battery discharge before the output falls out of regulation. For example, a battery supplying the regulator input voltage may discharge to 5.6V and still properly regulate the system and load voltage. Supporting this feature, the LM330-N protects both itself and regulated systems from negative voltage inputs resulting from reverse installations of batteries.

Other protection features include line transient protection up to 26V, when the output actually shuts down to avoid damaging internal and external circuits. Also, the LM330-N regulator cannot be harmed by a temporary mirror-image insertion.

Schematic and Connection Diagrams

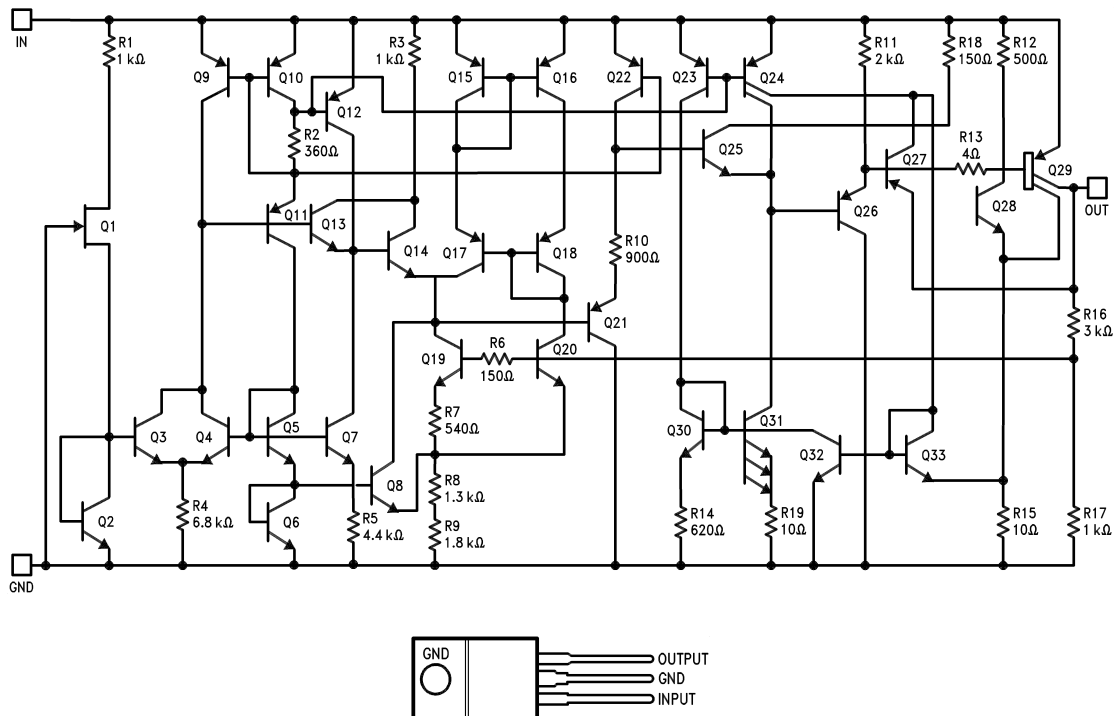

**Figure 1. (TO-220)
Plastic Package
Front View
See Package Number NDE0003B**



Please be aware that an important notice concerning availability, standard warranty, and use in critical applications of Texas Instruments semiconductor products and disclaimers thereto appears at the end of this data sheet.

All trademarks are the property of their respective owners.



These devices have limited built-in ESD protection. The leads should be shorted together or the device placed in conductive foam during storage or handling to prevent electrostatic damage to the MOS gates.

Absolute Maximum Ratings⁽¹⁾⁽²⁾

Input Voltage	
Operating Range	26V
Line Transient Protection (1000 ms)	40V
Internal Power Dissipation	Internally Limited
Operating Temperature Range	0°C to +70°C
Maximum Junction Temperature	+125°C
Storage Temperature Range	-65°C to +150°C
Lead Temperature	
(Soldering, 10 sec.)	+300°C

- (1) "Absolute Maximum Ratings" indicate limits beyond which damage to the device may occur. Operating Ratings indicate conditions for which the device is functional, but do not ensure specific performance limits.
- (2) If Military/Aerospace specified devices are required, please contact the Texas Instruments Sales Office/Distributors for availability and specifications.

Electrical Characteristics⁽¹⁾

Symbol	Parameter	Conditions	Min	Typ	Max	Units
V_o	Output Voltage	$T_j = 25^\circ\text{C}$	4.8	5	5.2	V
	Output Voltage Over Temp	$5 < I_o < 150 \text{ mA}$ $6 < V_{IN} < 26\text{V}; 0^\circ\text{C} \leq T_j \leq 100^\circ\text{C}$	4.75		5.25	
ΔV_o	Line Regulation	$9 < V_{IN} < 16\text{V}, I_o = 5 \text{ mA}$ $6 < V_{IN} < 26\text{V}, I_o = 5 \text{ mA}$		7 30	25 60	mV
	Load Regulation	$5 < I_o < 150 \text{ mA}$		14	50	
	Long Term Stability			20		mV/1000 hrs
I_Q	Quiescent Current	$I_o = 10 \text{ mA}$ $I_o = 50 \text{ mA}$ $I_o = 150 \text{ mA}$		3.5 5 18	7 11 40	mA
	Line Transient Reverse Polarity	$V_{IN} = 40\text{V}, R_L = 100\Omega, 1\text{s}$ $V_{IN} = -6\text{V}, R_L = 100\Omega$		14 -80		
ΔI_Q	Quiescent Current Change	$6 < V_{IN} < 26\text{V}$		10		%
V_{IN}	Overvoltage Shutdown Voltage		26	38		V
	Max Line Transient			60		
		1s, $V_o \leq 5.5\text{V}$		50		
	Reverse Polarity Input Voltage	DC $V_o > -0.3\text{V}, R_L = 100\Omega$		-30 -12		
	Output Noise Voltage	10 Hz–100 kHz		50		μV
	Output Impedance	$I_o = 100 \text{ mADC} + 10 \text{ mArms}$		200		$\text{m}\Omega$
	Ripple Rejection			56		dB
	Current Limit		150	400	700	mA
	Dropout Voltage	$I_o = 150 \text{ mA}$		0.32	0.6	V
	Thermal Resistance	Junction to Case		4		$^\circ\text{C}/\text{W}$
		Junction to Ambient		50		

- (1) Unless otherwise specified: $V_{IN} = 14\text{V}$, $I_o = 150 \text{ mA}$, $T_j = 25^\circ\text{C}$, $C1 = 0.1 \mu\text{F}$, $C2 = 10 \mu\text{F}$. All characteristics except noise voltage and ripple rejection are measured using pulse techniques ($t_w \leq 10 \text{ ms}$, duty cycle $\leq 5\%$). Output voltage changes due to changes in internal temperature must be taken into account separately.

Typical Performance Characteristics

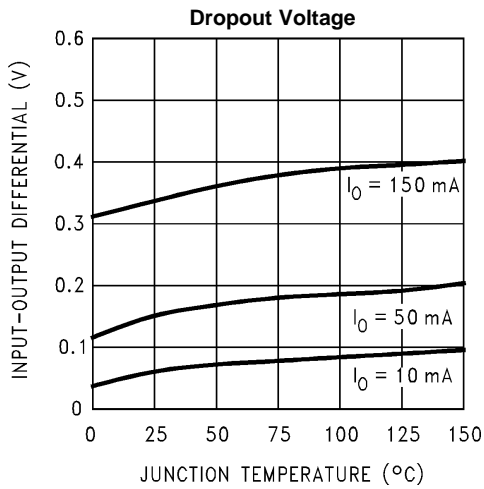

Figure 2.

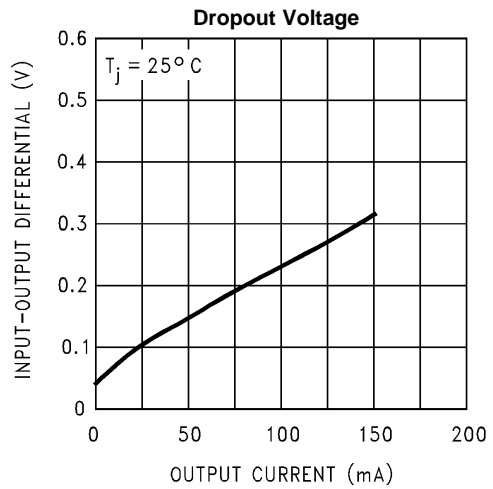

Figure 3.

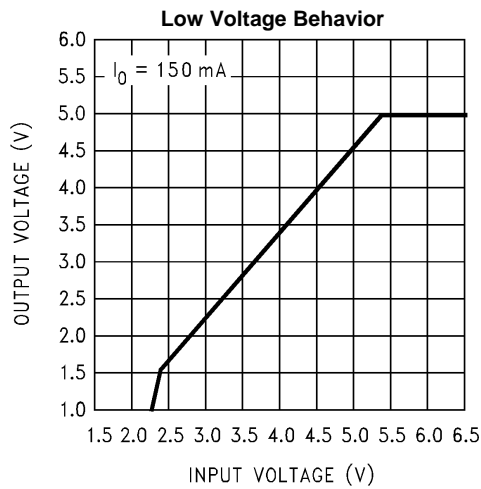

Figure 4.

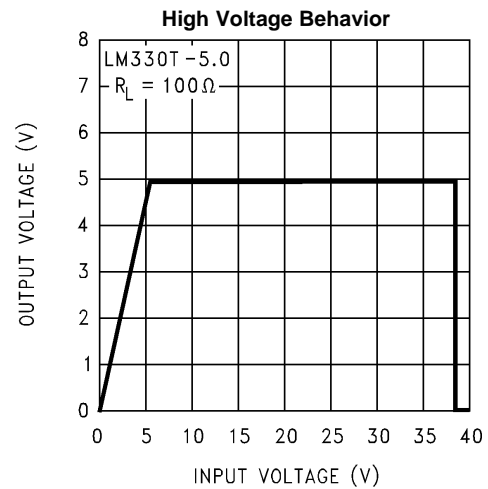

Figure 5.

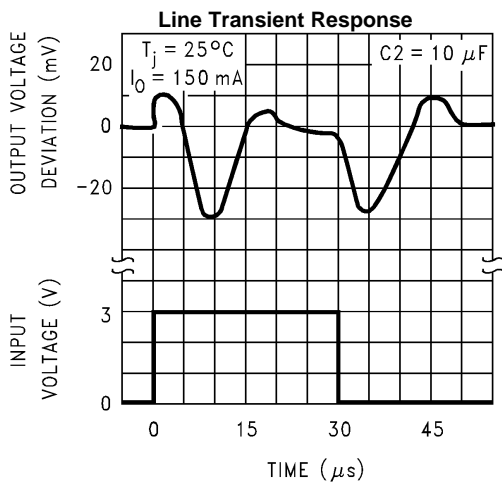

Figure 6.

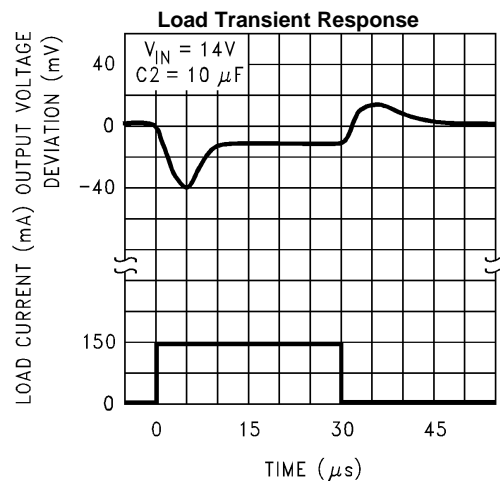

Figure 7.

Typical Performance Characteristics (continued)

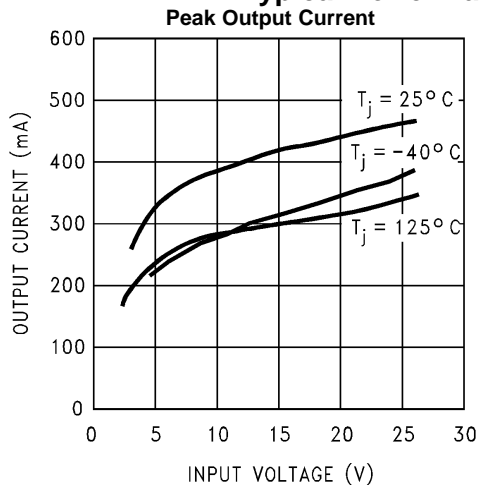

Figure 8.

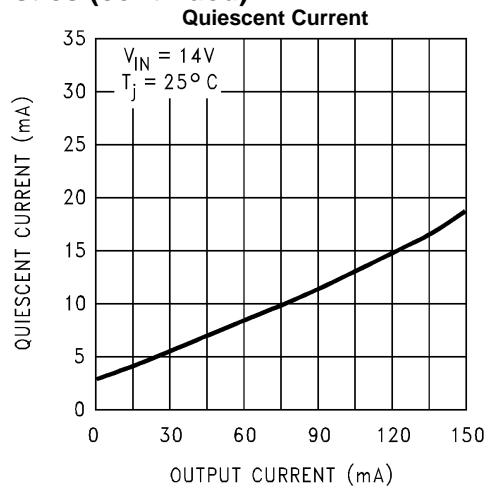

Figure 9.

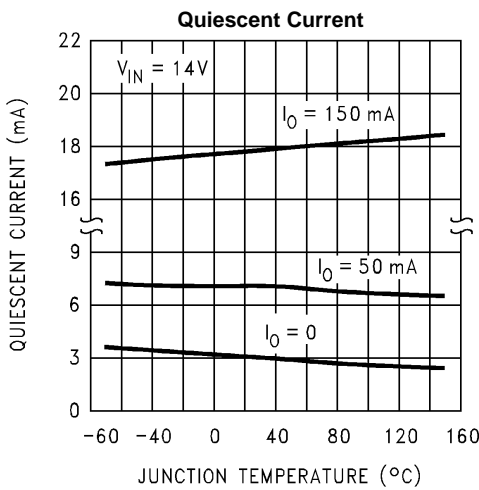

Figure 10.

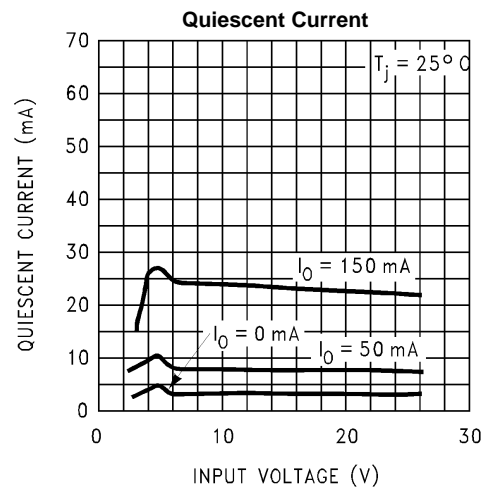

Figure 11.

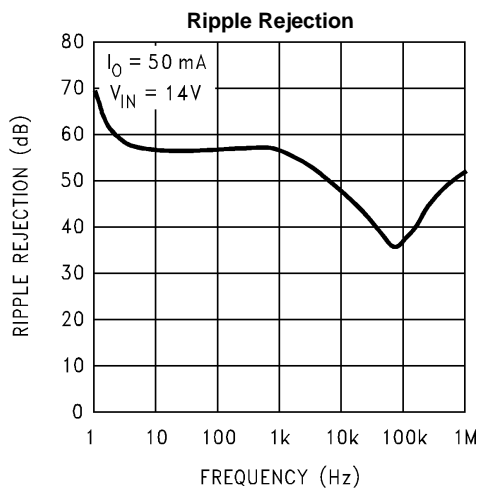

Figure 12.

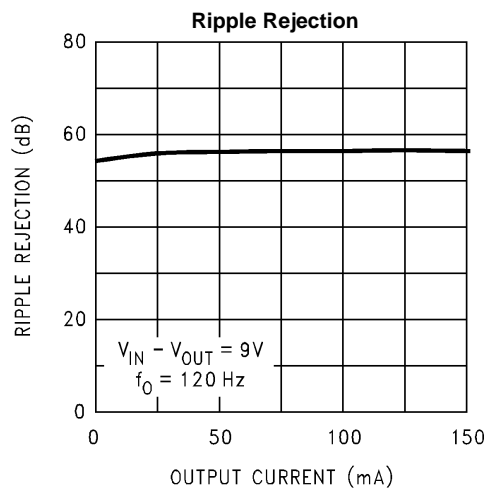

Figure 13.

Typical Performance Characteristics (continued)

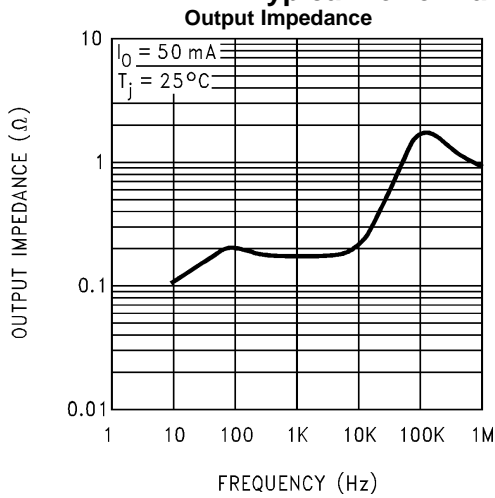

Figure 14.

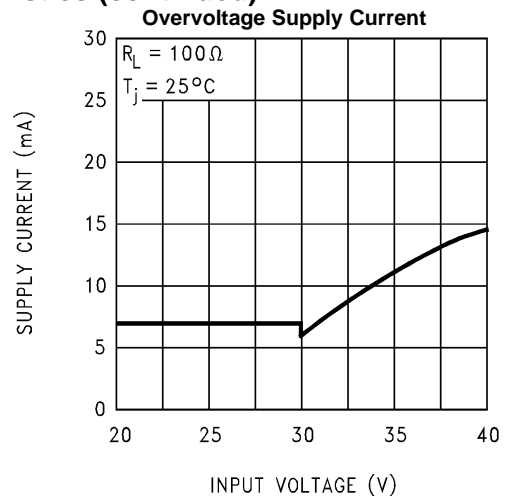

Figure 15.

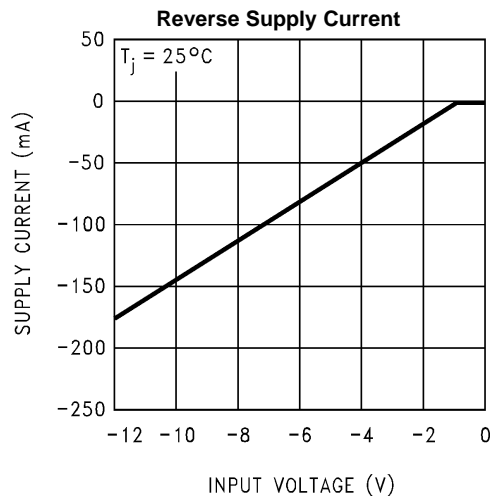

Figure 16.

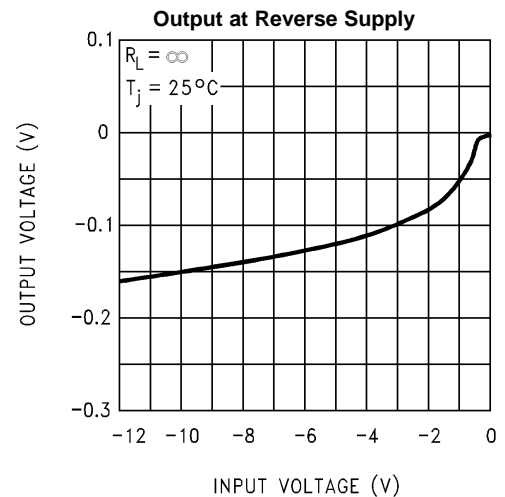

Figure 17.

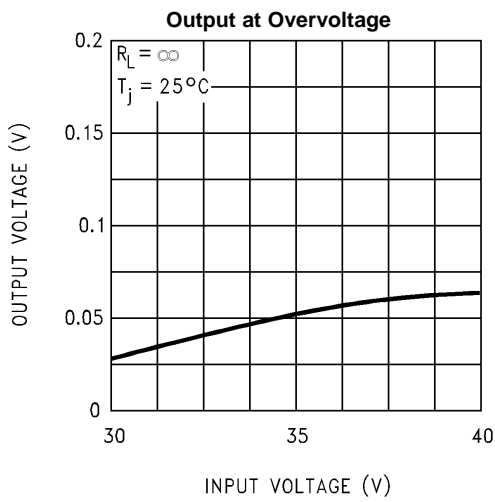

Figure 18.

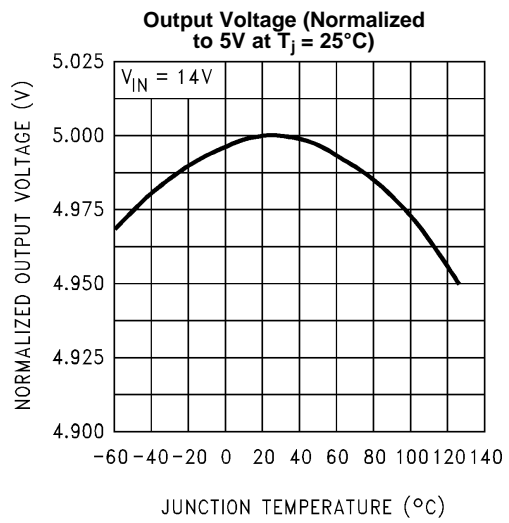
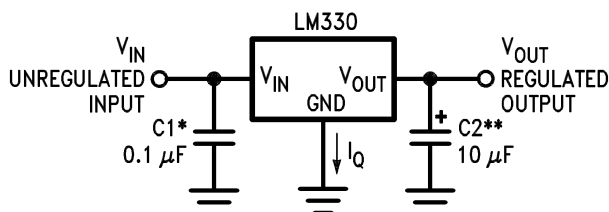

Figure 19.

TYPICAL APPLICATIONS

The LM330-N is designed specifically to operate at lower input to output voltages. The device is designed utilizing a power lateral PNP transistor which reduces dropout voltage from 2.0V to 0.3V when compared to IC regulators using NPN pass transistors. Since the LM330-N can operate at a much lower input voltage, the device power dissipation is reduced, heat sinking can be simpler and device reliability improved through lower chip operating temperature. Also, a cost savings can be utilized through use of lower power/voltage components. In applications utilizing battery power, the LM330-N allows the battery voltage to drop to within 0.3V of output voltage prior to the voltage regulator dropping out of regulation.



* Required if regulator is located far from power supply filter.

** C2 may be either an Aluminum or Tantalum type capacitor but must be rated to operate at -40°C to ensure regulator stability to that temperature extreme. 10 μF is the minimum value required for stability and may be increased without bound. Locate as close as possible to the regulation.

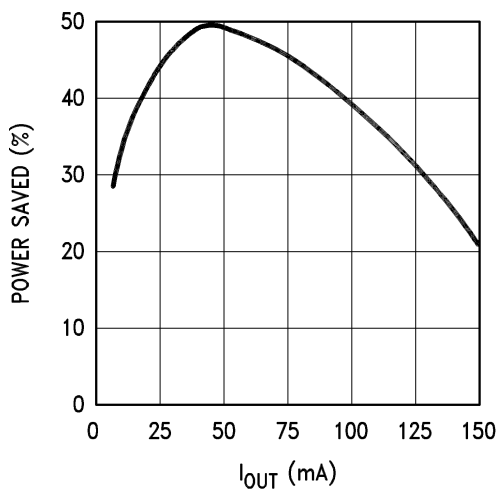

Note: Compared to IC regulator with 2.0V dropout voltage and $I_{Qmax} = 6.0$ mA.

REVISION HISTORY

Changes from Revision C (March 2013) to Revision D	Page
<hr/> <ul style="list-style-type: none">• Changed layout of National Data Sheet to TI format	<hr/> 6

PACKAGING INFORMATION

Orderable Device	Status (1)	Package Type	Package Drawing	Pins	Package Qty	Eco Plan (2)	Lead/Ball Finish (6)	MSL Peak Temp (3)	Op Temp (°C)	Device Marking (4/5)	Samples
LM330T-5.0/NOPB	ACTIVE	TO-220	NDE	3	45	Green (RoHS & no Sb/Br)	CU SN	Level-1-NA-UNLIM	0 to 70	LM330T -5.0	Samples

(1) The marketing status values are defined as follows:

ACTIVE: Product device recommended for new designs.

LIFEBUY: TI has announced that the device will be discontinued, and a lifetime-buy period is in effect.

NRND: Not recommended for new designs. Device is in production to support existing customers, but TI does not recommend using this part in a new design.

PREVIEW: Device has been announced but is not in production. Samples may or may not be available.

OBSELETE: TI has discontinued the production of the device.

(2) Eco Plan - The planned eco-friendly classification: Pb-Free (RoHS), Pb-Free (RoHS Exempt), or Green (RoHS & no Sb/Br) - please check <http://www.ti.com/productcontent> for the latest availability information and additional product content details.

TBD: The Pb-Free/Green conversion plan has not been defined.

Pb-Free (RoHS): TI's terms "Lead-Free" or "Pb-Free" mean semiconductor products that are compatible with the current RoHS requirements for all 6 substances, including the requirement that lead not exceed 0.1% by weight in homogeneous materials. Where designed to be soldered at high temperatures, TI Pb-Free products are suitable for use in specified lead-free processes.

Pb-Free (RoHS Exempt): This component has a RoHS exemption for either 1) lead-based flip-chip solder bumps used between the die and package, or 2) lead-based die adhesive used between the die and leadframe. The component is otherwise considered Pb-Free (RoHS compatible) as defined above.

Green (RoHS & no Sb/Br): TI defines "Green" to mean Pb-Free (RoHS compatible), and free of Bromine (Br) and Antimony (Sb) based flame retardants (Br or Sb do not exceed 0.1% by weight in homogeneous material)

(3) MSL, Peak Temp. - The Moisture Sensitivity Level rating according to the JEDEC industry standard classifications, and peak solder temperature.

(4) There may be additional marking, which relates to the logo, the lot trace code information, or the environmental category on the device.

(5) Multiple Device Markings will be inside parentheses. Only one Device Marking contained in parentheses and separated by a "~" will appear on a device. If a line is indented then it is a continuation of the previous line and the two combined represent the entire Device Marking for that device.

(6) Lead/Ball Finish - Orderable Devices may have multiple material finish options. Finish options are separated by a vertical ruled line. Lead/Ball Finish values may wrap to two lines if the finish value exceeds the maximum column width.

Important Information and Disclaimer:The information provided on this page represents TI's knowledge and belief as of the date that it is provided. TI bases its knowledge and belief on information provided by third parties, and makes no representation or warranty as to the accuracy of such information. Efforts are underway to better integrate information from third parties. TI has taken and continues to take reasonable steps to provide representative and accurate information but may not have conducted destructive testing or chemical analysis on incoming materials and chemicals. TI and TI suppliers consider certain information to be proprietary, and thus CAS numbers and other limited information may not be available for release.

In no event shall TI's liability arising out of such information exceed the total purchase price of the TI part(s) at issue in this document sold by TI to Customer on an annual basis.

NDE0003B

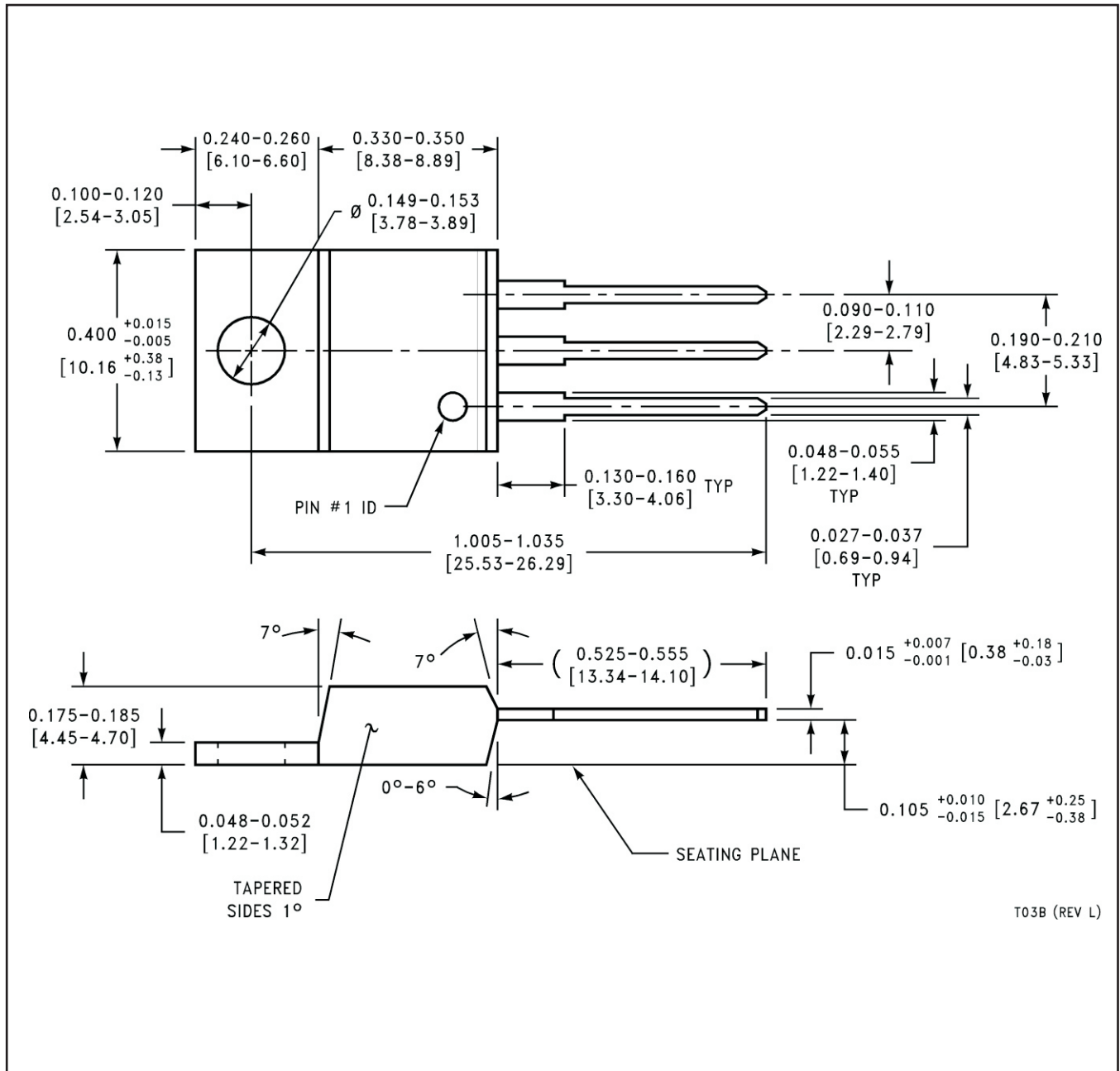

IMPORTANT NOTICE

Texas Instruments Incorporated and its subsidiaries (TI) reserve the right to make corrections, enhancements, improvements and other changes to its semiconductor products and services per JESD46, latest issue, and to discontinue any product or service per JESD48, latest issue. Buyers should obtain the latest relevant information before placing orders and should verify that such information is current and complete. All semiconductor products (also referred to herein as "components") are sold subject to TI's terms and conditions of sale supplied at the time of order acknowledgment.

TI warrants performance of its components to the specifications applicable at the time of sale, in accordance with the warranty in TI's terms and conditions of sale of semiconductor products. Testing and other quality control techniques are used to the extent TI deems necessary to support this warranty. Except where mandated by applicable law, testing of all parameters of each component is not necessarily performed.

TI assumes no liability for applications assistance or the design of Buyers' products. Buyers are responsible for their products and applications using TI components. To minimize the risks associated with Buyers' products and applications, Buyers should provide adequate design and operating safeguards.

TI does not warrant or represent that any license, either express or implied, is granted under any patent right, copyright, mask work right, or other intellectual property right relating to any combination, machine, or process in which TI components or services are used. Information published by TI regarding third-party products or services does not constitute a license to use such products or services or a warranty or endorsement thereof. Use of such information may require a license from a third party under the patents or other intellectual property of the third party, or a license from TI under the patents or other intellectual property of TI.

Reproduction of significant portions of TI information in TI data books or data sheets is permissible only if reproduction is without alteration and is accompanied by all associated warranties, conditions, limitations, and notices. TI is not responsible or liable for such altered documentation. Information of third parties may be subject to additional restrictions.

Resale of TI components or services with statements different from or beyond the parameters stated by TI for that component or service voids all express and any implied warranties for the associated TI component or service and is an unfair and deceptive business practice. TI is not responsible or liable for any such statements.

Buyer acknowledges and agrees that it is solely responsible for compliance with all legal, regulatory and safety-related requirements concerning its products, and any use of TI components in its applications, notwithstanding any applications-related information or support that may be provided by TI. Buyer represents and agrees that it has all the necessary expertise to create and implement safeguards which anticipate dangerous consequences of failures, monitor failures and their consequences, lessen the likelihood of failures that might cause harm and take appropriate remedial actions. Buyer will fully indemnify TI and its representatives against any damages arising out of the use of any TI components in safety-critical applications.

In some cases, TI components may be promoted specifically to facilitate safety-related applications. With such components, TI's goal is to help enable customers to design and create their own end-product solutions that meet applicable functional safety standards and requirements. Nonetheless, such components are subject to these terms.

No TI components are authorized for use in FDA Class III (or similar life-critical medical equipment) unless authorized officers of the parties have executed a special agreement specifically governing such use.

Only those TI components which TI has specifically designated as military grade or "enhanced plastic" are designed and intended for use in military/aerospace applications or environments. Buyer acknowledges and agrees that any military or aerospace use of TI components which have **not** been so designated is solely at the Buyer's risk, and that Buyer is solely responsible for compliance with all legal and regulatory requirements in connection with such use.

TI has specifically designated certain components as meeting ISO/TS16949 requirements, mainly for automotive use. In any case of use of non-designated products, TI will not be responsible for any failure to meet ISO/TS16949.

Products

Audio	www.ti.com/audio
Amplifiers	amplifier.ti.com
Data Converters	dataconverter.ti.com
DLP® Products	www.dlp.com
DSP	dsp.ti.com
Clocks and Timers	www.ti.com/clocks
Interface	interface.ti.com
Logic	logic.ti.com
Power Mgmt	power.ti.com
Microcontrollers	microcontroller.ti.com
RFID	www.ti-rfid.com
OMAP Applications Processors	www.ti.com/omap
Wireless Connectivity	www.ti.com/wirelessconnectivity

Applications

Automotive and Transportation	www.ti.com/automotive
Communications and Telecom	www.ti.com/communications
Computers and Peripherals	www.ti.com/computers
Consumer Electronics	www.ti.com/consumer-apps
Energy and Lighting	www.ti.com/energy
Industrial	www.ti.com/industrial
Medical	www.ti.com/medical
Security	www.ti.com/security
Space, Avionics and Defense	www.ti.com/space-avionics-defense
Video and Imaging	www.ti.com/video

TI E2E Community

e2e.ti.com